

**PATTERNS OF RELATIONSHIP BETWEEN
BANANA (*Musa* spp.) TYPES AND THE BANANA
WEEVIL, *Cosmopolites sordidus*
(GERMAR)(COLEOPTERA: CURCULIONIDAE)**

BY

ALFRED JOSEPH SUMANI

(Dip. Agric., Lusaka; Dip. Insect Tax., Cardiff; M.Phil., Cardiff)

**A DISSERTATION SUBMITTED TO THE UNIVERSITY OF ZAMBIA IN
PARTIAL FULFILMENT OF THE REQUIREMENTS OF THE
DEGREE OF DOCTOR OF PHILOSOPHY IN BIOLOGY
(ENTOMOLOGY)**

© THE UNIVERSITY OF ZAMBIA
LUSAKA
1997
254713

DECLARATION

I, Alfred Joseph Sumani, declare that this dissertation is my original work and has not been presented for a degree in any other University.

SIGNATURE _____

A. J. SUMANI

DATE _____

7-8-97

APPROVAL

This thesis of Mr. Alfred Joseph Sumani is approved as fulfilling the requirements for the award of the degree of Doctor of Philosophy in Biology (Entomology) by the University of Zambia.

Signature:

Date:

K. K. Banda.....

22.11.1996....

M. Long.....

30/05/97....

[Signature].....

09.10.97....

.....

.....

QUOTATION

What was, will be again,
what has been done, will be done again,
and there is nothing new under the sun!

Ecclesiastes 1:9

DEDICATION

My sister, OLIPA, 'till we meet again

TABLE OF CONTENTS

	PAGE
Title	i
Declaration	ii
Approval	iii
Quotation	iv
Dedication	v
Table of contents	vi
List of tables	x
List of figures	xi
List of plates	xii
Acknowledgements	xiii
Abstract	xiv
Chapter 1. Introduction	1
1.1. Origin and significance of banana crop	1
1.2. Statement of the problem	2
1.3. Objectives of the study	4
1.3.1 Broad objective	4
1.3.2 Specific objectives	4
Chapter 2. Literature review	6
2.1. The banana	6
2.1.1. Origin and history	6
2.1.2. Legend and myth	7

2.1.3. Description	9
2.1.4. Importance	12
2.1.5. Banana in Zambia	14
2.2. Banana weevil	15
2.2.1. Origin and first records	15
2.2.2. Taxonomic status	16
2.2.3. Biology and life history	19
2.2.4. Alternate hosts	21
2.2.5. Economic importance	22
2.2.6. Control strategies	23
2.3. Insect-pest resistance in plants	28
Chapter 3. Materials and Methods	32
3.1. Location	32
3.2. Banana cultivars used	32
3.3. Banana cultivar characterization	34
3.3.1. Objective	34
3.3.2. Materials and methods	34
3.4. Banana weevil orientation/arrest towards different banana plant parts	35
3.4.1. Objective	35
3.4.2. Materials and methods	35
3.5. Banana weevil orientation/arrest towards different banana cultivars (Lab. experiment)	38
3.5.1. Objective	38

3.5.2.	Materials and methods	38
3.6.	Banana weevil orientation/arrest towards different banana cultivars (field experiment)	38
3.6.1.	Objective	38
3.6.2.	Materials and methods	39
3.7.	Banana weevil movement between banana cultivars	41
3.7.1.	Objective	41
3.7.2.	Materials and methods	41
3.8.	Preference/non-preference of banana weevil for different banana cultivars	46
3.8.1.	Objective	46
3.8.2.	Materials and methods	46
3.9.	Banana rhizome nutrition status	54
3.9.1.	Objective	54
3.9.2.	Materials and methods	54
Chapter 4.	Results	58
4.1.	Banana cultivar characterization	58
4.1.1.	Vegetative characters	58
4.1.2.	Inflorescence characters	60
4.1.3.	Male flower characters	61
4.1.4.	Fruit characters	63
4.2.	Banana weevil orientation/arrest towards different banana plant parts	64

4.3.	Banana weevil orientation/arrest towards different banana cultivars (lab. experiment)	64
4.4.	Banana weevil orientation/arrest towards different banana cultivars (field experiment)	65
4.5.	Banana weevil movement between banana cultivars	66
4.6.	Preference/non-preference of banana weevil for different banana cultivars	74
4.7.	Banana rhizome nutrition status	77
Chapter 5.	Discussion, conclusion and recommendations	82
5.1.	Banana weevil orientation/arrest towards different banana plant parts	82
5.2.	Banana weevil orientation/arrest towards different banana cultivars (Lab. & field experiments)	83
5.3.	Banana weevil movement between banana cultivars	86
5.4.	Preference/non-preference of banana weevil for different banana cultivars	89
5.5.	Banana rhizome nutrition status	91
5.6.	Conclusion	92
5.7.	Recommendations	94
Chapter 6.	References	95
Appendices	103

LIST OF TABLES

No.	TITLE	PAGE
1.	Banana weevil orientation/arrest towards different banana plant parts	68
2.	Banana weevil orientation/arrest towards different banana cultivars (Laboratory experiment)	68
3.	Banana weevil orientation/arrest towards different banana cultivars (Field experiment) - Total weevil count	69
4.	Banana weevil orientation/arrest towards different banana cultivars (Field experiment) - Male weevil count	69
5.	Banana weevil orientation/arrest towards different banana cultivars (Field experiment) - Female weevil count	70
6.	Preference/non-preference of banana weevil for different banana cultivars - Feeding Indices	75
7.	Preference/non-preference of banana weevil for different banana cultivars - Preference Ratios	76
8.	Banana rhizome nutrition status	79
9.	Banana rhizome nutrition status - Correlation matrix	81

LIST OF FIGURES

No.	TITLE	PAGE
1.	Hexagonal choice chamber	37
2.	Experimental arena for orientation/arrest (Field) experiment	40
3.	Experimental arena for banana weevil movement between banana cultivars experiment	43
4.	Adult banana weevil showing the difference in curvature of last abdominal sternite between male and female	44
5.	Dorsal view of rostrum of adult banana weevil showing differences in rostrum punctuation between male and female . . .	45
6.	Weevil movement between banana cultivars - Total weevil count	71
7.	Weevil movement between banana cultivars - male weevil count	72
8.	Weevil movement between banana cultivars - female weevil count	73

LIST OF PLATES

No.	TITLE	PAGE
1.	Banana rhizome showing tunnels caused by banana weevil (larval) feeding	26
2.	Snapping of banana due to banana weevil attack	27
3.	Rhizomes placed at opposite ends of basin lined with soil	50
4.	The experimental set-up showing the basins covered with fine mosquito netting	51
5.	Pared suckers after being hot water treated before planting	57

ACKNOWLEDGEMENTS

I would like to express my gratitude to my research supervisor, Dr K. V. Seshu Reddy for his patience, invaluable advice, keen interest and immense encouragement during the course of this research project. I am also thankful to Professor A. Hassanalli and Dr I. Ndiege for their invaluable contribution in designing and implementation of the project.

I would also like to thank Dr K. J. Mbata, my university supervisor, for his guidance and encouragement. Also, Professor Siwela, Vice Chancellor University of Zambia, for his advice and interest shown in the research project.

I also thank ICIPE, especially ARPPIS, and Dr V. O. Musewe in particular, for according me the scholarship to pursue the study. The same gratitude is extended to staff and colleagues, too numerous to mention individually, based at Mbita Point Field Station, western Kenya, for their support morally and materially "*apa epashili pakuleka.*"

I also acknowledge the support from my fellow ARPPIS scholars during the time we had together both at Nairobi and Mbita Point. I acknowledge as well the contribution of my fellow workers at Mount Makulu Central Research Station, Chilanga, Zambia. Lastly, and certainly not the least, I would like to thank my wife and children, as well as my parents, for understanding and their moral support.

ABSTRACT

Banana (*Musa spp.*) is an important food crop of the humid tropical lowland areas of the world. Banana production is beset by several problems, related to crop husbandry, selection of planting material, soils, diseases, and pests. Although more than 25 borers have been recorded on banana, the banana weevil *Cosmopolites sordidus* (Germar) (*Curculionidae*) is regarded as the major contributor to the general loss in plant vigour and yield. However, some banana cultivars have been found to show resistance/tolerance to the weevil's attack. Little is known about the mechanisms that render some cultivars resistant/tolerant. In this study the relationship between the banana plant and the banana weevil were investigated with the view of incorporating the results obtained into the existing IPM programmes on the control or management of the pest. The following experiments were conducted:

1. Banana cultivar characterization.
2. Banana weevil orientation/arrest towards banana plant parts.
3. Banana weevil arrest towards different cultivars (laboratory and field).
4. Banana weevil movement between banana cultivars
5. Preference/non-preference of banana weevil for different cultivars, and
6. Banana rhizome nutrition status.

Six banana cultivars representing three genomes (AAA, AAB, and AB), and four traits (cooking sweet or desert, beer, and roasting) and adult weevils, 4-5 days old, were used in all the experiments.

The resistant cultivar, soth (AAB), attracted less weevils than susceptible cultivars nakyetengu (AAA) and gonja (AAB), and the moderately resistant cultivar sukalindizi (AB). There was a differential response among the susceptible cultivars with nakyatengu (AAA) and gonja (AAB) being more attractive than mbidde (AAA) and lusumba (AAA). There was no significant difference between the moderately resistant cultivar sukalindizi (AB) and the susceptible cultivars ($P \leq 0.05$).

Significant differences were found in the number of weevils that moved off the infested resistant cultivar soth (AAB) to the susceptible cultivars. Further, males were attracted more to banana than females and gave credence to observations that females dispersed and wonder around more than males, and that males depended on an aggregation pheromone which they produce to attract the females back to the banana for mating and /or oviposition.

The dual choice preference/non-preference experiment demonstrated that weevils used cues that are perceivable when the insect is in close contact with the banana plant. The weevils damaged (consumed) more of the susceptible cultivars than resistant check, but were indifferent when made to choose between susceptible cultivars. The method employed in this experiment could be used to evaluate large banana germplasm for banana weevil resistance/tolerance or susceptibility in breeding programmes.

There were no significant differences ($P \leq 0.05$) between the cultivars in as far as their nutritive contents were concerned. There was also no correlation between nutritive

content, rhizome weight, and weevil counts. This showed that banana weevil population built-up or colonization of a banana cultivar was not influenced by the nutritive or density status of the rhizome.

This study has shown that weevils do not depend on distant perceivable stimuli to select cultivars for colonization, but more on contact stimuli. They also do not depend on the nutritive status of the banana for them to successfully colonize a cultivar. It seems they mostly depend on secondary metabolites (especially feeding stimulants). The study has also shown that preference, antibiosis and tolerance are at play in the banana-banana weevil interaction.

CHAPTER 1

INTRODUCTION

1.1. ORIGIN AND SIGNIFICANCE OF THE BANANA CROP

The Banana (*Musa* spp.) is an important food crop of the humid tropical lowland areas of the world (Burden and Coursey, 1977). Only the coconut is more important or more widely known than the banana as food fruit. There is probably no tropical country or region today, except the Sahara desert, where some form of *Musa* is not used for human food (Barrett, 1928). It originated from the Indo-Malaysian region of the world (Greenwell, 1944; Cheeseman, 1948; Simmonds, 1966). From there, bananas were introduced to many tropical regions of the world, such as Africa, Australia, Central and Southern America, including the Caribbean, Southern U.S.A., the islands of the Indian and Pacific oceans etc (Mitchell, 1978).

In the countries of eastern Africa (Burundi, Ethiopia, Kenya, Rwanda, Tanzania, Uganda, and Zaire), banana is an important staple food crop. Its production and utilization vary according to ecological and socioeconomic conditions of the given localities. In the region, banana is a smallholder crop which is used both in rural and urban areas. It not only provides carbohydrates and vitamins for the population but is also an important source of cash income (Ddungu, 1987).

Several factors influence the yields of banana. These include crop husbandry, selection of planting material, soils, pests and diseases. Although more than 25 insect borers have been recorded on banana (Seshu Reddy et al, 1994), (see Appendix 1), essentially, the banana weevil, *Cosmopolites sordidus* (Germar), is regarded as a major contributor to the loss in general plant vigour and yield (Moznette 1920; Froggatt 1925; Barrett 1928; Vilardebo 1973; McNutt 1974; De Langhe 1986; INIBAP 1987; Nsemwa 1991; Uronu 1992; Seshu Reddy and Lubega 1993; Seshu Reddy et al 1994; Rodomiro et al 1995). Some banana cultivars however, have been found to be less attacked than others by the weevil (Masefield 1944; Sen and Prasad 1952; Viswanath 1981; Ittyepe 1986; Seshu Reddy and Lubega 1993; Rodomiro et al 1995). The above authors have identified cultivars showing resistance, but the mechanisms of such resistance have not been elucidated.

1.2. STATEMENT OF THE PROBLEM

Some banana cultivars have been reported to show resistance/ tolerance to the banana weevil. Wolcott (1930) reported that peasants in Haiti, in the Caribbean, had learnt through experience that some varieties of plantain and banana were more infested by the weevil than others and that some normally exhibited vigorous growth allowing them to produce fruit despite the weevil's presence. While working in Uganda, Masefield (1944) noted that the Baganda people recognized some banana cultivars that were resistant to

the weevil from those that were not. Cultivars like *namwezi* and *nakabululu* were reported to be resistant while *nsowe* was said to be particularly susceptible. Using the split pseudostem baits, Haddad and colleagues (quoted by Mesquita et al, 1984) found that cultivars of the AAB and ABB banana groups had a higher coefficient of infestation and larger numbers of adult weevils.

Other workers including Sen and Prasad (1952), Viswanath (1981), Mesquita et al (1984), Uronu (1992), confirmed the existence of resistant and susceptible cultivars to the banana weevil.

In their study on banana semiochemicals, Ndiege et al (1990, 1991a) showed that there was positive weevil attraction to volatiles extracted from pseudostems and rhizomes of different banana cultivars. It was reported however that the weevils showed no preference for volatiles extracted from resistant or susceptible cultivars. This could be indicative that semiochemicals do not play a major role in the colonization of banana plants by adult weevils, but possibly that they are important during the oviposition and/or feeding stages of the insect which are responsible for most of the damage to the plant.

Little is known about the mechanisms that render some banana cultivars susceptible and others not susceptible to the banana weevil. This study aimed at bridging the gap in our understanding of the banana plant and the banana weevil with the view of incorporating

the results obtained into existing integrated pest management (IPM) programmes for the banana weevil.

1.3. OBJECTIVES OF THE STUDY

1.3.1. BROAD OBJECTIVE

The broad objective of the study was to, investigate factors that influence the infestation and colonization of the banana plant by the banana weevil, *Cosmopolites sordidus* (Germar).

1.3.2. SPECIFIC OBJECTIVES

The specific objectives were to:

- 1.3.2.1 supplement the classification information on the cultivars that were being used in the study;
- 1.3.2.2. determine which parts of the banana plant the weevil preferred most;
- 1.3.2.3. study the orientation/arrest of the banana weevil towards/on different banana cultivars as an indicator of preference or non-preference of the weevil for the various cultivars;

- 1.3.2.4. evaluate adult weevil movement off infested cultivars as a measure of non-preference;
- 1.3.2.5. investigate whether non-preference was the mechanism of resistance at play between the banana and the banana weevil; and
- 1.3.2.6. determine whether there was any correlation between rhizome nutritional status, age of rhizome, weight of rhizome and banana weevil population build-up.

CHAPTER 2

LITERATURE REVIEW

2.1. THE BANANA

2.1.1. ORIGIN AND HISTORY

Banana originated from the Indo-Malaysian region and probably began its westward journey 3,500 years ago. Alexander the Great's army found bananas in the Indus Valley in 327 B.C. growing with cotton and mangoes in vast fields (Barrett, 1928). In 1516, the Spanish Friar, Tomas de Berlanga, found the semi-civilized inhabitants of the Canary Islands depending on banana instead of barley as they had done a few generations before. Seeing the banana's potential value for the colonialists in the Antilles, he carried a few suckers that year over to Hispaniola, and it is probably from these suckers that plants were well distributed throughout the West Indies before 1550 (Barrett, 1928).

The theories on the arrival of banana or plantain (its close relative) in the Canaries are somewhat improbable. The bananas in the Canaries must have come from India, perhaps via Arabia, either across Africa or around the Cape. It is questionable whether African tribes passed them on from one to another over 4,000 miles of very precarious travelling, or whether the Phoenicians or probably the Portuguese somehow managed to get them down the east coast and up the west, presumably after Vasco da Gama's eleven

months trip in 1497 (Barrett, 1928).

Against this fairly plausible explanation is the fact that the learned Portuguese pharmacist, Garcia da Orta, made a voyage around the Cape in 1536. He reported several similar names which the natives of the Guinea Coast applied to these fruits *banana, bonano, banema*. He found the same sort of fruits being cultivated, when he went ashore at Sofala in the northern part of Mozambique. Here the fruits were known as *bananos* (Barrett, 1928).

Greenwell (1944) reported that banana was in Mombasa, Kenya, in 1300 A.D., and in Lamu, Kenya, around the 15th century. The Hovas of Madagascar introduced the crop to the rest of east Africa before 1543 A.D. The Arabs are said to have been responsible for introducing bananas into Egypt from India during the fifteenth century.

2.1.2. LEGEND AND MYTH

The following narration is quoted from Neal (1965), unless otherwise stated:

In parts of Eurasia early names of the banana were "fruit of paradise" and "fruit of knowledge." It was believed that the banana plant was the source of good and evil and that the serpent was hiding in a bunch of bananas before he (serpent) tempted Eve in the garden of Eden.

8

In Sumatra, it is said that a god who was sent to earth to finish creation should have fasted or eaten crab; but he ate bananas and therefore man's life is short like that of the banana instead of renewing like that of the crab, which every year has a new shell.

In Hawaii, it was believed to be bad luck to dream of bananas or to meet a person carrying them, and to carry bananas as part of a lunch on a fishing trip is said to bring bad luck.

In sacrifices to the gods, a banana stalk was sometimes used as a substitute for a human sacrifice.

A Hawaiian belief that lingers on to this day, is that, to dream of a hole in the ground is the sign of an open grave and that to offset bad luck the dreamer ought to bury a whole young banana plant, or the trunk of a banana.

Legend says that all bananas held their fruits erect until the lowland bananas were defeated in a battle with the mountain bananas. Ever since then, the lowland bananas have hung their heads in shame.

De Langhe (1986) reported that in east Africa, with the exception of Zanzibar, a young man interested in taking a girl for a wife would not be introduced to her parents without a calabash of banana beer. In fact, a crate of European beer was unacceptable for the

purpose. He went on to report that disputes and quarrels were usually settled over a pot of banana beer to ensure a true spirit of reconciliation. Banana was, and still is, offered as a gift prior to requests for favours from chiefs and influential people.

2.1.3. DESCRIPTION

Bananas, plantains and the Manila hemp plant are monocotyledonous plants belonging to the section *Eumusa* of the genus *Musa* in the plant family *Musaceae* (Neal, 1965; Simmonds, 1966; Wardlaw, 1972). The genus *Musa* has about 30 to 50 species worldwide (Barrett, 1928; Simmonds, 1967). The genus name is in honour of Antonio Musa, a physician to Roman Emperor Augustus (Barrett, 1928).

Banana is a large, herbaceous perennial and aside from the bamboo, is the tallest and the largest woodless plant (Barrett, 1928; Wardlaw, 1972). It consists of a branched underground stem or rhizome, with abundant roots, and erect leafy 'trunks' or 'plants' which eventually bear bunches of banana. A bunch is made up of a cluster of bananas. Each cluster is referred to as a 'hand' while each individual banana a 'finger'. As each bunch is harvested, the mother plant bearing that bunch is also cut and a preselected sucker (daughter) continues to grow from the same base (mat or stool). When the daughter's fruit is harvested, another sucker (grand daughter) is left to grow in its place (Ostmark, 1974).

The nowadays known bananas and plantains resulted from human selection (not breeding) of varieties from *Musa acuminata* (AA genome) and hybrids between this wild banana and *Musa balbisiana* (BB genome), another wild species of the family Musaceae (Simmonds, 1966; Karikari, 1973; Simmonds and Weatherup, 1990; Commandeur, 1994).

The nomenclature of banana and plantain is extremely confusing, since the same name is sometimes used for different varieties and vice versa. The dividing line between bananas and plantains does not coincide with those of fruits that can be eaten fresh, or those that need to be cooked. Plantains are simply a sub-group of AAB genome of bananas (Wardlaw, 1972; Commandeur, 1994). The triploid cultivars are AAA, AAB, or ABB and the edible diploid are AA and AB. All these banana genotypes exist in east Africa (Simmonds, 1966; Burden and Coursey, 1977; De Langhe, 1986). There is no critical evidence in favour of the view that there exists pure *balbisiana* cultivars (BB, BBB) (Simmonds and Weatherup, 1990).

Simmonds (1986) classified edible bananas into three triploid groups:

1. AAA Cavendish group;

These have low starch and high sugar content when ripe. They are sometimes used for cooking when green.

2. AAA Cooking group;

These remain starchy even when ripe and are edible only after cooking. There are two natural groups of this type of banana: 1. French plantain; which bears 7-10 or more hands and numerous fingers to each hand and having a persistent male axis. 2. Horn plantain; with 3-5 hands with a few fingers per hand and a deciduous male axis.

3. ABB called BLUGGOES in the Caribbean;

They are very starchy and well adapted for drier and exposed situations (Simmonds, 1966).

In the highlands of eastern Africa, there exists a large group of banana cultivars that have no counterparts in any other region of the world. They are well adapted to altitudes ranging between 1000 to 2000 metres above sea level. The highland banana, as they are known, needs a minimum of 800 mm of precipitation per year, if rainfall is evenly distributed throughout the year, or 1500 mm if the dry season is pronounced with exception of the river banks (De Langhe, 1986).

Banana cultivars are also grouped according to the way they are used, i.e. brewing, cooking, dessert, and roasting. Although the groups overlap, it appears that no relation exists between the genomic constitution and the culinary destination of the product (De

Langhe, 1986).

2.1.4. IMPORTANCE

The importance of banana is varied within the different producing areas of the tropics. World production of banana and plantain was estimated at 78 million tons by FAO in 1992, of which 27 million were produced in Africa. Eighteen million tons were produced in South America, 9 million in Central America and the Caribbean (FAO, 1993) (see Appendices 2 and 3). It is however very clear that it forms an important food crop for millions of subsistence farmers worldwide. The year-round fruiting habit of the crop makes it valuable for both food and income generating purposes.

Approximately 20 million people in east Africa depend on banana and related species as the principal source of dietary carbohydrates and vitamins (INIBAP, 1986). This is eaten uncooked in the ripe state or cooked (or roasted) in the raw state or used in brewing local beverages (Simmonds, 1966). Banana has become a very important staple in the marginal segments of societies in much of the developing world as well as in the industrialized countries from the temperate West (Rajamony *et al*, 1993). "Now Magazine" of 3rd February, 1991, reported that 300 bananas had been delivered for tennis players the previous August at Wimbledon. The reason for the banana's popularity is a high natural sugar content, plus complex sugars which give a delayed release of energy over a long period; very useful for people who need to keep going like

tennis players.

As an income generating commodity it accounts for about 70% of the Windward Islands (Grenada, St. Vincent, St. Lucia and Dominica) export earnings (Ambrose, 1984). It may account for only 3% of Jamaica's export earnings, but it is an important means of employment and livelihood of the population (Ambrose, 1984). In Africa, the crop constitutes half the total annual production of approximately 9 million tons of fruits (Seshu Reddy *et al.*, 1994). Tang and Hwang (1994) reported that Taiwan produced about 100,000 tons of banana annually of which 66,000 tons were exported to Japan and Korea.

The importance of banana can also be looked at in terms of the crops contribution to reducing soil erosion on steep slopes of highland areas; as the principal source of mulch for maintaining and improving long term soil fertility; provision of shade to cocoa and coffee plantations (Cardenosa-Barriga, 1961); as a windbreak to vegetable gardens (Stover and Simmonds, 1987); and it has a nutritional as well as a social role, e.g. leaves are used for thatching, and craftsmen produce some decorations, fibre, and wrappers. Also vinegar is produced from the fruits (Simmonds, 1986).

It should be emphasized that the bulk of the banana produced worldwide is more important as a food crop for local consumption by the small scale farmers who grow or sell it in the local markets (INIBAP, 1987); only 10 per cent of the global production is exported (Commandeur, 1994).

2.1.5. BANANA IN ZAMBIA

Bananas are widely grown in Zambia, with Luapula Province being the main producer. The variety widely grown is dwarf cavendish although some plantains are also grown in isolated areas (Anon, 1964).

It is not known exactly when bananas were introduced in Luapula Province, but the misnomer *malindi* banana suggests that the crop may have come from Malindi in Kenya (Anon *Ibid.*). It was estimated that by 1953, 500 peasant farmers, were engaged in banana production in the province. Approximately 60 hectares of land was devoted to the crop, the largest plantation controlled by one farmer was about 1.2 hectares. A further 48 hectares of land was put to banana cultivation by commercial farmers (mostly Europeans) along the line of rail (Anon, *Ibid.*).

Before 1962, most of the banana produced was marketed to Zaire across the Luapula River. Due to political instability, access to the Zaire market was lost and this led to a decline in banana production. The FAO (1990) estimated that Zambia produced approximately one metric ton of banana between 1988 and 1989. In recent years the government has made efforts to encourage banana production by establishing a banana plantation in Luapula Province (late 1960's) as well as others along side sugar plantations in the Southern Province (Dr Munyinda, per. com.) in its effort to improve food

production.

However, efforts to encourage a resumption in production of the crop by the government has been hampered by a lack of adequate extension service, poor site selection for new plantations, diseases and pests especially cigar-end rot and banana weevil, and lastly but not least, handling of the produce consigned from the province to other areas of the country (Anon, *Ibid.*).

2.2. THE BANANA WEEVIL *Cosmopolites sordidus* (Germar)

The banana weevil or banana borer weevil, *Cosmopolites sordidus* (Germar) belongs to the family Curculionidae and Super family Curculioniodea in the Order Coleoptera. Members of the family Curculionidae (snout beetles) are characterized among other things, by a well defined beak (rostrum) which is long and curved downwards; geniculate 3-6 segmented antennae; trochanters that are usually long; the ventral surface of the mentum with long projecting setae; larval frontal sutures which are not reaching articulating membrane of mandible.

2.2.1. ORIGIN AND FIRST RECORDS

The banana weevil is native in the Indo-malaysian region of the world (INIBAP, 1986; Stover and Simmonds, 1987). It has been spread widely, through planting material, in

both the eastern and western hemispheres. It is now found in most countries where bananas are grown as a crop (Zimmerman, 1968a).

According to Harris (1947), the banana weevil was first mentioned in connection with banana by Fletraux and Salle in 1889 in their account of beetles of Guadeloupe, as being common in rotting banana. However, it was only regarded as a pest of banana in 1906 when an account of its destructive powers was given at the Island of Sao Tome, in the Gulf of Guinea. It appears to have been observed as a pest at about the same time in localities as far apart as Madagascar and Fiji. Fleutiaux (quoted in Moznette, 1920) reported the insect as a serious pest of banana in Madagascar in 1903. In Lesser Antilles, it was reported to be causing severe damage to banana in 1912 by Ballou (quoted in Moznette, 1920). The same worker (Moznette, 1920) reported that the weevil was recorded by Fletcher in 1914 in southern India. Likewise the insect was recorded in Uganda by Masefield in 1944.

2.2.2. TAXONOMIC STATUS

Harris, in his report of 1947 said that the banana weevil was first described by Germar in 1824 as *Calendra sordida*, but that in 1845 Fabricius independently described the same weevil as *Sphenophorous striatus*. The same report added that the *Cosmopolites sordidus* was coined by Chevrolant in 1885.

The following description is based on the work of Moznette (1920) and Zimmerman (1968a) as well as personal observations unless otherwise stated:

ADULT (see Fig. 4):

Black or very dark brown in colour about 12 mm long; head is small and spherical; beak is separated from the head by a constriction, it is swollen in the basal one third, finely punctate in basal half, moderately curved, slender and cylindrical and smooth in apical half. Antennae geniculate, scape almost as long as funicle. Funicle 6-jointed, first joint moniliform, succeeding joints more closely appressed, last joint very closely appressed to club. Club 2-jointed, basal joint occupying two thirds of the length, shining, with a few minute hairs; apical joint spongy, short, and rounded at apex. Other funicular joints bearing a few tiny hairs. Eyes finely granulate, elongate oval, transversely contiguous beneath, anteriorly margined. Prothorax very long; moderately evenly punctate. Scutellum small, subquadrate, moderately short, with slight humeral angles. Pygidium almost vertical, spongy, pubescent, with setigerous punctures. Sternum flattened. Procoxae and mesocoxae cylindrical, metacoxae oval, trochanters small, femora laterally compressed and curved, ventrally inflated at middle, emarginate beyond this and bilobed at apex, thus forming a groove for the tibia. Tibia moderately straight, grooved beneath and provided with a row of setae on each side of the groove, apically curved downwards, terminating in a strong hook. Tarsi 4-jointed. First two abdominal segments connate at middle. Third and fourth segments

about as long as second. Fifth segment longer, turned downwards.

LARVA:

The larva is smooth, fleshy, legless and white in colour. It carries a conspicuously red to brown head capsule bearing sharp mandibles. It is characteristically vermiform, having the eighth and ninth segments transformed into a sort of pygidial plate bearing very large elongated spiracles on the eighth segment. The other abdominal spiracles are all very minute and indistinct. The mesothoracic spiracles are very large. The body is white and the head shield dark reddish brown in colour. The body is glabrous except for the usual hairs found on each segment. The head is quite prominent. The antenna is fleshy 2-jointed appendage located at the lateral angle of the frons.

PUPA:

Elongate, about 12 mm long, white in colour. The pupae is characteristic calandrid in the possession of very large thoracic spiracles located on a prominent lobe at the base of the prothorax.

2.2.3. BIOLOGY AND LIFE HISTORY

The biology and life history of the banana weevil has been studied by many workers including Froggatt (1925, 1926, 1928); Pinto (1928); Harris, (1947); Zimmerman (1968b); Feakin (1971); Foreman (1973); Uzakah, 1991; Afreh-Nuamah (1993); Bakyalire and Ogenga-Latigo (1993); and Uronu (1992).

The banana weevil *C. sordidus*, a holometabolous insect, has four distinct developmental stages; egg, larva, pupa, and adult. All the four stages are found throughout the year.

EGG:

The eggs are oval shaped and measure between 1.5-2.0 mm long. These eggs are laid by the female weevils in between the leafsheath of the pseudostem (Zimmerman, 1968b). The female usually lays these eggs on injured areas or on non vigorously growing or ends of cut stems. The female prepares cavities about 1-2 mm deep near the base of the pseudostem (where it joins the rhizome) with its powerful mandibles for laying the eggs. Two or four eggs are laid per cavity (Uronu, 1992).

LARVA:

The larvae hatch 5-8 days after oviposition (Froggatt, 1928; Uronu, 1992; Bakyalire and Ogenga-Latigo, 1993) and start to bore into the rhizome towards the

centre. Sometimes the larvae bore up the pseudostem up to as high as 1.5 m above the ground level. The tunnels (damage) made by the larvae become longer and wider as the larvae grows (Treverrow et al, 1992). After about 14-21 days the larvae pupates close to the surface of the rhizome (Frogatt, 1925, 1926).

PUPA:

The pupa is exarate. The pupal stage lasts about 8 days during which time the colour darkens slightly as the insect beneath its outer skin changes into adult form and takes on brown colouring (Pinto, 1928; Harris, 1947).

ADULT:

The adult weevil emerges from the thin pupal skin which is quite soft and brown in colour. It remains motionless in the tunnel for 2-3 days giving its integument chance to harden and take on a darker black colour (Uronu, 1992). It then finds its way to the surface and takes shelter in the ground debri or under moist habitat near the base of the plant during the day. The beetle is slow moving and when removed from the plant it feigns death, but will resume movement after a short while. The adult weevil does not fly (Simmonds, 1928). The adult does little damage compared to the larvae. The adult weevil shuns light and is most active during the night (Anon, 1969). Zimmerman (1968b) observed that the adults, before emerging, congregate in the cavities tunnelled by the larvae at the base of the rhizome.

It takes about 30-50 days (at 28°C and 68% RH) from one generation to the next. The weevil can live for up to 2 years in which time the female can lay up to 100 eggs after only one mating (Treverrow et al., 1992), which may happen six days after emergence; the earliest time insemination is known to occur (Uzakah, 1991). For an insect laying so few eggs (K-strategy) it is comparatively successful (Hill, 1983; Uronu, 1992) and it could partly explain the observation that damage by the weevil is evident after 5-7 years.

2.2.4. ALTERNATE HOSTS

From published information, it appears that the banana weevil has a very limited host range. The weevil is specific to plant species that belong to the banana genus *Musa* (Moznette, 1920). Besides banana, sugar cane, manila hemp, and yam have been reported as hosts (Anon, 1968). Also, *Ricinodendron hendeloti*, *Panicum maximum*, *Xanthomonas sagittifolium*, and *Dioscorea batatas* have been recorded (Beccari, 1967). However Martinez et al. (1990) observed that the banana weevil attacked *Xanthomonas sagittifolium* and *Xanthosoma violaceum*, but did not lay eggs on these hosts.

2.2.5. ECONOMIC IMPORTANCE

The Banana weevil is undoubtedly one of the major constraints to banana production in the banana producing areas of the tropics and sub-tropical regions (Moznette, 1920; Froggatt, 1925; Anon, 1968; Franzman, 1972; Vilardebo, 1973; McNutt, 1974; INIBAP, 1986, 1987; Stover and Simmonds, 1987; Koppenhofer et al, 1991; Pavis and Minost, 1993; Seshu Reddy and Lubega, 1993; Rodomiro et al, 1995).

It is believed that this pest may have been introduced into Africa from the Indo-Malayan region (INIBAP, 1986; Stover and Simmonds 1987). The pest may have been introduced through planting material, and it has since spread to all the banana growing areas of the continent (INIBAP, 1986). The weevil causes two types of damage to the banana:

1. Direct damage (physical)

Damage is caused by the larvae which feed and make tunnels in the rhizome and sometimes the whole length of the pseudostem, resulting in snapping, leaning, stunting and reduced fruit size (Seshu Reddy, 1987)(Plates 1 and 2).

2. Indirect damage

This is due to infection by bacteria and fungi following physical damage caused by larvae of the weevil. The physical damage predisposes the plant

to microbial attack which also result in reduced bunches or yield in general.

Though the banana weevil has been recognized as a serious pest of banana, information on extent of yield losses based on experiments is lacking. It is reported that Brazil has about 30% yield loss and Equador 20-40% (Liceras et al, 1973), while Roberts (1955) reported 25-85% yield loss in Honduras.

2.2.6. CONTROL STRATEGIES

A number of control strategies are applied in the control of the banana weevil in banana plantations. These include: trapping; chemical; cultural; biological; botanical and use of semiochemical as well as host plant resistance (Treverrow et al, 1992; Seshu Reddy et al, 1994).

Different types of insecticides including chlorinated hydrocarbons and organophosphates have been tried in the control of the banana weevil, but these have been found to be hazardous to the user and the environment. The insecticides also lead to general deterioration in crop hygiene, and enhance development of insecticide resistance in the weevil population. The insecticides are too expensive for small scale farmers, who grow the crop in Africa (Braithwaite, 1967; Mitchell, 1978; Stover and Simmonds, 1987).

Trapping the weevils using split pseudostems or rhizome pieces placed at the foot of the plants, and then destroying the trapped weevil mechanically or by chemical means has been recommended for use since the beginning of modern commercial production of banana (Wallace, 1938; Yaringano and Meer, 1975). However, the method is rather impractical due to the labour costs involved in its application (Stover and Simmonds, 1987).

Several cultural methods are recommended for the control of the weevil. These include, the use of weevil free planting material; paring (removal of thin layer of outer skin of rhizome) followed by hot water treatment of planting material; destruction of volunteer crops as well as deep ploughing if the old field has to be replanted; and the banana plantation should be kept weed free (Wallace 1938; Lara, 1966; McNutt, 1974; Ostmark, 1974; Pinese, 1989; Seshu Reddy et al., 1994).

Biological control of the banana weevil was suggested as a potential means by which the weevil could be controlled (Neuenschwander, 1988). Koppenhofer et al., (1991) and Beccari (1967) identified 12 and 13 predators, respectively of the weevil. Among the predators Koppenhofer et al., identified, *Dactylosternum abdominale* Fabricius and *Thyrecephalus interocularis* Eppelsheim (Coleoptera) were shown to reduce weevil multiplication by 40-90% and 42% respectively in the laboratory.

Botanical pesticides such as those derived from *Tephrosia* spp. have been found to have

a repellency effect on the banana weevil (Walangululu et al., 1993).

Host-plant resistance is certainly one method that could offer a safe and long-term beneficial component of integrated pest management (IPM) to the control of the banana weevil for small scale farmers (Seshu Reddy and Lubega, 1993; Rodomiro et al., 1995).

The developmental period of the weevil was increased by 7 days when fed on *Figo vermelho* (AAB) when compared to *Nancia* (AAA). The latter resulted in a higher larval death rate and lower pupal cases (Mesquita et al., 1984).



PLATE 2.

Snapping of banana plants due to banana weevil attack



PLATE 1. Banana rhizome showing tunnels caused by banana weevil larval feeding

2.3. INSECT-PEST RESISTANCE IN PLANTS

Plant resistance to insect pests has been reported as far back as 1785 but it was not until Painter in 1951 wrote the first book on insect resistance in crop plants that the subject was brought into sharp focus (Singh, 1986).

Painter (1951) defined resistance as "The relative amount of heritable qualities possessed by the plant which influence the ultimate degree of damage done by the insect". Painter emphasizes resistance in agricultural terms in this definition by stressing on the economic damage caused by the insect and the agronomic attributes of the crop plants. He classified varietal resistance into three categories:

1. Non-preference:

when a plant possess characteristics that make it unattractive to insect pest for oviposition, feeding, or shelter.

2. Antibiosis:

when the host plant adversely affects the bionomics of the insect feeding on it.

3. Tolerance:

when the damage to the host plant is only slight despite its supporting an

insect population size sufficient to damage a susceptible host.

A definition of resistance that takes into account biological relationships was suggested by Beck (1965), as "collective heritable characteristics by which a plant species, race, or individual may reduce the probability of successful utilization of the plant as a host by an insect race, biotype, or individual."

In this definition tolerance is not regarded as a form of resistance. Beck (1965) argued that despite being an important plant characteristic, tolerance implied a biological relationship between insect and plant that does not inhibit insect population and that could sometimes encourage population build up.

Arguing on the same biological point, Kogan and Ortman (1978), proposed the use of the term **antixenosis** to replace non-preference as the latter term did not have the conciseness of antibiosis. Resistance describes the reaction of the plants to insect attack, whereas non-preference describes the insect's response to the plant. In this study, the term non-preference was used, as it is the insect reaction that was evaluated to determine which mechanisms of resistance were being employed by the banana against the banana weevil.

Beck's definition of resistance was amplified by Saxena (1969, 1984); and Saxena *et al.*, (1974). Resistance was considered to be the result of a series of interactions between

plants and insects which influences the ultimate degree of establishment of insect population on plants.

The factors that determine insect establishment on a plant can be categorized into two main groups:

1. Response of an insect to plants;

These are insect behavioural and physiological responses considered during insect establishment on a plant.

They include:

(A). Orientation:

Involving the attraction or repulsion and resulting in arrival or avoidance of different plants.

(B). Feeding:

Involving stimulation or inhibition of food intake by different plants.

(C). Metabolism of ingested food:

Involving its utilization by the insect and determining its nutrition.

(D). Insect development:

If in the larval stage.

(E). Egg production:

If adult.

(F). Oviposition:

Which may be stimulated or inhibited by different plants.

- (G). Egg hatchability.
2. Characteristics of the plant which may influence these responses include:
- (A). Distance perceivable stimuli; including visual, olfactory, or hygro dependent stimuli.
 - (B). Contact perceivable stimuli; which may be morphological or biochemical.

Morphological, biophysical and anatomical components of the plant interfere with insect's vision, orientation, locomotion, feeding, mating or oviposition mechanisms, e.g. pubescence is often regarded as an ovipositional barrier (Schillinger and Gallun, 1968). The biochemical factors on the other hand include nutritional and non-nutritional chemicals. The interruption of one or more of these behavioural and physiological responses of the insect by the biochemical and/or morphological components of the plant in the insect-plant interaction, renders the plant resistant (Saxena, 1969).

CHAPTER 3

MATERIALS AND METHODS

3.1. LOCATION

The experiments were conducted at the ICIPE's Mbita Point Field Station (MPFS), 500 km west of Nairobi, Kenya, on the shores of Lake Victoria. Mbita Point lies between latitudes 0° 25' and 0° 30' south; longitudes 34° 10' and 34° 15' east, with an altitude of 1240 metres above sea level. The mean annual rainfall is approximately 900 mm with temperatures ranging between 19° and 33°C.

3.2. BANANA CULTIVARS USED

Six banana cultivars were used in this study. The selection of the cultivars was based on the work by Seshu Reddy and Lubega (1993).

The cultivars were:

CULTIVAR	GENOME	TRAIT/USE	STATUS
1. Soth	AAB	sweet	resistant
2. Sukalindizi	AB	sweet	moderately resistant
3. Nakyetengu	AAA	cooking	susceptible
4. Lusumba	AAA	cooking	susceptible
5. Gonja	AAB	roasting	susceptible

6. Mbidde AAA beer susceptible

This represented three genomes (AAA, AAB, and AB), and four traits or uses (cooking, sweet or dessert, beer and roasting).

The rhizomes and pseudostems for the experiments were obtained from the existing germplasm maintained by the Banana Project at ICIPE's Ungoye Field Site (UFS), and the rhizome characterization experimental plot also at UFS 35 km west of MPFS.

A banana weevil colony was established from weevils collected from another colony that was being maintained by the Banana IPM Project. The weevils were maintained on a diet of pseudostems and rhizomes from cultivars sukalindizi and mbidde as there was no artificial diet to rear them. Two cultivars were used to prevent insect conditioning to one cultivar. These were kept in 40 litre capacity plastic containers whose top was covered with fine mosquito netting. The containers were kept outside along the verandah of the laboratory.

3.3. BANANA CULTIVAR CHARACTERIZATION

3.3.1. OBJECTIVE

This exercise was undertaken to supplement the classification information on the cultivars that were being used in the study.

3.3.2. MATERIALS AND METHODS

Five (5) plants were randomly selected using random numbers from each of the cultivars that were growing in the rhizome characterization experimental plot (section 3.9) at Ungoye Field Site (UFS). The plants were 20 months old after planting. The method of characterization was adopted from IITA's Training Manual on banana (1994). Details of characterization features are shown in Appendix 4 (Page 110).

The characters recorded were:

1. Vegetative
2. Inflorescence
3. Male inflorescence
4. Fruit

Frequency distribution analysis was used to analyze the data.

3.4. BANANA WEEVIL ORIENTATION TOWARDS DIFFERENT BANANA PLANT PARTS

3.4.1. OBJECTIVE

The objective of this experiment was to determine parts of the banana plant that the weevil preferred most, and consequently use such parts for subsequent experiments.

3.4.2. MATERIALS AND METHOD

A hexagonal choice chamber, made of clear perspex, 25 cm in width and 21 cm in height was designed and used. A 7.5 cm hexagonal central tube divided the 6 choice compartments of the chamber from each other. At the base of the tube was a 1 cm opening linking the choice chamber to the central tube. A 2 cm opening was left in the centre of the top cover for ventilation (Fig 1).

The banana plant parts (treatments) used in this experiment were:

1. Pseudostem
2. Pseudostem/rhizome junction
3. Rhizome.

Pieces of banana tissue 5 x 5 x 5 cm (two for each treatment) obtained from each treatment were randomly placed in each of the six chambers.

One hundred weevils (50 ♂, 50 ♀) were introduced through the opening in the top cover. The experimental design used was complete randomized design (CRD) with 6 replications. The experiment was conducted in a dark room.

The data collected included numbers of weevils found on each treatment 24 hours after release of the insects. Mean separation was based on LSD test after ANOVA.

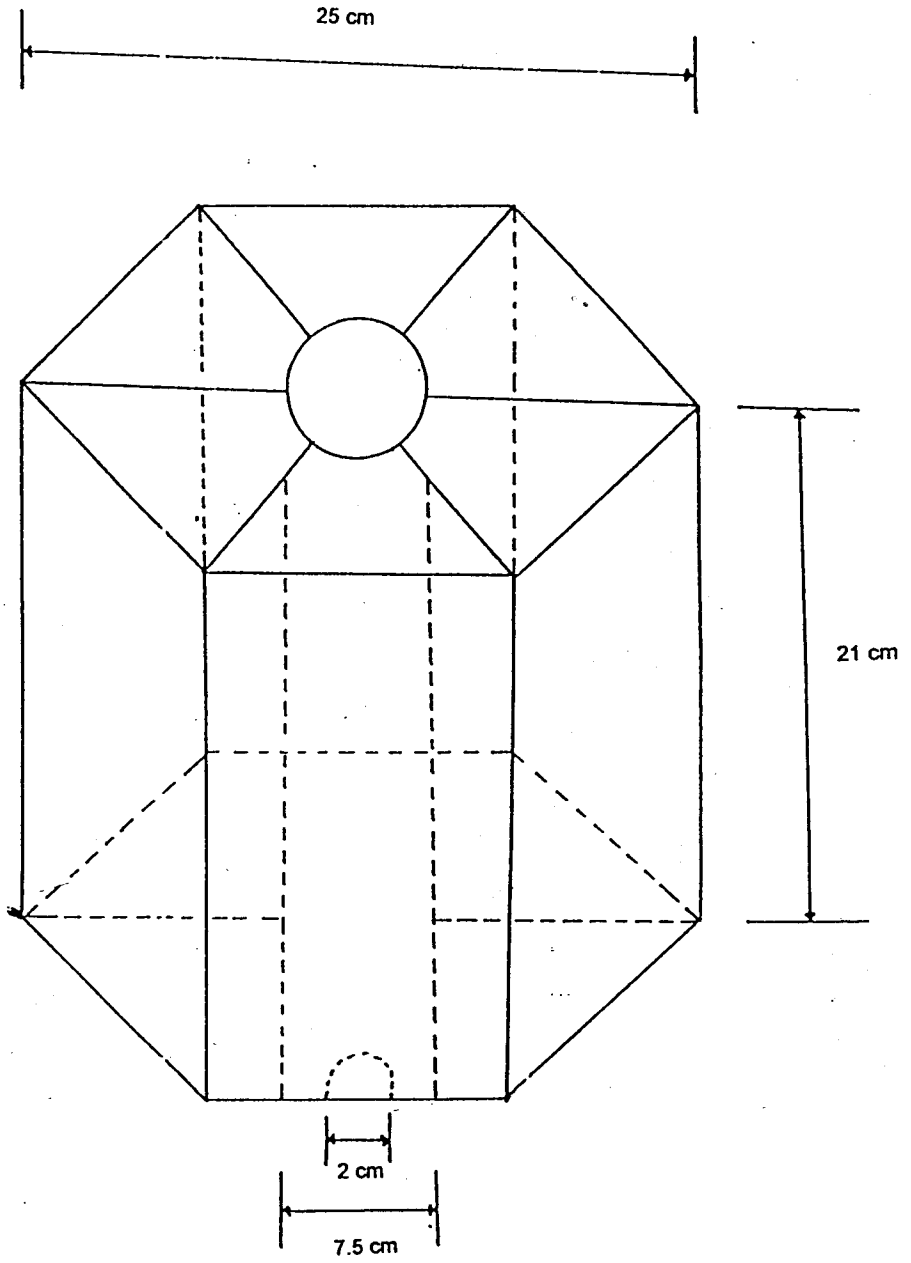

FIG. 1. Hexagonal choice chamber

3.5. BANANA WEEVIL ORIENTATION/ARREST TOWARDS DIFFERENT BANANA CULTIVARS (LAB. EXPERIMENT)

3.5.1. OBJECTIVE

To study the orientation/arrest of the banana weevil towards/on different banana cultivars as an indicator of preference or non-preference of the weevil for the various cultivars.

3.5.2. MATERIALS AND METHODS

The materials and methods, as well as the experimental design and statistical analysis, used in this experiment are the same as those used in experiment 3.4.2 above. The cultivars (treatments) used were gonja, lusumba, nakyatengu, mbidde, soth and sukalindizi. Mean separation was based on LSD test after ANOVA.

3.6. BANANA WEEVIL ORIENTATION/ARREST TOWARDS DIFFERENT BANANA CULTIVARS (FIELD EXPERIMENT)

3.6.1. OBJECTIVE

The objective of this study was the same as that of 3.5.1. except that this experiment was conducted in the field and over a wider area.

3.6.2. MATERIALS AND METHODS

An experimental arena 10m x 10m was prepared by removing all vegetation and levelling the ground. Around the perimeter of the arena was mounted a wind break of fine wire netting to reduce the wind speed over the experimental area (Fig. 2).

Due to lack of plants of the same age, only four of the six cultivars were used, viz; lusumba, mbidde, nakyetengu, and sukalindizi. Split pseudostems from each cultivar (treatment) were used in the experiment.

In a circle, 2 m from the centre the various treatments were randomly placed at equal distance from each other. Weevils (N=100; 50 ♂ and 50 ♀) (The sexing procedure used is described in section 3.7.2 below), were released at the centre, usually at sunset.

The experimental design used was the Randomized Complete Block Design (RCBD) with four replications. Data (number of weevils found on each treatment) was recorded 24 hours after release of the weevils. Mean separation was based on Tukey's Studentized Range test after ANOVA.

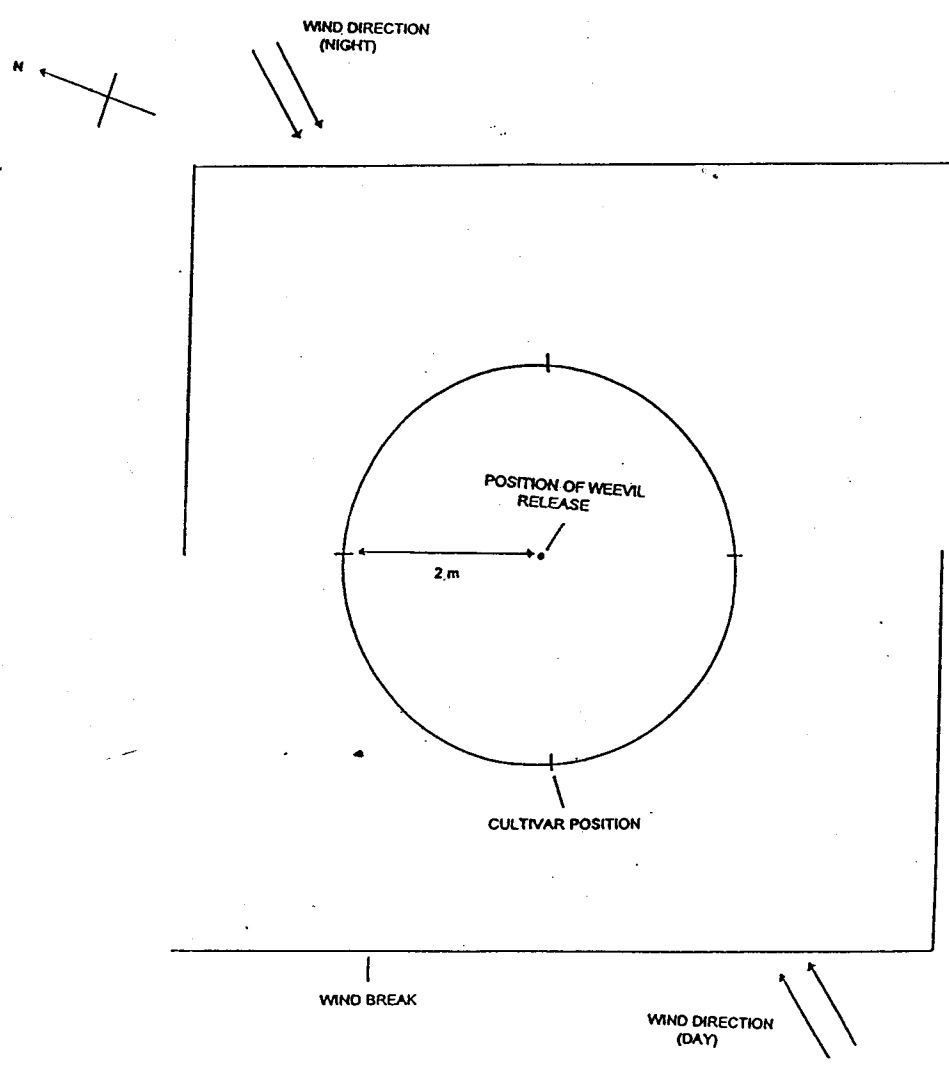

Fig. 2. Experimental arena for orientation (field) experiment

3.7. BANANA WEEVIL MOVEMENT BETWEEN BANANA CULTIVARS

3.7.1. OBJECTIVE

The objective of this experiment was to evaluate adult weevil movement off infested cultivars as a measure of non-preference of the various banana cultivars.

3.7.2. MATERIALS AND METHODS

The experiment was conducted at MPFS in the field. Split pseudostems, 20 cm in length, collected from plants 16 months after planting, were used in this experiment.

An experimental arena similar to that described in section 3.6.2. was used.

The cultivar, soth, was placed in the middle of the arena. Eight (8) split pseudostems of each test cultivar (either lusumba, sukalindizi, mbidde, gonja, or nakyetengu) were placed at equal distance from each other in circles two circles of radius 2m and 4m respectively (Fig. 3). Four pseudostems were used in each circle.

One hundred (100) insects (50 ♂ and 50 ♀) that were four to five days old, were sexed in the laboratory. Two features of the weevil were used to distinguish the sexes viz; the curvature of the last abdominal sternite, when viewed laterally, curves more sharply downwards in the male and less so in the female (Roth and Wills, 1963; Beccari, 1967)

(Fig. 4); and also, the punctuation of the dorsal side of the rostrum distinguishes the sexes by being two thirds in the male and about one third in the female (Longoria, 1968). (Fig. 5).

Before the experiment was conducted, split pseudostem traps were placed over the entire area of the experimental arena for seven days. This was done to make sure that there were no other stray weevils in the vicinity. These traps were examined every day during this period.

The experiments were set up in the evenings, usually at sunset since the weevil is known to be very active during the night. The 100 insects were released in the centre of the arena on the soth split pseudostem.

The experimental design used was the Randomized Complete Block Design (RCBD) with four replications. Data, i.e. the number of weevils found on each treatment was recorded 24 hours after the weevils had been released. Mean separation was based on LSD test after ANOVA.

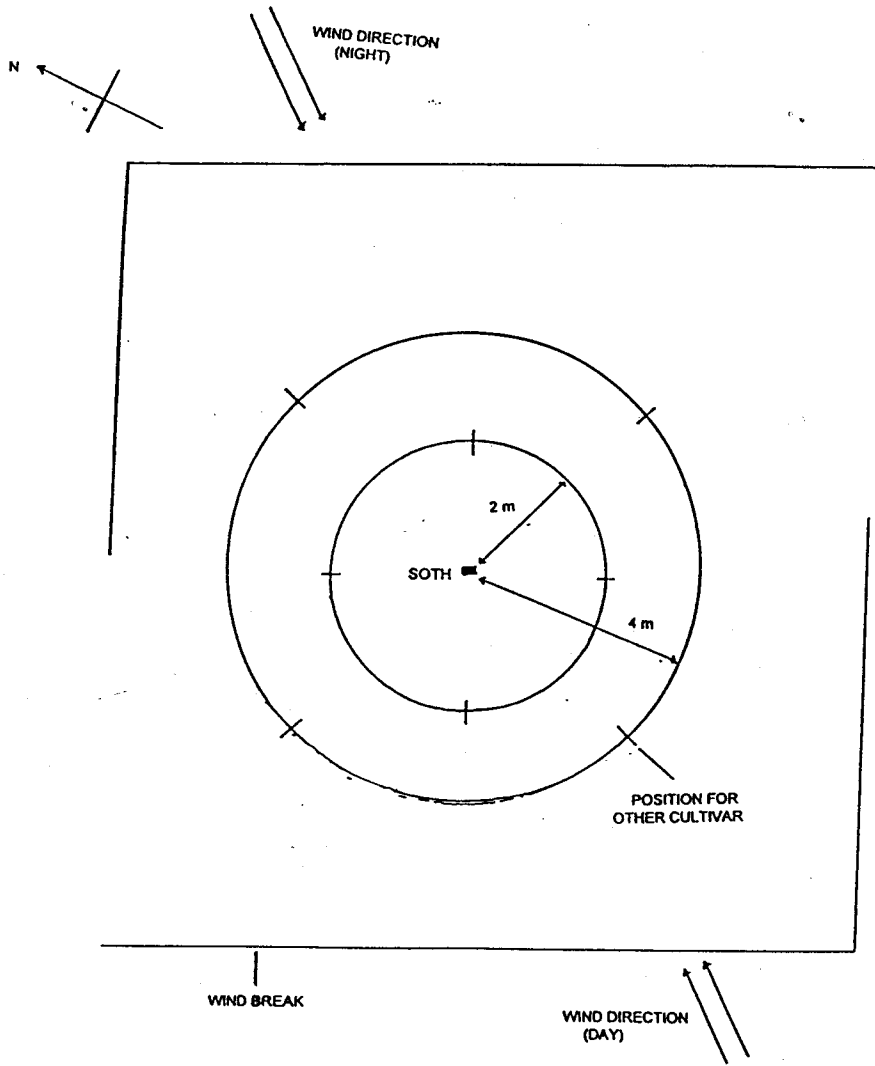

FIG. 3. Experimental arena for banana weevil movement between banana cultivars

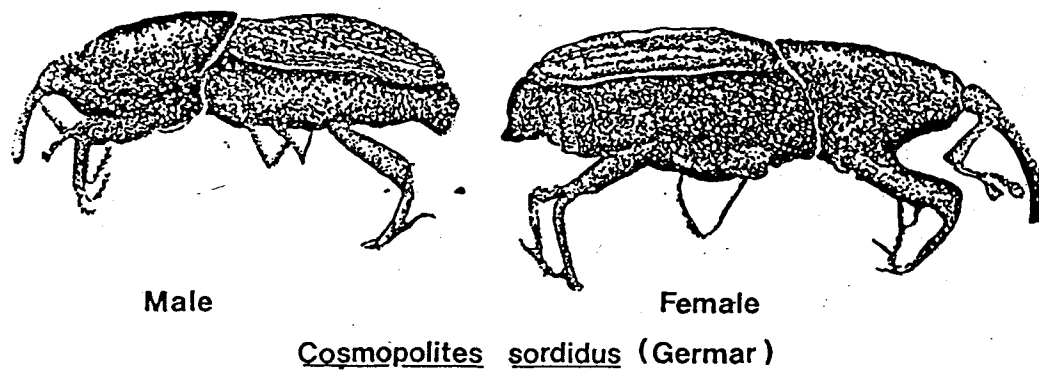

FIG. 4. Adult banana weevil showing the difference in curvature of the last abdominal sternite between male and female banana weevils

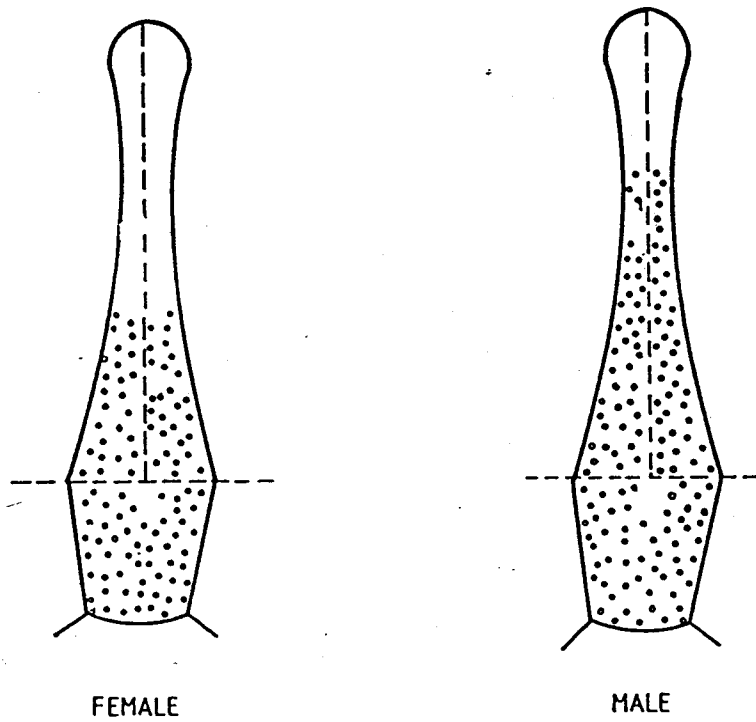

FIG. 5. Dorsal view of the rostrum of adult banana weevil showing difference in punctuation between male and female

3.8. PREFERENCE/NON-PREFERENCE OF BANANA WEEVIL FOR DIFFERENT BANANA CULTIVARS

3.8.1. OBJECTIVE

The objective of this study was to find out whether non-preference was the mechanism of resistance at play between the banana and the banana weevil.

3.8.2. MATERIALS AND METHODS

The experiment was conducted at MPFS. Six banana cultivars were used in this experiment.

The cultivars were:

1. Soth
2. Sukalindizi
3. Nakyetengu
4. Lusumba
5. Gonja
6. Mbidde

Rhizomes, 6 months old and of approximately equal size were used in this experiment.

In a dual choice set up, plastic basins 1 m in diameter and 0.50 m deep, were lined with soil. Rhizomes of two cultivars were placed at opposite ends (Plate 3).

Before the rhizomes were introduced into the basins, soil was washed off and the roots trimmed (not pared). Great care was taken not to damage the outer skin of the rhizome since this is the first area of contact between the banana weevil and the banana rhizome. The rhizomes were then treated with hot water (55°C) for 20 minutes (Prasad and Seshu Reddy, 1994). This was done to kill off any weevil eggs, larvae, pupae, or adults that may have been there. Two extra rhizomes of each cultivar were similarly treated and dissected to make sure that the treatment was effective. No weevil stages were found after the dissection.

After the hot water treatment, pseudostems were cut off leaving the rhizome alone. The rhizomes were then kept in a weevil free laboratory for two days in order to dry off the cut surfaces. This undertaking was necessitated by the fact that preliminary experiments had revealed that the weevils tended to aggregate on the moist cut surface. As an extra precaution against this, the cut surfaces were placed against the wall of the basin.

The rhizomes were placed in fifteen different combinations, viz:

1. Lusumba (AAA) vs Soth (AAB)
2. Lusumba (AAA) vs Sukalindizi (AB)

3. Lusumba (AAA) vs Mbidde (AAA)
4. Lusumba (AAA) vs Nakyetengu (AAA)
5. Lusumba (AAA) vs Gonja (AAB)
6. Soth (AAB) vs Sukalindizi (AB)
7. Soth (AAB) vs Mbidde (AAA)
8. Soth (AAB) vs Nakyetengu (AAA)
9. Soth (AAB) vs Gonja (AAB)
10. Sukalindizi (AB) vs Mbidde (AAA)
11. Sukalindizi (AB) vs Gonja (AAB)
12. Sukalindizi (AB) vs Nakyetengu (AAA)
13. Mbidde (AAA) vs Nakyetengu (AAA)
14. Mbidde (AAA) vs Gonja (AAB)
15. Gonja (AAB) vs Nakyetengu (AAA)

Ten, four to five day old adult (5 ♂, 5 ♀) weevils were placed in the centre of each basin containing the two rhizomes. The weevils were sexed as described in section 3.7.2. The basin was then covered with a piece of fine mosquito netting to prevent the weevils from escaping (Plate 4). A thermohygrograph was placed in between the basins to record the temperature and humidity of the laboratory during the experimental period.

The experiment was left to run for 40 days, keeping in mind that weevils take between 30 - 50 days (28°C and 68% RH) to complete development (Froggat, 1925 - 1928;

Viswanath, 1981; Hill, 1983; Bakyalire and Ogenga - Latigo, 1993). Some water was sprinkled over the basins once a week to keep the soil moist.



PLATE 3. Rhizomes placed at opposite ends of basin lined with soil

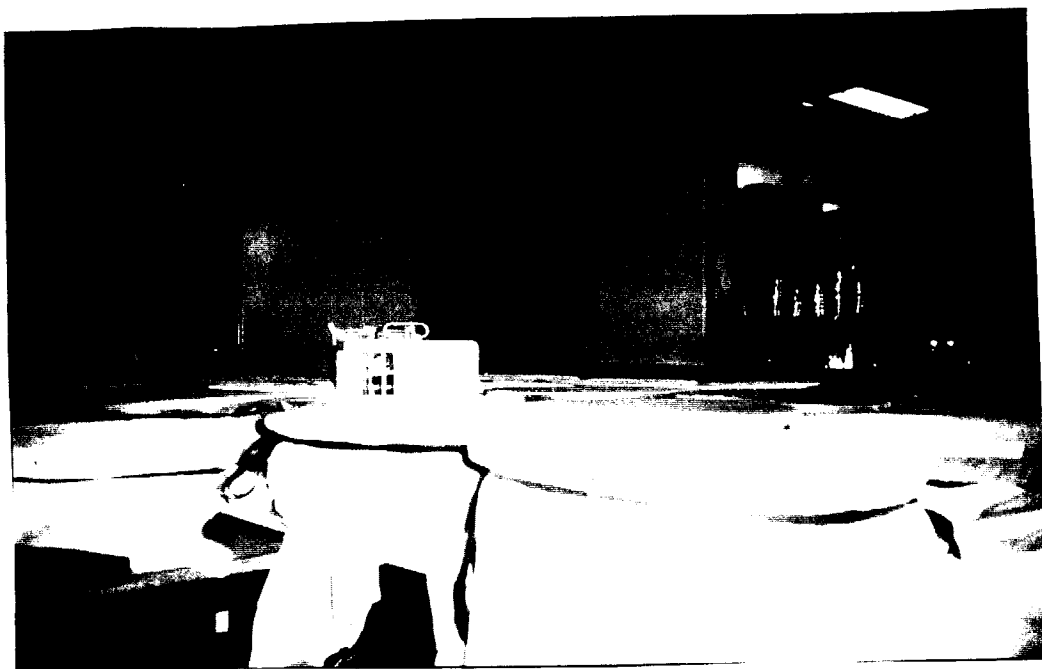

PLATE 4. The experimental set up showing the basins covered with fine mosquito netting

After 40 days, the treatments were dissected and examined and the following parameters recorded:

1. FEEDING RATIO (FR)

This was considered as the ratio of damage by the weevil on the rhizome; i.e. how much of the rhizome had been consumed by the weevil. It was recorded as a fraction, (1/4, 2/4 [1/2], 3/4 and 4/4 [1]).

2. FEEDING SEVERITY or INTENSITY (FS)

This referred to the extent or severity of the rhizome consumption by the weevil. It indicated the extent of larva feeding, and was recorded on a score basis, viz; 1 - 4;

1 = Little or no feeding

2 = Tunnel initiation into the rhizome

3 = Moderate tunnelling < 50% of rhizome consumed

4 = Extensive tunnelling > 50% of rhizome consumed.

3. FEEDING INDEX (FI)

This was calculated for each treatment (cultivar) using the FR and the FS; i.e. $FI = FR \times FS$. The FI provided the overall estimate of the weevil's preference for, and consumption of the test cultivar. The lowest possible value for FI was zero (0) and the highest 4. Statistical analysis was done by

Ttest. The FI was then used as a basis for comparing each cultivar with a susceptible and resistant check.

4. PREFERENCE RATIO (PR)

This parameter was computed in order to be able to make comparisons among the cultivars using the same check or control. The formula was first described by Kogan and Goeden (1970) and modified by Jackai (1991).

The PR is calculated as follows;

$$PR = 2(FI_{\text{test cultivar}}) \div (FI_{\text{control cultivar}} + FI_{\text{test cultivar}})$$

PR had a minimum value of zero (0) and a maximum value of 2; where $PR > 1$ indicated preference for the test cultivar and $PR < 1$ indicated preference for the control cultivar, $PR = 1$ meant there was no preference.

Mean separation was based on Duncan's multiple range test after ANOVA.

Soth and mbidde (resistant, and susceptible, respectively) were selected as checks after two preliminary experiments. The experiment was then repeated three times using them as checks.

3.9. BANANA RHIZOME NUTRITION STATUS

3.9.1. OBJECTIVE

The objective of this study was to determine whether there was any correlation between rhizome nutritional status, and age of the rhizome, weight of the rhizome and banana weevil population build-up.

3.9.2. MATERIALS AND METHODS

An experimental field plot was established at Ungoye Field Site. Before the land was cleared for banana planting split pseudostem traps were laid over the whole field. This was done to determine whether there were any weevils on the site. After three weeks of trapping, no weevils were recorded on the site.

The vegetation that was growing on the site was then slashed and raked to the edges. Holes for planting banana were then dug 2.5 m x 2.5 m apart and each was 60 cm deep. Each row of holes was planted with 15 banana suckers, each cultivar had 3 rows (i.e. 45 plants per cultivar). The banana suckers for planting were obtained from the Banana Germplasm at ICIPE's Ungoye Field Site (UFS). Sword suckers of approximately same age and size were used. Before planting the suckers were pared, that is, a thin layer of the rhizome skin was removed to expose and discard any weevil or nematodes

that might have been in the periphery. The pared rhizomes were then treated with hot water for 20 minutes at 55°C (Plate 5) as described by Prasad and Seshu Reddy, (1994). This treatment was used to kill any remaining weevils or nematodes without damaging the planting material. Two spade full of farm yard manure were applied to every hole at planting.

All agronomic practices pertaining to banana husbandry were followed.

Sampling was done at 4, 8, 12, 16, and 20 months after planting. Two plants were randomly selected from each cultivar at each sampling time. Care was taken to ensure that each plant that was sampled was always surrounded by plants of the same cultivar. The following records were taken:

1. Age of the plant
2. Number of suckers per stool sampled
3. Weight of rhizome (as a measure of rhizome density or firmness)
4. Visual damage rating of the rhizome
5. Total weevil count (all stages of the weevil found on the rhizome or pseudostem after dissection)
6. Chemical analysis for macro and micro nutrients viz;
nitrogen, phosphorous, potash, sulphur, calcium, magnesium, manganese, copper, zinc, and iron. The analyses were carried out by Chemists at the

Kenya Agricultural Research Institute, (KARI).

The data was subjected to correlation analysis. Mean separation was based on Tukey's Studentized Range after ANOVA.



PLATE 5. Pared suckers after being treated with hot water before planting

CHAPTER 4

RESULTS

4.1. BANANA CULTIVAR CHARACTERIZATION

4.1.1. VEGETATIVE CHARACTERS

Twelve (12) vegetative banana characters were examined:

Leaf orientation:

All the cultivars examined showed that their leaves were erect, except for mbidde whose leaf orientation was neither erect nor drooping.

Leaf colour:

All the cultivars had green leaves. As for mbidde, 80% of the leaves examined were green in colour while the remaining 20% had some red streaks along the margins.

Leaf margins:

The leaf margins were smooth (entire) in all the cultivars.

Leaf lamina shape:

Lusumba, nakyetengu, soth, sukalindizi, and 20% of mbidde showed their leaf lamina to have been neither broad nor elongate; whereas 80% of mbidde had broad leaves and gonja had elongate type

leaf lamina.

Petiole clasping:

The petiole in all the cultivars did not clasp the pseudostem as the leaf lamina opened out.

Petiole colour:

All petioles examined were green.

Suckering:

All cultivars had many suckers (more than 3) growing freely on every mat.

Sucker orientation:

All the suckers of all the cultivars were erect.

Pseudostem colour:

Gonja and soth had green-yellow pseudostems, while lusumba, nakyetengu, mbidde, and sukalindizi had green pseudostems.

Pseudostem blotches:

Lusumba, mbidde, and nakyetengu displayed extensive blotches; while soth and sukalindizi had very slight with gonja having none at all.

Pseudostem blotches colour:

Of the cultivars that had blotches, only soth showed brown blotches; The rest of the cultivars had black ones.

Pseudostem waxiness:

All the cultivars were slightly waxed.

4.1.2. INFLORESCENCE CHARACTERS

Nine (9) inflorescence features were looked at:

Peduncle hairiness:

All the cultivars had a glabrous peduncle, except mbidde whose peduncle was finely hairy.

Angle of female axis:

The angle of the female axis in all the cultivars was subhorizontal.

Angle of male axis:

Lusumba, mbidde, and 20% of nakyetengu had erect male axis, while gonja, sukalindizi, 80% of nakyetengu and soth were subhorizontal and only 20% of soth were pendulous.

Male bud:

The male bud was present in all the cultivars.

Bunch:

The bunches of lusumba and soth were rather lax when compared to those of gonja, mbidde, nakyetengu, and sukalindizi which were dense.

Colour of immature fruit:

The fruits from all the cultivars were green when immature.

Fruit apex:

All the fruits from the cultivars had a bottle-neck shaped apex.

Fruit cross-section:

The cross-section of the fruits was angular in all the cultivars.

Fruit parthenocarpy:

All the fruits were parthenocarpic.

4.1.3. MALE FLOWER CHARACTERS

Sixteen features of the male flower were examined:

Compound tepal colour:

Gonja had orange-yellow coloured compound tepals, while soth and 80% of lusumba displayed an orange-white colour; and mbidde, nakyetengu, sukalindizi and 20% of lusumba showed a yellow colour.

Compound tepal purple tinge:

Soth, 80% of sukalindizi, and 40% of lusumba had a purple tinge on the compound tepal, the rest of the cultivars did not show the purple tinge.

Ovary colour:

Lusumba, gonja, mbidde, and sukalindizi had a white ovary; nakyetengu and soth had a greenish and reddish coloured ovary respectively.

Stigma colour:

Mbidde, nakyetengu, soth, sukalindizi and 60% of lusumba showed an orange-yellow stigma; while the stigma of gonja and 40% of lusumba was

white-yellow.

Style purple tinge:

All cultivars except for 20% of lusumba did not have a purple tinge on their styles.

Staminode purple tinge:

The staminode had a purple tinge in cultivars mbidde, nakyetengu, sukalindizi, and 20% of lusumba. The remaining cultivars did not show this character.

Free tepal transparent:

The free tepals were transparent in all the cultivars.

Free tepal corrugated:

The free tepals were corrugated in all the cultivars.

Pollen:

None of the cultivars had pollen.

Bract scars on male axis:

The bract scars on the male axis were prominent in all the cultivars.

Male bud imbrication:

The male bud was imbricated in all the cultivars.

Bract waxiness:

The bracts were slightly waxed in all the cultivars.

Male bracts:

The male bracts were deciduous in all the cultivars.

Male bract apex:

The apex of the male bract was acute in all the cultivars.

Male bract internal colour:

The internal colour of the male bracts was bright crimson in gonja, nakyetengu, soth, sukalindizi, and 20% of lusumba; mbidde, and 20% of lusumba had yellow to bronze and fading-like internal colour of the male bracts respectively.

Male bract external colour:

All the cultivars had a red to purple male bract external colour.

4.1.4. FRUIT CHARACTERS

Seed:

All the fruits from all the cultivars had no seeds.

Taste:

The fruits from cultivars lusumba, mbidde, sukalindizi, nakyetengu, and soth were sweet and aromatic. Gonja on the other hand was very starchy.

Colour of ripe fruit peel:

The colour of the ripe peel was yellow in all the cultivars.

Colour of ripe fruit pulp:

All the cultivars had a creamy pulp when ripe.

4.2. BANANA WEEVIL ORIENTATION TOWARDS DIFFERENT BANANA PLANT PARTS

In this experiment it was found that more weevils were attracted ($P \leq 0.05$) to the pseudostem plant pieces than to the rhizome (Table 1; Appendix 5). A mean of 41 out of the one hundred insects released were recorded on the pseudostem pieces compared to 23 recorded on the rhizome pieces. There was no significant difference ($P \leq 0.05$) between the number of weevils recorded on the pseudostem/rhizome junction and those recorded on the pseudostem or the rhizome.

4.3. BANANA WEEVIL ORIENTATION/ARREST TOWARDS DIFFERENT BANANA CULTIVARS (LAB. EXPERIMENT)

The results of the orientation experiment conducted in the laboratory are shown in Table 2 (see also Appendix 6). There were no significant differences ($P \leq 0.05$) between the mean number of weevils recorded on cultivars nakyetengu (22.17), gonja (21.50), and sukalindizi (18.67).

Also, there were no differences ($P \leq 0.05$) between the mean number of weevils recorded on lusumba (13.67), mbidde (14.00) and sukalindizi (18.67). The same is true for lusumba (13.67), mbidde (14.00) and soth (8.83).

However, significant differences ($P \leq 0.05$) were recorded between nakyetengu (22.17), gonja (21.50), sukalindizi (18.67) on one hand, and soth (8.83), on the other. Cultivars nakyetengu (22.17), and gonja (21.50) also showed significant differences when compared to mbidde (14.00) and lusumba (13.67).

4.4. BANANA WEEVIL ORIENTATION/ARREST TOWARDS DIFFERENT BANANA CULTIVARS (FIELD EXPERIMENT)

The results of the orientation experiment conducted in the field are shown in Table 3. The results were very similar to those observed in the laboratory. When the total weevil count (regardless of sex) was used in the computation, it was found that there were significant differences in the mean number of weevils recorded on lusumba (14.00), and sukalindizi (14.00) to those recorded on nakyetengu (5.50). No differences were found between mbidde (6.00) and the other cultivars.

When the weevil counts recorded were separated into males and females, it was found that there were no significant differences in the mean male counts (Table 4) between lusumba (21.00), sukalindizi (15.00), and mbidde (8.00). A significant difference was found between lusumba (21.00) and nakyetengu (4.50).

There were no significant differences in the mean female weevil counts recorded on each cultivar (Table 5).

4.5. BANANA WEEVIL MOVEMENT BETWEEN DIFFERENT BANANA CULTIVARS

The results of the experiment are shown in Figs. 6, 7 and 8 (see also appendices 7, 8, and 9).

When the weevil count was not separated into males or females, a significant ($P \leq 0.05$) difference in the mean number of weevils that were retained on resistant soth (27.75) compared to the numbers that had moved and were recorded on susceptible cultivar gonja at 2 metres and 4 metres (14.00 and 7.50 respectively). However, of the weevils that had moved to gonja, there was a significant ($P \leq 0.05$) difference in the weevil counts at 2 metres (14.00) and 4 metres (7.50).

This same combination (soth vs gonja) also showed that more male weevils were retained on soth (25.50) than had moved to gonja at the two distances (12.50 and 7.50 respectively). The mean female weevil count also showed a similar trend, soth retained more females (30.00) compared to 2 metres (15.50) and at 4 metres (8.00). The female counts were not significant at 2 and 4 metres.

Significant ($P \leq 0.05$) differences were also shown in the soth (resistant) vs mbidde (susceptible) combination. In this case, a higher mean number of weevils moved from soth (7.29) and got arrested on mbidde; more being at 2 metres (22.50) than at 4 metres. A similar trend was observed in the male counts; more moved and were arrested on

mbidde at 2 metres (18.00) than at 4 metres (11.00) compared to the ones retained on soth (7.5). The mean male weevil count on soth was not significantly different from that at 4 metres. There were no significant ($P \leq 0.05$) differences in the means as regards the female counts.

The other combinations i.e. soth (resistant) vs lusumba (susceptible), soth vs nakyetengu (susceptible), soth vs sukalindizi (moderately resistant) and the control soth vs soth, showed no significant ($P \leq 0.05$) differences between mean number of weevils retained at the centre (soth), to those that moved and got arrested on the surrounding cultivars both at 2 and 4 metres. The same was observed for the males and females.

TABLE 1. **BANANA WEEVIL ORIENTATION/ARREST TOWARDS DIFFERENT BANANA PLANT PARTS**

WEEVILS RECORDED 24 HOURS AFTER RELEASE	
TREATMENT	MEAN \pm S.E.
Pseudostem	41.33 \pm 4.35 a
Pseudostem/rhizome	32.17 \pm 4.59 ab
Rhizome	23.17 \pm 3.68 b

LSD = 12.74

Means followed by the same letter are not significantly different ($P \leq 0.05$); LSD test.

TABLE 2. **BANANA WEEVIL ORIENTATION/ARREST TOWARDS DIFFERENT BANANA CULTIVARS (LAB. EXPERIMENT)**

WEEVILS RECORDED 24 HOURS AFTER RELEASE	
TREATMENT	MEAN \pm S.E.
Nakyatengu	22.17 \pm 3.35 a
Gonja	21.50 \pm 1.61 a
Sukalindizi	18.67 \pm 3.43 ab
Mbidde	14.00 \pm 2.29 bc
Lusumba	13.67 \pm 2.24 bc
Soth	8.83 \pm 1.74 c

LSD = 7.44

Differences between means followed by the same letter are not significantly different ($P \leq 0.05$); LSD test.

TABLE 3. **BANANA WEEVIL ORIENTATION/ARREST TOWARDS DIFFERENT BANANA CULTIVARS (FIELD EXPERIMENT)**

- TOTAL WEEVIL COUNT

TREATMENT	WEEVILS RECORDED 24 HOURS AFTER RELEASE	
	MEAN \pm S.E.	
Lusumba	14.00 \pm 1.96 a	
Sukalindizi	14.00 \pm 2.68 a	
Mbidde	6.00 \pm 1.29 ab	
Nakyatengu	5.50 \pm 1.19 b	

Differences between means followed by the same letter are not significantly different ($P \leq 0.05$); Tukey's Studentized Range test on arcsine transformed data ($x + 0.5$).

TABLE 4. **BANANA WEEVIL ORIENTATION/ARREST TOWARDS DIFFERENT BANANA CULTIVARS (FIELD EXPERIMENT)**

- MALE WEEVIL COUNTS

TREATMENT	MALE WEEVILS RECORDED 24 HOURS AFTER RELEASE	
	MEAN \pm S.E.	
Lusumba	21.00 \pm 2.89 a	
Sukalindizi	15.00 \pm 2.52 ab	
Mbidde	8.00 \pm 2.00 ab	
Nakyatengu	4.50 \pm 1.71 b	

Differences between means followed by the same letter are not significantly different ($P \leq 0.05$); Tukey's Studentized Range on arcsine transformed data ($x + 0.5$).

TABLE 5. **BANANA WEEVIL ORIENTATION/ARREST TOWARDS DIFFERENT BANANA CULTIVARS (FIELD EXPERIMENT)**

- FEMALE WEEVIL COUNT

FEMALE WEEVILS RECORDED 24 HOURS AFTER RELEASE	
TREATMENT	MEAN \pm S.E.
Sukalindizi	10.50 \pm 3.30 a
Lusumba	9.50 \pm 4.27 a
Nakyatengu	6.50 \pm 0.96 a
Mbidde	4.00 \pm 1.63 a

Differences between means followed by the same letter are not significantly different ($P \leq 0.05$); Tukey's Studentized Range on arcsine transformed data ($x + 0.5$).

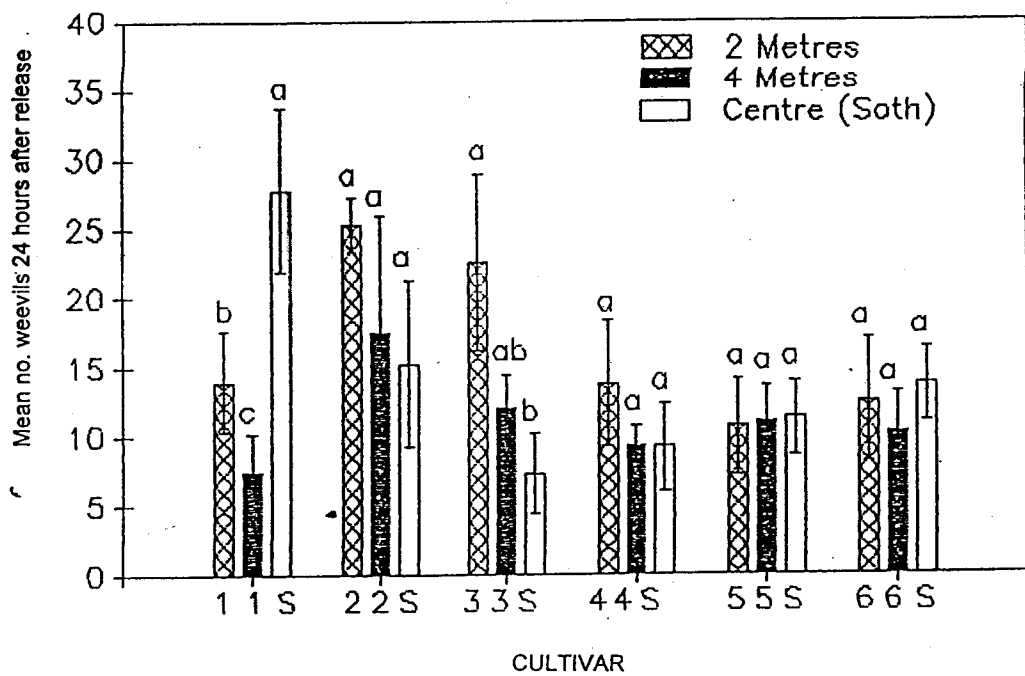

Legend:

S = Soth 1 = Gonja 2 = Lusumba 3 = Mbidde
 4 = Nakyatengu 5 = Sukalindizi 6 = Soth

Fig. 6. Weevil movement between banana cultivars
 (Total weevil count)

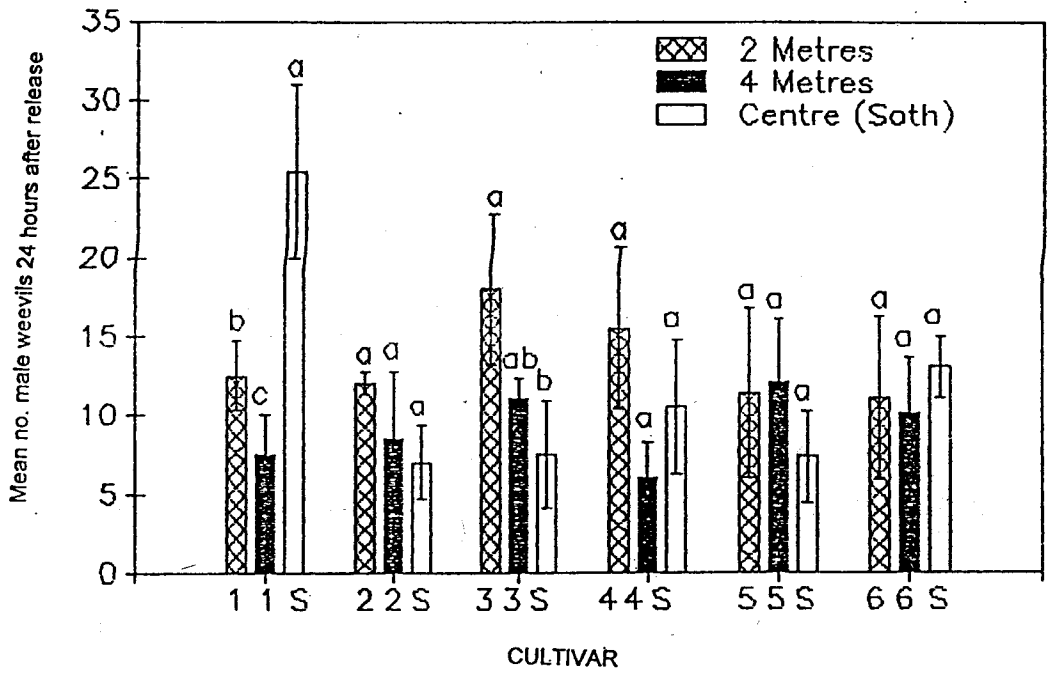

Legend:

S = Soth 1 = Gonja 2 = Lusumba 3 = Mbidde
 4 = Nakyetengu 5 = Sukalindizi 6 = Soth

Fig. 7. Weevil movement between banana cultivars
 (Male weevil count)

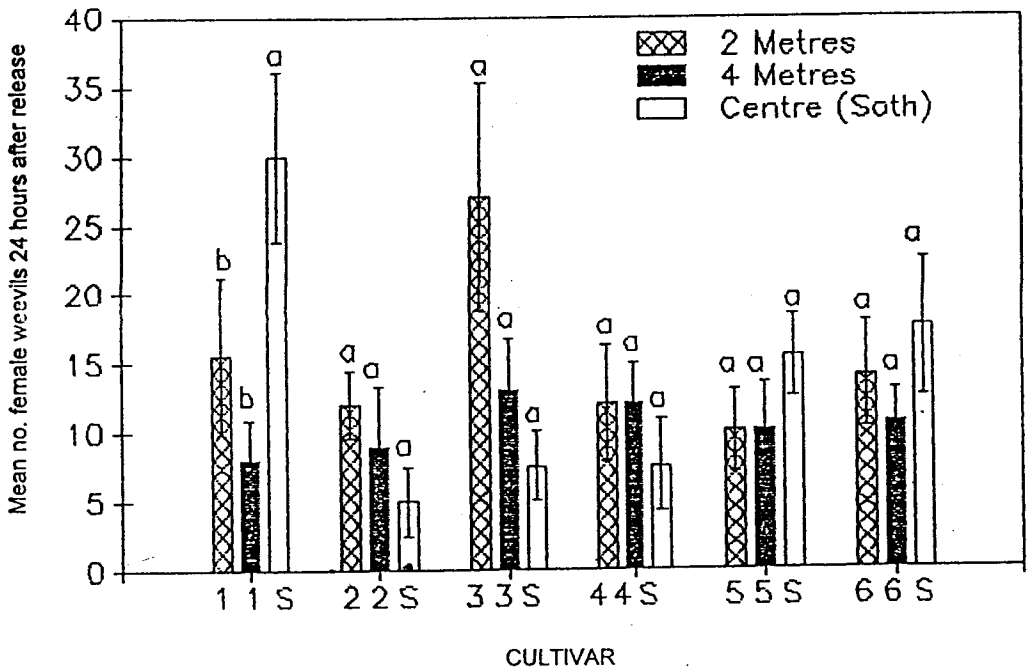

Legend:

S = Soth 1 = Gonja 2 = Lusumba 3 = Mbidde
 4 = Nakyatengu 5 = Sukalindizi 6 = Soth

Fig. 8. Weevil movement between banana cultivars
 (Female weevil count)

4.6. PREFERENCE/NON-PREFERENCE OF THE BANANA WEEVIL FOR DIFFERENT BANANA CULTIVARS

Table 6 shows the feeding indices (FI) for each cultivar tested against the same checks, mbidde and soth.

When tested against mbidde (susceptible), there was a significant ($P \leq 0.05$) difference in FI between mbidde (2.25) and lusumba (susceptible) (0.25). When lusumba (0.92) was tested against soth (resistant) (0.58) the difference in their FI was not significant.

The FI for sukalindizi (moderately resistant)(1.42), nakyatengu (susceptible)(1.08) and gonja (susceptible)(1.08) when tested against mbidde were not significantly ($P \leq 0.05$) different (0.75, 1.00, and 1.66 respectively). However, when the same cultivars were tested against soth, there was a significant ($P \leq 0.05$) difference in FI for gonja (2.83) and none for the others.

The preference ratio (PR) results (Table 7) showed that there were no significant ($P \leq 0.05$) differences in mean separation between the cultivars when tested against soth. Significant differences ($P \leq 0.05$) were found when sukalindizi and lusumba were tested against mbidde. There were no differences between sukalindizi, nakyatengu, and gonja when compared to mbidde. The same was found between lusumba, nakyatengu and gonja.

TABLE 6. **PREFERENCE/NON-PREFERENCE OF BANANA WEEVIL FOR DIFFERENT BANANA CULTIVARS**

Feeding indices (FI) of banana cultivars tested against susceptible check mbidde and resistant check soth

CULTIVAR	MBIDDE	SOTH
Lusumba	0.25* (2.25)	0.92 ^{ns} (0.58)
Sukalindizi	1.42 ^{ns} (0.75)	1.25 ^{ns} (0.25)
Nakyatengu	1.08 ^{ns} (1.00)	1.58 ^{ns} (2.08)
Gonja	1.08 ^{ns} (1.66)	2.83* (0.71)

* = $P \leq 0.05$ ns = not significant

The values in parentheses are feeding indices of checks for each paired comparison.

TABLE 7. **PREFERENCE/NON-PREFERENCE OF BANANA WEEVIL FOR DIFFERENT BANANA CULTIVARS**

Preference ratios (PR) of banana cultivars tested against susceptible check mbidde and resistant check soth

CULTIVAR	MBIDDE (± S.E.)	SOTH (± S.E.)
Gonja	0.82 ab (± 0.36)	1.85 a (± 0.83)
Lusumba	0.21 b (± 0.04)	1.45 a (± 0.39)
Nakyatengu	1.05 ab (± 0.42)	1.30 a (± 0.55)
Sukalindizi	1.35 a (± 0.27)	1.57 a (± 0.15)

Differences between means in the same column followed by the same letter are not significantly different ($P \leq 0.05$); Duncan's multiple range test on square root transformed data.

4.7. BANANA RHIZOME NUTRITION STATUS

The results of the ANOVA tests conducted on banana rhizome nutrition status are presented in Appendix 10 and a summary of these in Table 8. The quantity of both the micro and macro nutrients showed no significant differences ($P \leq 0.05$) between the six cultivars. However, nitrogen ($P \leq 0.01$), phosphorous, magnesium, sulphur and iron were significant ($P \leq 0.05$) over time. From the data, nitrogen and iron increased in all the cultivars, whereas phosphorous declined in all except in mbidde, there was no change over the 20 months from planting. Magnesium also showed slight increase in lusumba, mbidde, nakyetengu and gonja but there was no change in its quantity in cultivars soth and sukalindizi. A similar trend was seen in the levels of sulphur, only in this case, slight declines were noticed in soth, lusumba, and nakyetengu. No changes were observed in the levels of sulphur in mbidde, sukalindizi, and gonja.

The rhizome weight, which was used to give an indication of rhizome firmness, showed no significant differences ($P \leq 0.05$) among the six cultivars. It was also not significant over the growing period. The number of suckers that were produced by each cultivar was also not significantly different ($P \leq 0.05$).

The weevil counts on the six cultivars were significantly different ($P \leq 0.05$). The mean number of weevils found on soth were not significantly different from those found on sukalindizi, mbidde, lusumba, and gonja; but significantly different from those found on

nakyatengu. However, the weevil numbers found on nakyatengu were also not significantly different from the numbers found on mbidde, lusumba, and gonja.

TABLE 8. BANANA RHIZOME NUTRITION STATUS

ELEMENT	GONJA	LUSUMBA	MBIDDE	NAKAYETENGU	S/NDIZI	SOTH
Nitrogen	1.38 ± 0.55a	0.96 ± 0.36a	1.38 ± 0.64a	1.04 ± .39a	0.88 ± 0.32a	0.84 ± 0.42a
Phospho.	0.12 ± 0.01a	0.11 ± 0.04a	0.11 ± 0.003a	0.12 ± .01a	0.11 ± 0.03a	0.09 ± 0.02a
Potassium	4.09 ± 0.51a	3.02 ± 0.52a	3.01 ± 0.81a	4.1 ± 0.71a	3.44 ± 0.02a	2.86 ± 0.18a
Calcium	0.42 ± 0.33a	0.48 ± 0.05a	0.44 ± 0.60a	0.48 ± .03a	0.42 ± 0.02a	0.39 ± 0.07a
Magnesium	0.29 ± 0.07a	0.32 ± 0.09a	0.23 ± 0.05a	0.3 ± 0.07a	0.2 ± 0.003a	0.23 ± 0.01a
Sulphur	0.03 ± 0.01a	0.05 ± 0.01a	0.03 ± 0.003a	0.04 ± .01a	.03 ± 0.003a	0.03 ± 0.01a
Copper	4.8 ± 0.16a	4.87 ± 0.59a	4.20 ± 0.20a	4.5 ± 0.47a	3.53 ± 0.47a	4.27 ± 0.93a
Manganese	18.4 ± 0.83a	21.6 ± 2.67a	21.93 ± 1.92a	21.5 ± 2.9a	21.7 ± 2.9a	25.9 ± 1.04a
Iron*	426 ± 139.72a	248 ± 25.2a	429 ± 177.6a	553 ± 378a	221.7 ± 46a	177.7 ± 37.8a
Zinc	8.73 ± 1.75a	20.0 ± 10.3a	10.7 ± 0.67a	12.5 ± 2.7a	7.73 ± 1.18a	7.8 ± 0.2a
Rhiz. Wt	20.75 ± 2.4a	22.9 ± 3.9a	16.05 ± 0.95a	18 ± 4.00a	26.9 ± 5.4a	20.25 ± 2.5a
Suckers	7.00 ± 1.00a	8.00 ± 1.5a	4.33 ± 0.33a	6.33 ± .33a	7.00 ± 0.6a	7.33 ± 2.8a
Weevils*	3.00 ± 2.1ab	1.7 ± 0.88ab	6.00 ± 3.1ab	6.00 ± 2.1a	0.00 ± 0.00b	0.00 ± 0.00b

Figures are composed of Mean ± S.E. Differences between means in the same row followed by the same letter are not significantly different ($P \leq 0.05$); Tukey's Studentized Range test.

* Tukey's Studentized Range test on square root transformed data.

The correlation analysis results are shown in Table 9. There was a strong correlation between time (age of the plants from date of planting) and the weight of the rhizomes (0.8660) as well as the number of suckers (0.6187) per stool over the same period.

Nitrogen was correlated to time (0.6345) and the number of weevils (0.6701) found on the cultivars. Phosphorous, on the other hand, was negatively correlated to time (-0.6857) and rhizome weight (-0.7578) and not correlated to weevil count. Magnesium was correlated to time (0.6395) and rhizome weight (0.5262) and very weakly correlated to weevil (0.4134) count. Sulphur was negatively correlated to rhizome weight (-0.6665) and not correlated to time, number of suckers or the number of weevils. The remaining nutrients showed very weak correlations to time, rhizome weight, number of suckers and weevil counts. Rhizome weight showed a very weak correlation to weevil counts.

TABLE 9. BANANA RHIZOME NUTRITION STATUS

- CORRELATION MATRIX

	TIME (MAP)	RHIZ.Wt.	SUCKERS	WEEVILS
Time (MAP)	1.0000	0.8660	0.6187	0.2886
Nitrogen	0.6345	0.2458	0.3230	0.6701
Phosphorous	-0.6857	-0.7578	-0.3348	0.0548
Potassium	-0.2091	0.0156	-0.2422	0.0038
Calcium	-0.3177	-0.1295	-0.5484	-0.0165
Magnesium	0.6395	0.5262	0.3933	0.4134
Sulphur	-0.3995	-0.6665	-0.1360	0.1902
Copper	-0.4046	-0.4839	-0.3695	0.2473
Manganese	-0.2608	-0.3337	-0.0756	-0.2661
Iron	0.2977	0.3434	0.0701	-0.0144
Zinc	-0.0880	0.0218	-0.0908	-0.0088
Rhiz. Wt.		1.0000	0.4083	0.0555
Suckers			1.0000	-0.0907
Weevil				1.0000

MAP = Months after planting.

CHAPTER 5

DISCUSSION, CONCLUSIONS AND RECOMMENDATIONS

5.1. BANANA WEEVIL ORIENTATION TOWARDS DIFFERENT BANANA PLANT PARTS

From the experiment, the weevils preferred the pseudostem to the rhizome ($P \leq 0.05$). They were indifferent when it came to choosing between pseudostem, or rhizome and the pseudostem/rhizome junction (Table 1).

These results were similar to those obtained by Ndiege et al., (1990) who found 78% males and 84% females being attracted to the pseudostem. Pseudostems have also been found to be most attractive to weevils when used as traps or simply left in the field as debris (Frogatt, 1926, 1928; Wallace, 1937, 1938; Ostmark, 1974; Seshu Reddy, et al., 1994).

It has been shown that weevils like to shelter in banana litter usually made up of cut pseudostems where the humidity is high (Roth and Willis, 1963; Stover, 1989). The pseudostems are much more succulent when compared to the rhizomes and as such are preferred much more than rhizomes by the weevil.

On the basis of these results, the pseudostem was chosen as the ideal banana plant part to use in subsequent experiments in the study.

5.2. BANANA WEEVIL ORIENTATION/ARREST TOWARDS DIFFERENT BANANA CULTIVARS (LABORATORY AND FIELD EXPERIMENTS)

Orientation is an insect behavioural response which determines the initial selection or rejection of a plant host. As such, to determine the principles governing the susceptibility/resistance of plants to an insect species, it is necessary to compare the orientation responses to susceptible and resistant cultivars (Saxena, 1985).

In the laboratory experiment, resistant cultivar soth (AAB) attracted less weevils to orient (arrest) towards it than susceptible cultivars nakyetengu (AAA), gonja (AAB), and the moderately resistant cultivar, sukalindizi (AAA). Even the susceptible cultivars showed differential response among themselves (Table 2). Nakyetengu (AAA) and gonja (AAB) being more attractive than mbidde (AAA) and lusumba (AAA) ($P \leq 0.05$). The moderately resistant cultivar sukalindizi (AB) attracted the same number of weevils as the susceptible cultivars. It is interesting to note that even though resistant cultivar soth (AAB) attracted less weevils than susceptible cultivars lusumba (AAA) and mbidde (AAA), the difference was however not significant ($P \leq 0.05$).

From this experiment it was clear that the resistant cultivar soth attracted less weevils

than all the susceptible cultivars, including the moderately resistant cultivar sukalindizi (AB). However, differences were evident among the susceptible cultivars in their levels of attractiveness ($P \leq 0.05$). The moderately resistant cultivar sukalindizi (AB) attracted as many weevils as the susceptible cultivars, bringing to doubt its level of resistance as determined by Seshu Reddy and Lubega (1993).

Since the experiment was conducted in the laboratory using a choice chamber, with not much air (volatile) movement; there was a danger of a volatile (semiochemical) concentration build-up and mixing, thus confusing the weevils in their selection. To check against this, the experiment was repeated in the field (section 3.6). Due to paucity of pseudostems of the same age, only four of the six cultivars were used in the field experiment. The results were not very different from those obtained in the laboratory.

Susceptible cultivar lusumba (AAA) and moderately resistant cultivar sukalindizi (AB) attracted more weevils than susceptible cultivar nakyetengu (AAA) ($P \leq 0.05$). The cultivars mbidde (AAA) and nakyetengu (AAA) attracted a similar number of weevils (Table 3).

In the laboratory experiment, susceptible cultivar nakyetengu (AAA) had attracted the highest number of weevils, but it attracted the least in the field experiment; which compared mostly susceptible cultivars with one moderately resistant.

When the weevil counts were separated into males and females; the pattern of male attraction to the different cultivars was similar to the one described above for the total weevil count (Table 4). The only difference was that the moderately resistant cultivar sukalindizi (AB) attracted as many males as susceptible cultivars mbidde (AAA) and nakyetengu (AAA). Indeed 98% of all the males that had been released settled selectively on the different banana cultivars.

The females were attracted equally ($P \leq 0.05$) to all the cultivars regardless of the resistant/susceptibility status (Table 5). However, 64% of those released settled on the various cultivars.

Budenberg *et al.*, (1991), demonstrated that males produced an aggregation pheromone which elicited positive response in both males and females. From this experiment, it has been shown that weevils, especially the males, settle selectively on different banana cultivars (more on susceptible ones) from where they probably release their pheromone to attract the females for mating. A similar phenomenon was observed by Spiejer *et al.*, (1993) who found that, the number of males correlated well with the percentage coefficient of infestation (PCI) at harvest when compared to that of the females. This was probably due to the fact that the males remained in the immediate vicinity of the stool from which they had emerged. The females on the other hand had a higher tendency to disperse after emergence and mating (Treverrow, *et al.*, 1992).

5.3. BANANA WEEVIL MOVEMENT BETWEEN DIFFERENT BANANA CULTIVARS

Banana weevils, which were observed in the orientation experiment, were able to discriminate between resistant and susceptible cultivars, in fact, they were even able to differentiate between the susceptible cultivars; showing that the level of susceptibility was different among the cultivars.

It has been reported that in a subsistence farmers' field, both resistant and susceptible cultivars are grown side by side. These farmers are constantly introducing new cultivars from their neighbours' fields. These new planting materials bring with them banana weevils which may spread in the already existing plantation (Seshu Reddy *et al.*, 1994).

The weevils choose which particular cultivar to colonize, and a number of factors determine the selection of one cultivar from another. Baliddawa (1985) discovered that, when an insect was on a plant, two things were responsible for the rejection of the plant by the potential pest; (i) the physical condition of the plant surface may be unsuitable, or, (ii) the gustatory cues may be unacceptable.

As such, before the relationship between the physical and nutritional status of the banana cultivars and rejection of the plant by the potential pest were discovered, the movement of the banana weevil, especially off resistant cultivars, was emphasized. Presently it is accepted that the movement of the insects off one cultivar to another could be used as a

measure of non-preference (Wiseman *et al.*, 1983).

The results of the experiment showed that when weevils were released on resistant cultivar soth (AAB), there were no differences in the number of weevils that moved off soth to any of the susceptible cultivars; lusumba (AAA), mbidde (AAA), nakyetengu (AAA), or even the moderately resistant cultivar sukalindizi (AB). In fact, more weevils were retained on soth than had moved and settled on susceptible cultivar gonja (AAB). The control (soth vs soth) showed the same result, there was no difference in the number that had moved to those which were retained.

The number of weevils that moved off soth and settled on the other cultivars at the two distances (two metres and four metres) also showed no differences ($P \leq 0.05$). It was only in cultivar gonja were more settled at two metres than did at four.

The movement of the sexes is very similar to that described in 5.2 above. It was only in the soth/gonja combination that more males were retained on soth than had moved and settled on gonja.

However, from the results of this experiment (as well as the orientation experiment conducted in the field), the percentage of weevils that moved and were not attracted (arrested) to any cultivar is rather high compared to the percentage that were retained on soth or got arrested on the surrounding cultivars. In the soth vs gonja combination, 50%

where not accounted for, soth/lusumba 42%, soth/mbidde 68%, soth/sukalindizi 69%, and the control soth/soth 63%.

These observations are probably attributed to the facts that, (i) the experimental arena may have been so bare, that the weevils responded to the stimuli (humidity) from the area surrounding the arena since vegetation was growing freely (Roth and Willis, 1963; Stover, 1989; and Treverrow et al., 1992), and weevils are capable of surviving for long periods without food (de Jager, 1993), and (ii) the area surrounding the experimental arena was over grown by different plant species, including *Panicum maximum* which is known to be an alternative host for the banana weevil (Beccari, 1967; Seshu Reddy et al., 1994). However, the weevil does not normally oviposit on the alternate hosts (Martinez et al., 1990) but it can visit the latter for shelter, especially if the relative humidity on such hosts is favourable.

As was mentioned above (5.2), more males were attracted to and arrested on banana than those which went astray compared to the females. This can be attributed to the fact that females disperse and wonder around much more than males as they (female) respond to higher humidities (Roth and Willis, 1963).

The observation that the number of weevils that were retained on resistant cultivar 'soth' were not significantly different from the numbers that moved off soth and got arrested on both resistant and susceptible cultivars suggests that the selection of cultivars by the

banana weevil for colonization was fine tuned and did not depend on distant perceivable stimuli. This is in consistence with previous observation by Ndiege *et al.*, (1990, 1991a).

5.4. PREFERENCE/NON-PREFERENCE OF BANANA WEEVILS FOR DIFFERENT BANANA CULTIVARS

The observation in the dual choice experiments that the banana weevils discriminately choose banana hosts to colonize suggests that the weevil is specific to banana species. This confirms previous reports by Moznette (1920), Froggatt (1925), Greenwell (1944), Harris (1947), Cheeseman (1948), Simmonds (1966), Mitchell (1978), De Langhe (1986), Zimmerman (1968a), INIBAP (1987), Stover and Simmonds (1987), Stover (1989), Treverrow *et al.* (1992), de Jager (1993), and Seshu Reddy *et al.*, (1994). In fact some workers are of the opinion that the weevil and the banana coevolved and over time developed a "hand and glove" type of relationship which resulted into the weevil being a specialized feeder on banana (Baliddawa, 1985).

The higher feeding index on the susceptible cultivar mbidde (AAA) than a similarly susceptible cultivar lusumba (AAA) suggests that the weevils preferred one susceptible cultivar to another. However the feeding index of susceptible cultivar gonja (AAB) was higher than that of resistant cultivar soth (AAB), thus suggesting that the weevils preferred the susceptible cultivar to the resistant one. Furthermore, comparison of indices on

susceptible gonja (AAB) and susceptible mbidde (AAA) revealed no preference for either cultivar. Similarly, the weevils showed no preference for either of the controls (soth and mbidde) compared to the moderately resistant cultivar sukalindizi (AB).

After computing and ranking the preference ratios however, the results revealed highest preference ($P \leq 0.05$) for the moderately resistant cultivar sukalindizi and lowest for susceptible cultivar lusumba when compared to mbidde. Additionally, results of the experiment suggest that weevils preferred ($P \leq 0.05$) test cultivars that were mostly susceptible, including sukalindizi which is moderately so.

The long period (forty days) for which the insects were left in the experimental arena, and the substantial level of damage and consumption of more susceptible cultivars when tested against the resistant control, and lack of a clear cut choice when susceptible cultivars are tested against a susceptible check, indicate that the insects had adequate time to move about and select cultivars of their choice, and that they use some cues which are perceivable when they (weevils) are on the plant. In fact, a preliminary dual choice experiment carried out earlier using an inert material (stone), showed that weevils preferred the banana rhizomes regardless of their resistance or susceptibility status, and that the feeding indices were higher in the susceptible cultivars than the resistant cultivars (3.5 for mbidde, compared to 1 on soth).

5.5. BANANA RHIZOME NUTRITION STATUS

The observations that there were no significant differences ($P \leq 0.05$) in the nutritive content of various cultivars (Table 8 and Appendix 10), but the weevil numbers found on the rhizomes were significantly different ($P \leq 0.05$), that there was a correlation between nitrogen and weevil count (0.6701), that there was no significant ($P \leq 0.05$) difference between the cultivars for rhizome weight, and that there was no correlation between the nutritive contents, rhizome weight and weevil counts, suggests that the weevil population build-up on some cultivars (gonja, lusumba, mbidde, and nakyetengu all of which are susceptible) was not influenced by the nutritive contents of the host. This fact however does not apply for the resistant cultivar soth and the moderately resistant cultivar sukalindizi. Basing on the striking similarities in the nutritional requirements of a broad range of insect species Beck and Reese, (1979) postulated that the basic nutritional requirements of all plant feeding insects were virtually identical, so that any phytophagous insect could thrive on the tissue of any green plant. However, food habits and host plant specificity were said to be determined by the effects of a complex of non-nutritional allelochemicals which attract or repel insects and influence their locomotion, oviposition and feeding behaviour. In their work on banana semiochemicals, Ndiege *et al.*, (1991b) identified some terpenoid allelochemicals (mono and sesquiterpenes) furthermore terpenoids have been shown to have some influence on juvenile hormone activity (Beck and Reese, 1979).

The rhizome weight, which was used as a parameter to determine rhizome density or firmness, was not significantly different ($P \leq 0.05$) between the cultivars. and was not correlated to the number of weevils found on the cultivars. This is in conformity with earlier reports by Pavis and Minost (1993) and Rodomiro *et al.*, (1995) there was no correlation between rhizome hardness and weevil infestation rate, though resistant clones showed increased hardness in rhizomes.

5.6. CONCLUSIONS

After examining the results of this study, a few conclusions can be drawn on the type of mechanism of resistance employed by the banana plants against colonization by the banana weevil, *Cosmopolites sordidus*.

- 5.6.1. It is justifiably conclusive from the results of the orientation and movement experiments that distant perceivable stimuli, especially plant volatiles, do not play a role in the selection process of the weevil for resistant or susceptible cultivars. The weevil responds to volatiles produced by the banana plant regardless of its resistant/susceptibility status.
- 5.6.2. It can also be concluded that the female weevils' selection of host for oviposition is to some degree influenced by the males, which tend to be stationary and produce the aggregation pheromone.

- 5.6.3. Furthermore, it can be concluded from the movement experiments that the weevil can settle on any banana cultivar regardless of the resistance/susceptible status of the plant and that some banana cultivars can tolerate the banana weevil attack. This is in consistence with Stover (1989)'s statement that, "A weevil-free plantation is a fantasy; a viable well-managed plantation can still operate profitably with a certain level of borer infestation."
- 5.6.4. It is further conclusive from the preference/non-preference and rhizome nutrition results that damage of banana plants by weevils is much more severe in the susceptible than the resistant cultivars. Furthermore, female weevils prefer susceptible to resistant cultivars for oviposition, a fact which is probably influenced by secondary metabolites (especially feeding stimulants) that are possibly produced in larger quantities by the susceptible than by resistant cultivars.
- 5.6.5. Finally it is conclusive from the current studies that antibiosis has a role in the infestation of bananas by the banana weevil as suggested elsewhere (Viswanath, 1981; Mesquita et al., 1984; Uronu, 1992 and Seshu Reddy et al., 1993), that there is an interaction of the three mechanisms of resistance (non-preference, antibiosis and tolerance) being used by the banana plant to resist infestation and colonization by the banana weevil and that banana cultivars are not really resistant to the weevil, but rather tolerant with varying degrees of susceptibility.

5.7. RECOMMENDATIONS

- 5.7.1. Farmers should be encouraged to use split pseudostems (preferably from known susceptible cultivars) as traps to reduce the weevil populations in their banana plantations.
- 6.7.2. Further research on the role of semiochemicals in the colonization process of the banana plant by the weevil must be carried out so that these could be used as baits in traps.
- 5.7.3. Studies to relate weevil trap catches to rhizome damage and yield, and thus determine economic threshold and economic injury level should to be undertaken.

CHAPTER 6

REFERENCES

- Afreh-Nuamah, K. 1993. Laboratory rearing of the plantain stem borer (*Cosmopolites sordidus*). *Musafrica*. 1(3): 2-3.
- Ambrose, E. 1984. Research and development in banana crop protection (excluding sigatoka) in the English speaking Caribbean. *Fruits* 39(4): 234-247.
- Anon. 1964. Banana production in the Luapula Province and prospects for their marketing on the line of rail. Ministry of Agriculture Publication, Lusaka, Zambia.
- Anon. 1968. Commonwealth Institute of Entomology. 1968 Distribution Maps of Insect Pest *Cosmopolites sordidus* (Germar). Series A Map 41 (Revised).
- Anon. 1969. Beetle borer studies. *Banana Bull.* 30(7): 4
- Bakyalire, R. and Ogenga-Latigo, M. W. 1993. Aspects of the life cycle and behaviour of the banana weevil, *Cosmopolites sordidus* Germar. to be published in *Journal for East African Agric.*
- Baliddawa, C. W. 1985. Insect behaviour and host plant resistance. *Insect Sci. Appl.* 6(3): 337-340.
- Barrett, E. O. 1928. *The Tropical Crops*. The MacMillan Company, New York.
- Beccari, F. 1967. Contributo alla conoscenza del *Cosmopolites sordidus* (Germar)(Coleoptera: Curculionidae). *Revista di Agricoltura Subtropicale e tropicale, Firenze*. 61 (4/6): 131-150.

- Beck, S. D. 1965.** Resistance of plants to insects. *Ann. Rev. Entomol.* 10: 207-232.
- Beck, S. D. and Reese, C. J. 1979.** Insect-plant interactions: Nutrition and metabolism. pp 41-92. in *Recent Advances in Phytochemistry Vol. 10. Biochemical Interaction Between Plants and Insects* (ed. Wallace, J. W. and Mansell, L. R.). Plenum Press, New York.
- Braithwaite, B. M. 1967.** Banana beetle borer control investigations on the north coast of New South Wales. *Agricultural Gazette of New South Wales.* 78: 359.
- Budenberg, W. J., Karago, F. W., and Ndiege, I. O. 1991.** Banana weevil semiochemicals. *ICIPE Annual Report, 1991.* 121-122pp.
- Burden, O. J. and Coursey, D. G. 1977.** Bananas as a food crop. in *Food of the Lowland Tropics* ed. Leakey, C. L. A. and Wills J. B. Oxford University Press, London.
- Cardenosa-Barriga, R. 1961.** Platqnos y bananos en Colombia. *Agric. Trop.* 17: 665-677.
- Cheeseman, E. E. 1948.** Classification of the bananas III. Critical notes on the species. *Kew Bull.* 2:145- 153.
- Commandeur, P. 1994.** The politics of banana and plantain research. *Biotechnology and Development Monitor.* No. 18.
- Ddungu, J. C. M. 1987.** Regional needs for banana and plantain improvement in eastern Africa. in *Banana and Plantain Breeding Strategies: Proceedings of an International Workshop held at Cairns, Australia 13-17 October, 1986.* (ed. Persley, G. J. and De Lange, E. A.). *ACIAR Proceedings* No. 21.
- de Jager, K. 1993.** Banana weevil borer. pp 119-120. in *Handbook of Banana Growing in South Africa* (ed. Robinson, J. C.). Institute for Tropical and Subtropical Crops.
- De Langhe, E. A. 1986.** A preliminary study of the needs for banana research in east Africa. INIBAP.
- FAO. 1990.** *FAO Production Year Book.* FAO, Rome.
- FAO. 1993.** *FAO Production Year Book.* FAO, Rome.
- Feakin, S. D. 1971.** *Pest Control in Banana.* Pans Man. London.
- Foreman, P. L. 1973.** Investigations into resistance of the banana weevil borer

- Cosmopolites sordidus* to dieldrin in Jamaica. Banana Board Ann. Report 1973.
- Franzman, B. A. 1972.** Banana weevil borer in North Queensland. *Queensl. Agric. Jour.* 319-321.
- Froggatt, J. L. 1925.** The banana weevil borer (*Cosmopolites sordidus* (Germar)). *Queensl. Agric. Journ.* 24: 558-593.
- Froggatt, J. L. 1926.** The banana weevil borer *Cosmopolites sordidus*. *Queensl. Agric. Livst. Div. Entomol. Plt. Pathol. Bull.* No. 4.
- Froggatt, J. L. 1928.** Baiting for banana weevil control. *Queensl. Agric. Journ.* 3(29): 282-283.
- Greenwell, P. J. 1944.** Origins of some east African Food plants. Part 1. *East Afric. Journ.* 2:34-39.
- Harris, W. V. 1947.** The banana borer. *The East African Agric. Journ.* 13: 15-18.
- Hill, D. 1983.** Crop Pests. Longmans.
- IITA. 1994.** Banana Research training Manual. Banana Research and technology Transfer Training Course. 26th June-16th July, 1994, Kampala. Uganda.
- INIBAP. 1986.** Banana Research in east Africa. Proposal for a regional research and development network.
- INIBAP. 1987.** INIBAP Introduction Brochure. Montpellier, France.
- Ittyepe, K. 1986.** Studies on host preference of banana weevil borer, *Cosmopolites sordidus* Germ. (Coleoptera: Curculionidae). *Fruits.* 41(6): 375- 379.
- Jackai, L. E. N. 1991.** Laboratory and screen house assays for evaluating cowpea resistance to the legume pod borer. *Crop Protection.* 10: 48-52.
- Karikari, S. K. 1973.** Some taxonomic assessment of the contribution of *Musa acuminata* and *Musa balbisiana* to the origins of plantain and banana in Ghana. *Ghana Journ. Agric. Soc.* 6: 9-19.
- Kogan, M. and Goeden, R. D. 1970.** The host range of *Lema Trilineata daturaphila* (Coleoptera: Chrysomelidae). *Ann. Entomol. Soc. Am.* 53: 1175-1180.
- Kogan, M. and Ortman, E. F. 1978.** Antixenosis - A new term to define Painter's "Non-

- preference" modality of resistance. *Bull. Entomol. Soc. Am.* 24(2): 175-176.
- Koppenhofer, A. M., Seshu Reddy, K. V., Madel, G., and Lubega, M. C. 1991.** Predators of the banana weevil, *Cosmopolites sordidus* (Germar)(Coleoptera: Cucurlionidae) in western Kenya. *Journ. Appl. Entomol.* 114: 530-533.
- Lara, E. F. 1966.** The banana stalk borer *Castniomera humboldti* (boisduval) in da Estrella Valley, Costa Rica. *V. Cultural Control turrialba.* 16(2):136-138.
- Liceras, L., Urrelo, G. R., and Beltran, F. S. 1973.** Test for the control of banana weevil, *Cosmopolites sordidus* Germar (Coleoptera: Curculionidae) at the time of planting. *Revista Peruana de Entomologia.* 16(1): 50-54
- Longoria, A. 1968.** Diferencia sexuales en la morfologia externa de *Cosmopolites sordidus* Germar (Coleoptera: Curculionidae). *Ciencias Bio. la Habana.* 1: 1-11.
- Martinez, M. D. L., Gonzalez, A., and Longoria, G. 1990.** Oviposicion y dessorollo de *Cosmopolites sordidus* (Coleoptera: Curculionid ae) en plantano y malanga. *Ciencias de la Agricultura.* 40:169-171.
- Masefield, G. B. 1944.** Some recent observations on plantain crop in Baganda. *East Afric. Agric. Journ.* 12-17.
- McNutt, D. N. 1974.** A review of banana weevil control in Uganda, with further tests of Dieldrin formulation. *East African and Forestry Journ.* 205-209.
- Mesquita, A. L. M., Alves, E. J., and Caldas, R. C. 1984.** Resistance of banana cultivars to *Cosmopolites sordidus* (Germar 1824). *Fruits.* 39(4): 254-257.
- Mitchell, G. A. 1978.** Banana entomology in the Windward Islands. Final Report, 1974-1978. Centre for Overseas Pest Research, London.
- Moznette, G. F. 1920.** Banana root-borer. *Journ. Agric. Res. Washington D.C.* 19(1): 39-56.
- Ndiege, I. O., Budenberg, W.J., Lwande, W., and Hassanali, A. 1990.** Airborne volatiles from banana pseudostem and rhizome as attractants for the banana weevil *Cosmopolites sordidus*. Eighteenth Ann. Report, ICIPE. pp 111-112.
- Ndiege, I. O., Budenberg, W. J., Karago, F. W., Otieno, D. O., Harrison, B., and Hassanali, A. 1991a.** Semiochemical studies on the banana weevil. Nineteenth Ann. Report, ICIPE. pp 99-101.

- Ndiege, I. O., Budenberg, W. J., Lwande, W., and Hassanali, A. 1991b.** Volatile components of banana pseudostem of a cultivar susceptible to the banana weevil. *Phytochemistry*. 30(12): 3929-3930.
- Neal, M. C. 1965.** In the Gardens of Hawaii. Bernice P. Bishop Museum Special Publication. Bishop Museum Press.
- Neuenschwander, P. 1988.** Prospects and proposals for biological control of *Cosmopolites sordidus* in Africa. pp 54-57. in Nematodes and Borer weevil in Bananas. Proceedings of a Workshop held in Bujumbura, Burundi 7-11 December, 1987. INIBAP.
- Now Magazine, 1991.** Sunday Nation Newspaper, Nairobi.
- Nsemwa, L. T. H. 1991.** Problems of banana weevil and nematodes in the southern highlands of Tanzania. *Fruits*. 46(5): 541-542.
- Ostmark, H. E. 1974.** Economic insect pests of banana. *ARE* 19: 161-176.
- Painter, R. H. 1951.** Insect Resistance in Crop Plants. The MacMillan Company, New York.
- Pavis, C. and Minost, C. 1993.** Banana resistance to the banana weevil borer *Cosmopolites sordidus* Germar (Coleoptera: Curculionidae): role of pseudostem attractivity and physical properties of the rhizome. pp 129-142. in Breeding Banana and Plantain for Resistance to Disease and Pests (ed. Garry, J.). CIRAD/INIBAP.
- Pinese, B. 1989.** Controlling banana weevil borer. *Banana Bulletin*. 53(1):6-8.
- Pinto, M. P. D. 1928.** The two weevil pests of plantains (*Musa sapientum* L.) *Cosmopolites sordidus* (Germar) and *Odoiporus longicornis* (oliv.). *Trop. Agric. Mag. Ceylon Agric.* 70: 216-224.
- Prasad, J. S. and Seshu Reddy, K. V. 1994.** Hot water treatment for banana planting material made easy. *Infomusa*. 3(2):16
- Rajamony, L., George, K. C., Anitta, N., and Radhakrishna, T. C. 1993.** Stability and adaptation of banana clones belong to AAA group. *The Planter*. 69: 343-353.
- Roberts, F. S. 1955.** The banana root borer (*Cosmopolites sordidus* Germar), la Lima. United Fruit Company (Circular, 29), 11pp

- Rodomiro, o., Vuylsteke, D., Dumpe, B., and Ferris R. S. B. 1995.** Banana weevil resistance and corm hardness in *Musa*. (In Press).
- Roth, L. M. and Wills, E. R. 1963.** The humidity behaviour of *Cosmopolites sordidus* (Coleoptera:Curculionidae). *Ann. Entomo. Soc. Am.* 56:41-52.
- Saxena, K. N. 1969.** Pattern of insect-plant relationship determining susceptibility or resistance of different plants to an insect. *Ent. Exp. Appl.* 12: 751-766.
- Saxena, K. N. 1984.** Bases of resistance or susceptibility to insects. 12th Ann. Report, ICIPE. pp 12.
- Saxena, K. N. 1985.** Behavioural basis of plant resistance or susceptibility to insects. *Insect Sci. Appl.* 6(3): 303-313.
- Saxena, K. N., Ghandhi, J. R., and Saxena, R. C. 1974.** Patterns of relationship between certain leafhoppers and plants. *Ent. Exp. Appl.* 17: 303-318.
- Schillinger, J. S. and Gallun, R. L. 1968.** Leaf pubescence of wheat as a deterrent to the cereal leaf beetle *Oulenia melanopus*. *Ann. Entom. Soc. Amer.* 61: 900-903
- Sen, A. C. and Prasad, D. 1952.** Pests of banana in Bihar. *Indian Journ. Entomol.* 15: 240-246.
- Seshu Reddy, K. V. 1987.** Some biological observations on the banana weevil in western Kenya. pp 86. in *Proceedings of the International Symposium on Nematodes and the Borer in Bananas: Present Status and Outlook.* 7-11 December, 1987. Bujumbura, Burundi. INIBAP.
- Seshu Reddy, K. V., and Lubega, M. C. 1993.** Evaluation of banana cultivars for resistance to / tolerance of the banana weevil *Cosmopolites sordidus* Germar. pp 143-148. in *Breeding Banana and Plantain for Resistance to Disease and Pests.* (ed. Ganry, J.). INIBAP.
- Seshu Reddy, K. V., Prasad, J. S., and Sikora, R. A. 1994.** Bio-intensive management of crop borers of banana. Paper presented at the Third International Conference on Tropical Entomology 30.10.94 - 4.11.94, Nairobi, Kenya.
- Simmonds, N. W. 1928.** Some experiments to ascertain the part played by flight in the dispersal of the banana borer *Cosmopolites sordidus* in Fiji. *Agric. Journ. Dept. Agric. Fiji.* 1(3).

- Simmonds, N. W. 1966.** Bananas (2nd ed.). Longmans, London.
- Simmonds, N. W. 1967.** Bananas. Longmans, London.
- Simmonds, N. W. 1986.** Classification and breeding bananas. Banana and Plantain Breeding Strategies. ACIAR Proc. 21: 69-73.
- Simmonds, N. W. and Weatherup, S. T. C. 1990.** Numerical taxonomy of the cultivated bananas. *Trop. Agric. (Trinidad)*. 67(1): 90-92.
- Singh, D. P. 1986.** Breeding for Resistance to Disease and Insect Pests. Springer Verlag, London.
- Speijer, P. R., Budenberg, W. J., and Sikora, R. 1993.** Relationship between nematodes, weevils, banana and plantain cultivars and damage. *Ann. Appl. Biol.* 123: 517-525.
- Stover, R. H. 1989.** Banana weevil borer. *Banana Growers Federation Bulletin (Aust.)*: 53(9): 15-19.
- Stover, R. H., and Simmonds, N. W. 1987.** Bananas. Longmans, London.
- Tang, C. Y. and Hwang, S. C. 1994.** Current breeding work on *Musa*. pp 44-45. in Banana and Plantain Breeding: Priorities and Strategies. Proceedings of the First Meeting of the *Musa* Breeder's Network held in La Lima, Honduras, 2-3 May, 1994. INIBAP, Montpellier, France.
- Treverrow, N., Peasley, D., and Ireland, G. 1992.** Banana Weevil Borer. A pest management handbook for banana growers. NSW. Agriculture.
- Uronu, B. E. M. A. 1992.** The effects of plant resistance and cultural practices on the population densities of banana weevil *Cosmopolites sordidus* (Germar) on banana yield. Ph. D. Thesis. Kenyatta University, Nairobi, Kenya.
- Uzakah, R. P. 1991.** Ovarian development of the banana weevil *Cosmopolites sordidus*. ICIPE Annual Report, 1991. pp 122.
- Vilardebo, A. 1973.** Coefficient of infestation. Criteria of assessment of intensity of attack by the banana black weevil *Cosmopolites sordidus* (Germar). *Fruits*. 28(6): 417-426.
- Viswanath, B. N. 1981.** Development of *Cosmopolites sordidus* (Coleoptera: Curculionidae) on banana varieties in south India. *Colemania*. 1(1): 57-58.

- Walangululu, M., Litucha, B. M. and Musasa, M. 1993.** Potential for the control of the banana weevil *Cosmopolites sordidus* Gemar with plants reputed to have insecticidal effect. *Infomusa*. 2(1): 9.
- Wallace, C. R. 1937.** The banana beetle borer. Investigation and control measures. *Agric. Gazette New South Wales*. 48: 621-638.
- Wallace, C. R. 1938.** Unpoisoned baits for reducing populations of banana beetle (*Cosmopolites sordidus*). *Journ. Aust. Inst. Agric. Sci.* 4: 157-160.
- Wardlaw, C. W. 1972.** Banana Diseases including Plantain and Abaca. 2nd Edition. Longmans, London.
- Wiseman, B. R., Davis, F. M., and Williams, W. P. 1983.** Fall armyworm: Larval density and movement as an indication of nonpreference in resistant corn. *Protection Ecology*. 5: 135-141
- Wolcott, G. N. 1930.** The initiation of entomology extension in Haiti. *Journ. Econ. Entom.* 24: 131-141.
- Yaringano, C. V. M. and Meer, F Van den. 1975.** Control of the banana weevil, *Cosmopolites sordidus* by various traps and granulated pesticides. *Revista Peruana de Entomologia Agricola*. 18(1):112-116.
- Zimmerman, E. C. 1968a.** The *Cosmopolites* banana weevils (Coleoptera: Curculionidae: Rhynchophorinae). *Pacific Insects*. 10(2): 295-299.
- Zimmerman, E. C. 1968b.** Rhynchophorinae of south eastern Polynesia. *Pacific Insects*. 10(1): 47-77.

APPENDIX 1.

INSECT BORERS OF BANANA, PLANT PART ATTACKED AND THEIR DISTRIBUTION*

NAME OF BORER	PART ATTACKED	DISTRIBUTION
ORDER: COLEOPTERA		
FAMILY: CURCULIONIDAE		
1. <i>Cosmopolites sordidus</i> (Germar)	Rhizome pseudostem	worldwide
2. <i>C. pruinosis</i> Heller	Rhizome pseudostem	Philippines, Hawaii, Borneo
3. <i>Metamasius ensirostris</i>	Pseudostem	South America
4. <i>M. hemipterus</i> Linnaeus	Pseudostem	West Indies, West Africa
5. <i>M. inaequalis</i>	Pseudostem	South America
6. <i>M. sericeus</i>	Pseudostem	Africa
7. <i>Odoiporus longicollis</i> Oliv.	Pseudostem	Pacific Islands, Asia
8. <i>Polytus mellerborgii</i>	Pseudostem	China
9. <i>Temnoschoita basipennis</i> Duvivier	Pseudostem	Uganda
10. <i>T. delumbrata</i> Bohman	Pseudostem	Tanzania
11. <i>T. erudita</i> Duvivier	Pseudostem	Uganda
12. <i>T. nigroplagiata</i> Qued	Pseudostem	Uganda, Congo, Kenya

- | | | |
|---|------------|-----------------------------|
| 13. <i>T. quadripustulata</i>
Fabricius | Pseudostem | Sao Tome, Ghana,
Dahomey |
| 14. <i>Rhynchophorus palmarum</i>
Linnaeus | Rhizome | Columbia |
| 15. <i>Philicoptus iliganus</i> | Root | Philippines |

FAMILY: SCARABAEIDAE

- | | | |
|---------------------------------|------------|----------------------|
| 16. <i>Heteronychus cladius</i> | Pseudostem | Papua New Guinea |
| 17. <i>Ligyris ebenus</i> | Root | West Indies |
| 18. <i>Phyllophaga pleei</i> | Pseudostem | Caribbean, Guadelope |

ORDER: DIPTERA

FAMILY: CHLOROPIDAE

- | | | |
|--------------------------|------------|-------|
| 19. <i>Assurania</i> sp. | Pseudostem | India |
|--------------------------|------------|-------|

FAMILY: TRYPETIDAE

- | | | |
|------------------------------------|-------|-----------|
| 20. <i>Dacus musae</i>
Tryon | Fruit | Australia |
| 21. <i>D. curvipennis</i>
Frogg | Fruit | Fiji |

ORDER: LEPIDOPTERA

FAMILY: TINEIDAE

- | | | |
|--------------------------------------|---------------------|-------------------------|
| 22. <i>Opogona sacchari</i>
Bojer | Fruit
pseudostem | Tropics,
Sub tropics |
| 23. <i>O. subcervinella</i> | Fruit | Canary Islands |

FAMILY: CASTNIIDAE

- | | | |
|---------------------------------------|------------|------------------------------|
| 24. <i>Castina licus</i>
Fabricius | Pseudostem | Central and South
America |
|---------------------------------------|------------|------------------------------|

25. *Castniomera humboldti*
Basduwal

Rhizome
pseudostem

South America

FAMILY: LYONETIDAE

26. *Hieroxestis subcervinella*
Meyr

Fruit

Canary Islands,
Sechelles,
Mauritus, St. Helena

FAMILY: NOCTUIDAE

27. *Plusia chalcytes*
Esp.

Fruit

Africa

28. *Tiracola plagiata*
Walk.

Fruit

Australia

* Source: Seshu Reddy et al., 1994.

APPENDIX 2.

BANANA PRODUCTION IN THE WORLD (1992)

REGION	TOTAL PRODUCTION (1000 MT)	PERCENTAGE COOKING BANANA
World	78498	36
Africa	27591	75
Asia	20786	4
Europe	410	0
Oceania	1528	0
North/Central America	9555	16
South America	18627	27
Australia	200	0

Source: FAO Production Year Book, 1993.

APPENDIX 3.

BANANA PRODUCTION IN EASTERN AFRICA (1992)

REGION	TOTAL PRODUCTION (1000 MT)	PERCENTAGE OF COOKING BANANA
Africa	27591	75
Burundi	1585	100
Kenya	580	62
Rwanda	2700	100
Tanzania	1600	50
Uganda	9058	94
Zaire	2697	85

Source: FAO Production Year Book, 1993.

APPENDIX 4.

BANANA CULTIVAR CHARACTERIZATION

CULTIVAR:.....

AGE (Months after planting):.....

PLANT No:.....

VEGETATIVE CHARACTERS:

- | | |
|----------------------------|---|
| 1. Leaf orientation | erect, intermediate, drooping |
| 2. Leaf colour | green, green with red |
| 3. Leaf margin | smooth, crenated |
| 4. Lamina shape | elongated, intermediate, broad |
| 5. Petiole clasping | yes, no |
| 6. Petiole colour | green, red, other |
| 7. Suckering | inhibited, 1 or 2 sucker not inhibited, many suckers growing freely |
| 8. Sucker orientation | erect, intermediate, divergent |
| 9. Colour of pseudostem | green, yellow, green-yellow, red |
| 10. Pseudostem blotches | none, slight, moderate, extensive |
| 11. Colour of blotches | brown, black |
| 12. Waxiness of pseudostem | None, slight, moderate, heavy |

INFLORESCENCE CHARACTERS:

- | | |
|--------------------------|--|
| 1. Peduncle hairiness | glabrous, finely hairy,
coarsely hairy |
| 2. Angle of female axis | erect, horizontal,
subhorizontal, pendulous |
| 3. Angle of male axis | erect, horizontal,
subhorizontal, pendulous |
| 4. Male bud present | yes, no |
| 5. Bunch | lax, dense |
| 6. colour immature fruit | green, yellow, grey-blue |
| 7. Fruit apex | blunt, bottlenecked |
| 8. Fruit cross-section | rounded, angular |
| 9. Fruit parthenocapy | yes, no |

FRUIT CHARACTERS:

- | | |
|---------------------------|---|
| 1. Seeds | yes, no |
| 2. Taste | sweet-aromatic, sweet-acid,
starchy-acid |
| 3. Colour ripe fruit peel | green, yellow, golden, red,
brown, other |
| 4. Colour ripe fruit pulp | creamy, yellow, orange-yellow,
other |

MALE FLOWER CHARACTERS:

- | | |
|--------------------------------|----------------------|
| 1. Compound tepal colour | yellow, orange-white |
| 2. Compound tepal purple tinge | yes, no |
| 3. Ovary colour | white, other |

- | | |
|---------------------------------|---|
| 4. Stigma colour | orange-yellow, green-yellow, white-yellow, |
| 5. Style purple tinge | yes, no |
| 6. Staminode purple tinge | yes, no |
| 7. Free tepal transparent | yes, no |
| 8. Free tepal corrugated | yes, no |
| 9. Pollen | yes, no |
| 10. Bract scars on male axis | prominent, intermediate, not prominent |
| 11. Male bud imbrication | convolute, imbricated |
| 12. Bract waxiness | yes, no |
| 13. Male bract | deciduous, persistent |
| 14. Male bract apex | acute, intermediate, obtuse |
| 15. Male bracts internal colour | fading, bright crimson, yellow to bronze, other |
| 16. Male bract external colour | green to yellow, red to purple, brown-bronze, other |

APPENDIX 5.

ANOVA ON BANANA WEEVIL ORIENTATION TOWARDS DIFFERENT BANANA PLANT PARTS

SOURCE	DF	SS	MS	F	Pr>F
Treatment	2	990.11	495.06	4.62	0.027*
Error	15	1607.01	107.13		
Total	17	2597.11			

CV: 32.12% *= $P \leq 0.05$

APPENDIX 6.

ANOVA ON BANANA WEEVIL ORIENTATION/ARREST TOWARDS DIFFERENT BANANA CULTIVARS (LAB. EXPERIMENT)

SOURCE	DF	SS	MS	F	Pr>F
Treatment	5	809.14	161.83	4.06	0.0062**
Error	30	1195.833	39.86		
Total	35	2004.97			

CV: 38.33% **= $P \leq 0.01$

APPENDIX 7.

BANANA WEEVIL MOVEMENT BETWEEN BANANA CULTIVARS

TOTAL WEEVIL COUNT

CUL	WEEVILS RECORDED 24 HOURS AFTER RELEASE				LSD
	MOVED AND ARRESTED		RETAINED		
	2 METRES	4 METRES	(SOTH)		
	MEAN \pm S.E.	MEAN \pm S.E.	MEAN \pm S.E.		
Gon	14.00 \pm 3.70b	7.50 \pm 2.75c	27.75 \pm 5.84a		8.33
Lus	25.25 \pm 1.93a	17.50 \pm 8.39a	15.25 \pm 5.98a		25.32
Mbi	22.50 \pm 6.29a	12.00 \pm 2.35ab	7.29 \pm 2.90b		15.08
Nak	13.75 \pm 4.48a	9.25 \pm 1.49a	9.19 \pm 3.19a		11.58
Suk	10.67 \pm 3.48a	11.00 \pm 2.65a	11.33 \pm 2.67a		12.55
Sot	12.50 \pm 4.44a	10.25 \pm 2.81a	13.75 \pm 2.66a		10.43

LEGEND:

CUL = Cultivar, Gon = Gonja, Lus = Lusumba, Mbi = Mbidde,
 Nak = Nakyatengu, Suk = Sukalindizi, Sot = Soth

Differences between means in the same row followed by the same letter are not significantly different ($P \leq 0.05$); LSD test on square root transformed data.

APPENDIX 8.

BANANA WEEVIL MOVEMENT BETWEEN BANANA CULTIVARS

MALE WEEVIL COUNT

CUL	WEEVILS RECORDED 24 HOURS AFTER RELEASE			LSD
	MOVED AND ARRESTED		RETAINED	
	2 METRES	4 METRES	(SOTH)	
	MEAN \pm S.E.	MEAN \pm S.E.	MEAN \pm S.E.	
Gon	12.50 \pm 2.22b	7.50 \pm 2.63c	25.50 \pm 5.56a	7.56
Lus	12.00 \pm 0.71a	8.50 \pm 4.21a	7.00 \pm 2.35a	11.74
bi	18.00 \pm 4.83a	11.00 \pm 1.29ab	7.50 \pm 3.4b	13.95
Nak	15.50 \pm 5.12a	6.00 \pm 2.16a	10.50 \pm 4.27a	13.95
Suk	11.33 \pm 5.33a	12.00 \pm 4.00a	7.33 \pm 2.91a	12.64
Sot	11.00 \pm 5.20a	10.00 \pm 3.56a	13.00 \pm 1.91a	9.51

LEGEND:

CUL = Cultivar, Gon = Gonja, Lus = Lusumba, Mbi = Mbidde,
 Nak = Nakyetengu, Suk = Sukalindizi, Sot = Soth

Differences between means in the same row followed by the same letter are not significantly different ($P \leq 0.05$); LSD test on square root transformed data.

APPENDIX 9.

BANANA WEEVIL MOVEMENT BETWEEN BANANA CULTIVARS

FEMALE WEEVIL COUNT

CUL	WEEVILS RECORDED 24 HOURS AFTER RELEASE			LSD
	MOVED AND ARRESTED		RETAINED	
	2 METRES	4 METRES	(SOTH)	
	MEAN \pm S.E.	MEAN \pm S.E.	MEAN \pm S.E.	
Gon	15.50 \pm 5.68b	8.00 \pm 2.94b	30.00 \pm 6.19a	11.29
Lus	12.00 \pm 2.48a	9.00 \pm 4.32a	5.00 \pm 2.48a	13.50
bi	27.00 \pm 8.35a	13.00 \pm 3.70a	7.50 \pm 2.50a	21.04
Nak	12.00 \pm 4.24a	12.00 \pm 2.83a	7.50 \pm 3.30a	11.46
Suk	10.00 \pm 3.01a	10.00 \pm 3.46a	15.33 \pm 2.91a	13.43
Sot	14.00 \pm 3.74a	10.50 \pm 2.50a	17.50 \pm 5.01a	11.02

LEGEND:

CUL = Cultivar, Gon = Gonja, Lus = Lusumba, Mbi = Mbidde,
 Nak = Nakyatengu, Suk = Sukalindizi, Sot = Soth

Differences between means in the same row followed by the same letter are not significantly different ($P \leq 0.05$); LSD test on square root transformed data.