

# Microorganism-mediated behaviour of malaria mosquitoes

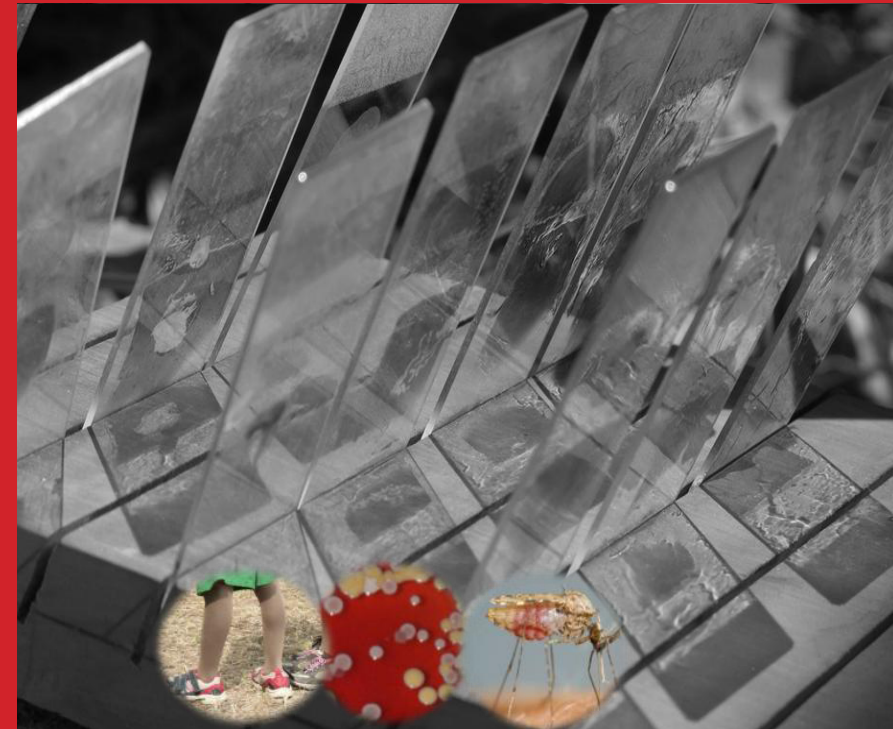

**Annette O. Busula**

Microorganism-mediated behaviour of malaria mosquitoes

Annette O. Busula

# Microorganism-mediated behaviour of malaria mosquitoes

Annette Obukosia Busula

## **Thesis committee**

### **Promotor**

Prof. Dr Willem Takken

Personal chair at the Laboratory of Entomology

Wageningen University & Research

### **Co-promotor**

Dr Jetske de Boer

Researcher, Laboratory of Entomology

Wageningen University & Research

### **Other members**

Prof. Dr Hauke Smidt, Wageningen University & Research

Prof. Dr Geert Wiegertjes, Wageningen University & Research

Dr Michelle van Vugt, University of Amsterdam

Prof. Dr Bregje Wertheim, University of Groningen

This research was conducted under the auspices of the Graduate School of Production Ecology and Resource Conservation

Annette O. Busula

Microorganism-mediated behaviour of malaria mosquitoes

**Thesis**

submitted in fulfilment of the requirements for the degree of doctor

at Wageningen University

by the authority of the Rector Magnificus

Prof. Dr A. P.J. Mol,

in the presence of the

Thesis Committee appointed by the Academic Board

to be defended in public

on Wednesday 17 May 2017

at 11 a.m. in the Aula.

Annette O. Busula

**Microorganism-mediated behaviour of malaria mosquitoes**

199 pages

PhD thesis, Wageningen University, Wageningen, the Netherlands (2017)

With references, with summary in English

ISBN 978-94-6343-115-6

DOI: <http://dx.doi.org/10.18174/407874>

To Benn Shihugwa's family, Maxwell, David, Bilhah, Isaac,  
Solomon and the future generations.



## TABLE OF CONTENTS

Abstract	8
Chapter 1 General introduction	9
Chapter 2 Mosquito host preferences affect their response to synthetic and natural odour blends	23
Chapter 3 Variation in host preference of malaria mosquitoes is mediated by skin bacterial volatiles	55
Chapter 4 Mechanisms of vertebrate-host manipulation by malaria parasites	77
Chapter 5 Gametocytaemia increases attractiveness of <i>Plasmodium falciparum</i> -infected Kenyan children to <i>Anopheles gambiae</i> mosquitoes	105
Chapter 6 Mechanisms of manipulation of human attractiveness by <i>Plasmodium</i> parasites	137
Chapter 7 General discussion	159
Summary	185
Acknowledgements	191
Curriculum vitae	195
List of publications	196
PE&RC PhD Education Certificate	197



## Abstract

Host-seeking is an important component of mosquito vectorial capacity on which the success of the other behavioural determinants depends. Blood-seeking mosquitoes are mainly guided by chemical cues released by their blood hosts. This thesis describes results of a study that determined the effect of microorganisms – host skin bacteria as well as malaria parasites – on host-seeking behaviour of female *Anopheles gambiae sensu stricto* and *An. arabiensis* in Homabay county, western Kenya. Semi-field and field experiments were conducted to determine the response of mosquitoes with different host preference to synthetic and natural odour blends from three vertebrate hosts, a human, a cow and a chicken. Screen house experiments were conducted to test whether specific skin bacteria or a mix of skin bacterial volatiles from the three vertebrate hosts mediate mosquito response. A review chapter in this thesis discusses how malaria parasites can manipulate human hosts to enhance their own transmission, by making the hosts more attractive to mosquitoes. Another experiment, using a dual-choice olfactometer, determined whether infection with malaria parasites increases human attractiveness to malaria mosquitoes, and whether the attractiveness of infected humans is *Plasmodium falciparum*-stage specific. Here, the same children participated in the study during infection with malaria parasites and after treatment with antimalarial drugs, artemisinin lumefantrine. Cage assays were further used to test mechanisms of attractiveness of *P. falciparum*-infected individuals using body odours or skin bacterial volatiles collected from the children at the two time points. Overall results show that skin bacterial volatiles play an important role in guiding mosquitoes with different host preferences to their specific host. For *An. gambiae s.s.*, high (microscopic) densities of *P. falciparum* gametocytes (and not parasite-free, submicroscopic gametocytes or asexual stages of *Plasmodium* parasites) results into higher attractiveness of hosts, and body odours play a role in attractiveness of *P. falciparum*-infected humans. The results may help to develop more effective health policies and enable targeted interventions towards the most attractive hosts, which could contribute to reductions in malaria transmission. Identification of general or common attractive volatiles produced by the natural hosts as well as those from the gametocyte carriers may contribute to the development of an improved synthetic odour blend that may be used for sampling of mosquitoes with different host preferences. The use of powerful odorants may result in reductions of vector-borne diseases transmitted by mosquitoes.

## **Chapter 1**

### **General introduction**



## Introduction

Vector-borne pathogens are transmitted by the bites of infected arthropod species. These pathogens require two different host species to complete their lifecycle, usually a vertebrate and an invertebrate host, of which the latter transmits the pathogen between vertebrate hosts (Killeen & Smith, 2007). Blood-feeding mosquitoes are important vectors of several human pathogens, including arboviruses namely: chikungunya, dengue fever, Rift Valley fever, yellow fever and Zika transmitted by *Aedes* mosquitoes amongst others. Japanese encephalitis, lymphatic filariasis and West Nile fever are transmitted by *Culex* mosquitoes, while *Anopheles* mosquitoes mainly transmit malaria. The contact rate between vectors and their vertebrate hosts affects the intensity of pathogen transmission, and hence disease epidemiology. The ability of vectors to locate their blood hosts therefore is crucial in disease maintenance and perseverance. Host odour is known to play an important role in mosquito host-seeking behaviour (Takken, 1991) and hence influences the contact rate between vectors and hosts. This thesis focuses on interactions between mosquitoes, malaria parasites, humans, and how skin bacterial volatiles mediate host-seeking behaviour of mosquitoes.

## Malaria

Malaria is a major vector-borne disease, caused by protozoan *Plasmodium* parasites (Kimani *et al.*, 2006; Alonso *et al.*, 2011; WHO, 2015b). Transmission of the parasites to humans is through bites of infected female *Anopheles* mosquitoes. In 2015, approximately 214 million malaria cases and 438,000 deaths occurred worldwide with children under five years and pregnant women being most vulnerable (WHO, 2015b). Malaria, the leading cause of morbidity and mortality in Sub-Saharan Africa (RBM, 2013) is estimated to cost USD 12 billion every year, absorbing to a maximum of 40% of the health expenses in Sub-Saharan countries (RBM, 2013).

### *Life-cycle*

Malaria parasite species that infect humans are *Plasmodium falciparum*, *P. vivax*, *P. malariae*, *P. ovale* and *P. knowlesi* (White *et al.*, 2014). Females of the *Anopheles gambiae* sensu lato sibling species complex (*An. gambiae sensu stricto* [hereafter termed *An. gambiae*] and *An. arabiensis*) and *An. funestus* are the principal vectors of malaria in most African countries (Coetzee, 2004; Okara *et al.*, 2010), while a higher diversity of vector species

occurs in other parts of the world (Sinka *et al.*, 2012). Dominance of African malaria vectors is largely due to their preference for human blood, high vector competence and high daily survival rates. The malaria transmission cycle starts when an infected female mosquito injects sporozoites into a human host while blood-feeding (figure 1). The sporozoites travel to the liver where they produce merozoites, which, in turn, infect red blood cells (*P. falciparum* does not have hypnozoites, a dormant liver stage). Inside the red blood cells, the parasite reproduces asexually until the cells burst, causing fevers and other symptoms of malaria. Eventually, some parasites develop into gametocytes that may be taken up by another mosquito while ingesting a blood meal. Inside the mosquito's midgut, the parasite reproduces sexually, producing sporozoites that migrate to the salivary glands, thereby closing the cycle (White *et al.*, 2014).

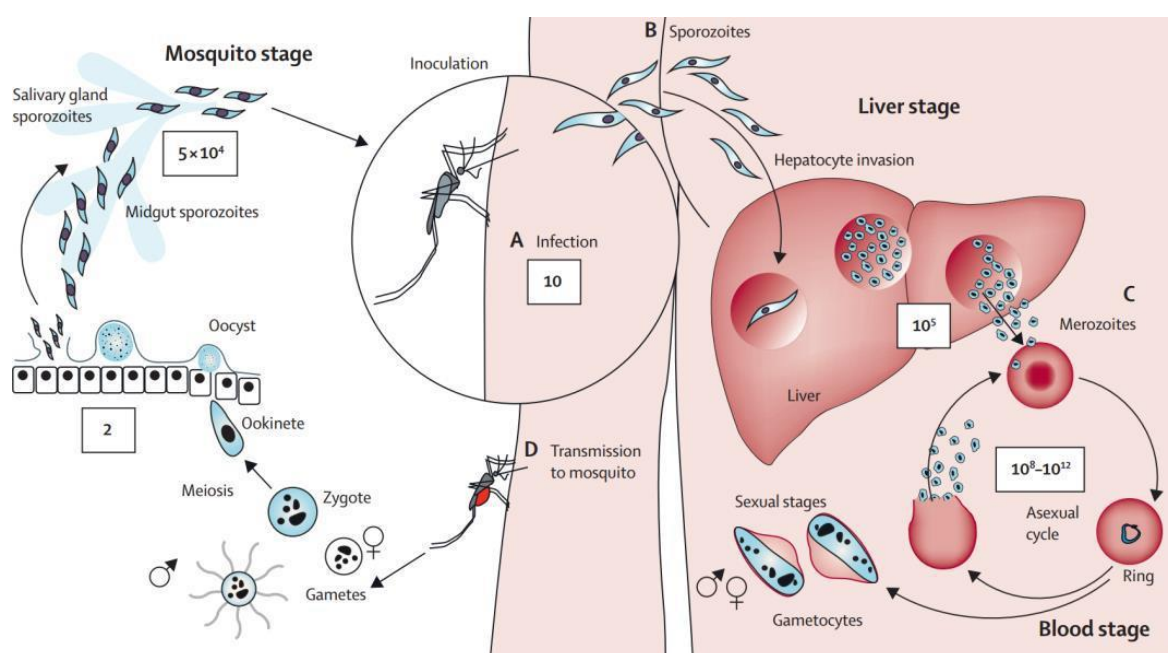

Figure 1. Life cycle of the malaria parasite *Plasmodium falciparum*. Infected female *Anopheles* mosquitoes pass *Plasmodium* sporozoites to a human who gets infected (A), while male and female gametocytes are the stages taken up by female mosquitoes from the blood stream of infected hosts in order to mediate disease transmission (D). Source: (White *et al.*, 2014).

Diagnostic tools to identify malaria infection include microscopic analysis of blood films, rapid diagnostic tests (RDTs) (Batwala *et al.*, 2010), real-time quantitative polymerase chain reaction (qPCR) (Hermsen *et al.*, 2001) and the quantitative nucleic acid sequence-based

amplification (QT-NASBA) that allows highly sensitive stage-specific quantification of malaria parasites (Schneider *et al.*, 2004; Bousema *et al.*, 2006). Treatment of malaria in all endemic countries in the world is mainly by artemisinin-lumefantrine, which kills all stages of malaria parasites (WHO, 2015b; Gonçalves *et al.*, 2016).

### **Mosquito host-seeking behaviour**

Mosquitoes use (volatile) chemical cues to locate their blood-meal hosts. They have a highly developed chemosensory system located on the antennae and maxillary palps (McIver, 1982; Zwiebel & Takken, 2004). These cues are more important to vectors that have a specific host requirement (Takken & Knols, 1999; Zwiebel & Takken, 2004). Anthropophilic mosquitoes are sensitive to a narrow range of chemical stimuli and they primarily take blood meals from humans.

More opportunistic vectors have a more general sensitivity to a wide range of chemical volatiles, which enables them to feed on humans and animals (Costantini *et al.*, 1999; Tirados *et al.*, 2006; Carey *et al.*, 2010).

To find a host, mosquitoes engage in upwind flight behaviour using carbon dioxide (CO<sub>2</sub>) (Dekker *et al.*, 2001). The universal kairomone, CO<sub>2</sub>, acts as an activator and attractant for host-searching mosquitoes (Gillies, 1980; Mboera & Takken, 1997; Spitzen *et al.*, 2008). Thereafter, they begin a directional flight towards humans when they encounter long-range host-kairomones up to around 70 m distance from the host, whereafter they initiate a landing response using volatiles emanating from human skin (Healy & Copland, 2000) and physical cues like heat, when at close range of their/the blood-meal host (Knols *et al.*, 1997; Spitzen *et al.*, 2013). The host-seeking behaviour of mosquitoes can be exploited using traps. Combining natural host odours, synthetic odour blends or skin bacterial volatiles with CO<sub>2</sub> causes an increase in mosquito catch in such traps (Spitzen *et al.*, 2008; Okumu *et al.*, 2010; Verhulst *et al.*, 2011a). Consequently, odour-baited traps can be used to catch malaria vectors in the field, hence reduce transmission of malaria (Homan *et al.*, 2016).

### **Role of skin bacterial volatiles in attraction of mosquitoes**

Volatiles from human skin microbiota are attractive to the anthropophilic mosquito *An. gambiae*, but not all skin bacterial species attract mosquitoes (Verhulst *et al.*, 2009; Verhulst *et al.*, 2011b). This suggests that *An. gambiae* selects its blood hosts based on specific bacterial volatiles released from the human skin (Verhulst *et al.*, 2010a; Verhulst *et al.*, 2010b). Humans are differentially attractive to malaria mosquitoes based on bacterial species on their skin (Verhulst *et al.*, 2010a). Highly attractive individuals harbour higher densities, but a lower diversity of bacteria on their skin, compared to poorly attractive individuals (Verhulst *et al.*, 2011b). This therefore suggests that attractiveness of humans to mosquitoes based on microbial diversity and/or density can have an effect on the number of mosquito bites received per person, hence the risk of malaria infection (Takken & Knols, 1999).

#### *Mechanisms of odour production by specific bacteria*

Different bacterial species on human skin have specific metabolism for generation of specific odour profiles. Corynebacteria generates volatile fatty acids which produce odour and only these bacteria transform long chain fatty acids into short and medium-chain fatty acids (C2-C11), causing malodour (James *et al.*, 2004). Micrococci and Brevibacteria metabolize the short and medium-chain fatty acids even further (James *et al.*, 2004). *Staphylococcus* species convert amino acids to highly odorous short-chain amino acids (James *et al.*, 2004) that are available as host-seeking cues (Smallegange *et al.*, 2009).

### **Manipulation of vertebrate hosts by *Plasmodium* parasites**

Besides variation caused by skin bacteria in attractiveness of healthy humans, it is also expected that the presence of diseases/parasites can alter host attractiveness. To optimize *Plasmodium* transmission, malaria-infected mosquito vectors carrying transmissible stages (sporozoites) should preferentially bite non-infected hosts, while infected hosts carrying transmissible stages (gametocytes) should be more attractive to healthy vectors than hosts without transmissible stages. Various studies in non-human systems indeed demonstrated altered mosquito feeding behaviour such as probing, persistence and engorgement rate upon *Plasmodium* infection (Hurd, 2003), suggesting manipulation of mosquito vectors by

*Plasmodium* (Cator *et al.*, 2012). *Anopheles gambiae* mosquitoes infected with sporozoites also showed increased attraction to the odour of healthy humans compared to non-infected mosquitoes (Smallegange *et al.*, 2013).

In addition to changes in infected vectors, infected rodent and bird hosts received more bites from mosquitoes than non-infected hosts (Ferguson & Read, 2004; Cornet *et al.*, 2013a, 2013b). Kenyan children infected with transmissible stages of *P. falciparum* (gametocytes) attracted significantly more mosquitoes than non-infected children (Lacroix *et al.*, 2005), suggesting that malaria parasites may also manipulate their human hosts to enhance transmission. The mechanism underlying this manipulation are thought to include changes in the infected individual's breath or body odour (Lacroix *et al.*, 2005), and are further investigated in this thesis.

### **Bottlenecks in malaria control**

Interventions such as insecticide treated bed-nets and indoor residual spraying combined with effective anti-malaria drugs have reduced vector-host contact and reduced the malaria burden significantly (Bhatt *et al.*, 2015). This reduction in malaria is aided by increased funding towards malaria control strategies (WHO, 2012, 2015a). However, due to the changing malaria transmission landscape with secondary vector species becoming more important (Sriwichai *et al.*, 2016), outdoor residual transmission (Durnez & Coosemans, 2013; Russell *et al.*, 2013), continued emergence and spread of parasite resistance to antimalarial drugs, resistance of mosquitoes to insecticides (WHO, 2015b) and lack of a standardised reliable vector control tool (Alonso *et al.*, 2011), additional knowledge and/or alternative methods for vector control are urgently needed. This is especially important because a single strategy may not be effective in all malaria-endemic countries as some countries/regions have set targets on elimination of malaria.

### **Aim of the study**

This PhD thesis was undertaken to investigate the effects of *Plasmodium* parasites and skin bacteria in mediating responses of malaria vectors to human body odours, a novel approach that could contribute to improvement of odour-baited traps. Findings from this study may also have an impact on epidemiological models of malaria transmission in a sense that if



mosquitoes do not bite people randomly but malaria parasites influence the chance of hosts being bitten by mosquitoes, this affects the transmission cycle.

Such knowledge can therefore be exploited to improve current interventions. Specifically, I addressed three research questions listed below, with specific objectives of the study and outline of the thesis listed hereafter.

#### Research questions

1. Do volatiles produced by skin bacteria play a role in species-specific host preference of mosquitoes?
2. Does infection with gametocytes of *Plasmodium* increase the attractiveness of humans to malaria mosquitoes?
3. What is the mechanism through which *Plasmodium* influences human attractiveness to malaria mosquitoes?

#### Specific objectives

1. Determine whether mosquito host preference affects the mosquito's response to synthetic and natural odour blends.
2. Investigate whether volatiles from skin bacteria mediate the response of malaria mosquitoes with different host preferences.
3. Develop hypotheses on how malaria parasites manipulate their vertebrate host to enhance transmission, based on literature.
4. Investigate the effect of different *Plasmodium falciparum* lifecycle stages in humans on their attractiveness to malaria mosquitoes.
5. Evaluate the role of body odours and skin bacteria in differential attraction of *Plasmodium*-infected humans to malaria mosquitoes.

#### **Outline of the thesis**

In this thesis, I investigated the interactions between malaria parasites, human hosts and their associated skin bacteria, and mosquitoes, whose host-seeking behaviour was used to address my research questions. In **Chapter 2**, I determined the attractiveness of natural host odours and synthetic odour blends on mosquito species with different host preference in Kenya. This

study included screen house experiments with the anthropophilic *An. gambiae* and the more opportunistic *An. arabiensis* mosquitoes, as well as field experiments in a malaria-endemic area of Kenya. In **Chapter 3**, I tested the response of the anthropophilic and more opportunistic mosquito species to skin bacterial volatiles of vertebrate hosts, including human, cow and chicken (also used in Chapter 2). The response of both mosquito species to volatiles released from human-specific bacterial species was also tested in a screen house. Parasites can manipulate vectors directly to enhance their own transmission. They can also manipulate vertebrate hosts to indirectly influence vector attraction towards infected hosts, e.g. by making them more attractive to parasite-vectors.

**Chapter 4** is a review on this topic, and includes the fitness effects of malaria parasites on the vector and vertebrate host as well. Hypotheses on the mechanisms of malaria manipulation of vertebrates were developed and future research discussed. **Chapter 5** describes a study that investigated if *P. falciparum* parasites in Kenyan children affect the behaviour of mosquitoes, and if so, if a change in attractiveness of malaria-infected children is stage specific. I also looked at the effect of parasite density on mosquito behaviour. In **Chapter 6**, follow up experiments were conducted to investigate the mechanisms involved in the attractiveness of microscopic gametocyte carriers who were significantly more attractive to malaria mosquitoes than parasite-free children or individuals with asexual stages or submicroscopic gametocytes. For this purpose, a cage-assay was developed to determine mosquito preference between two skin odour samples or two skin bacterial samples obtained from the same individual before and after treatment with antimalarial drugs. Finally, in **Chapter 7**, results of this PhD study are discussed based on the research questions outlined above. Future perspectives including mechanisms of *Plasmodium*-mediated host attractiveness and identification of common attractive skin volatiles (from various natural hosts) that may be used to improve the existing odour-baited traps, DNA sequencing of skin bacteria from infected and non-infected humans for determination of bacterial densities and composition, and studies of their role in attractiveness to mosquitoes are discussed.

## References

- Alonso, P. L., Brown, G., Arevalo-Herrera, M., Binka, F., Chitnis, C. & Collins, F. (2011) A research agenda to underpin malaria eradication. *PLoS Medicine* 8: e1000406.
- Batwala, V., Magnussen, P. & Nuwaha, F. (2010) Are rapid diagnostic tests more accurate in diagnosis of *Plasmodium falciparum* malaria compared to microscopy at rural health centres? *Malaria Journal*, **9**, 1.
- Bhatt, S., Weiss, D., Cameron, E., Bisanzio, D., Mappin, B., Dalrymple, U., *et al.* (2015) The effect of malaria control on *Plasmodium falciparum* in Africa between 2000 and 2015. *Nature*, **526**, 207-211.
- Bousema, J. T., Schneider, P., Gouagna, L. C., Drakeley, C. J., Tostmann, A., Houben, R., *et al.* (2006) Moderate effect of artemisinin-based combination therapy on transmission of *Plasmodium falciparum*. *Journal of Infectious Diseases*, **193**, 1151-1159.
- Carey, A. F., Wang, G., Su, C.-Y., Zwiebel, L. J. & Carlson, J. R. (2010) Odorant reception in the malaria mosquito *Anopheles gambiae*. *Nature*, **464**, 66-71.
- Cator, L. J., Lynch, P. A., Read, A. F. & Thomas, M. B. (2012) Do malaria parasites manipulate mosquitoes? *Trends in Parasitology*, **28**, 466-470.
- Coetzee, M. (2004) Distribution of the African malaria vectors of the *Anopheles gambiae* complex. *The American Journal of Tropical Medicine and Hygiene*, **70**, 103-104.
- Cornet, S., Nicot, A., Rivero, A. & Gandon, S. (2013a) Both infected and uninfected mosquitoes are attracted toward malaria infected birds. *Malaria Journal*, **12**.
- Cornet, S., Nicot, A., Rivero, A. & Gandon, S. (2013b) Malaria infection increases bird attractiveness to uninfected mosquitoes. *Ecology Letters*, **16**, 323-329.
- Costantini, C., Sagnon, N. F., Torre, D. & Culluzzi, M. (1999) Mosquito behavioral aspects of vector–human interactions in the *Anopheles gambiae* complex *Parasitologia*, **41**, 209-217.
- Dekker, T., Takken, W. & Carde, R. T. (2001) Structure of host-odour plumes influences catch of *Anopheles gambiae s.s* and *Aedes aegypti* in a dual-choice olfactometer. *Physiological Entomology*, **26**, 124-134.

- Durnez, L. & Coosemans, M. (2013) Residual transmission of malaria: an old issue for new approaches. In *Anopheles Mosquitoes - new insights into malaria vectors* (ed. by S. Manguin). InTech, Rijeka.
- Ferguson, H. M. & Read, A. F. (2004) Mosquito appetite for blood is stimulated by *Plasmodium chabaudi* infections in themselves and their vertebrate hosts. *Malaria Journal*,**3**.
- Gillies, M. T. (1980) The role of carbon dioxide in host-finding by mosquitoes (Diptera: Culicidae): a review. *Bulletin of Entomological Research*,**70**, 525-532.
- Gonçalves, B. P., Tiono, A. B., Ouédraogo, A., Guelbéogo, W. M., Bradley, J., Nebie, I., *et al.* (2016) Single low dose primaquine to reduce gametocyte carriage and *Plasmodium falciparum* transmission after artemether-lumefantrine in children with asymptomatic infection: a randomised, double-blind, placebo-controlled trial. *BMC Medicine*,**14**, 1-11.
- Healy, T. & Copland, M. (2000) Human sweat and 2-oxopentanoic acid elicit a landing response from *Anopheles gambiae*. *Medical and Veterinary Entomology*,**14**, 195-200.
- Hermesen, C. C., Telgt, D. S., Linders, E. H., van de Locht, L. A., Eling, W. M., Mensink, E. J., *et al.* (2001) Detection of *Plasmodium falciparum* malaria parasites *in vivo* by real-time quantitative PCR. *Molecular and Biochemical Parasitology*,**118**, 247-251.
- Homan, T., Hiscox, A., Mweresa, C. K., Masiga, D., Mukabana, W. R., Oria, P., *et al.* (2016) The effect of mass mosquito trapping on malaria transmission and disease burden (SolarMal): a stepped-wedge cluster-randomised trial. *Lancet*,**388**, 1193-1201.
- Hurd, H. (2003) Manipulation of medically important insect vectors by their parasites. *Annual Review of Entomology*,**48**, 141-161.
- James, A., Hyliands, D. & Johnston, H. (2004) Generation of volatile fatty acids by axillary bacteria. *International Journal of Cosmetic Science*,**26**, 149-156.
- Killeen, G. F. & Smith, T. A. (2007) Exploring the contributions of bed nets, cattle, insecticides and excitorepellency to malaria control: a deterministic model of mosquito host-seeking behaviour and mortality. *Transactions of the Royal Society of Tropical Medicine and Hygiene* **101**, 867-880.

- Kimani, E. W., Vulule, J. M., Kuria, I. W. & Mugisha, F. (2006) Use of insecticide-treated clothes for personal protection against malaria: a community trial. *Malaria Journal*,**5**, 1.
- Knols, B. G., van Loon, J. J., Cork, A., Robinson, R. D., Adam, W., Meijerink, J., *et al.* (1997) Behavioural and electrophysiological responses of the female malaria mosquito *Anopheles gambiae* (Diptera: Culicidae) to Limburger cheese volatiles. *Bulletin of Entomological Research*,**87**, 151-159.
- Lacroix, R., Mukabana, W. R., Gouagna, L. C. & Koella, J. C. (2005) Malaria infection increases attractiveness of humans to mosquitoes. *Plos Biology*,**3**, 1590-1593.
- Mboera, L. E. G. & Takken, W. (1997) Carbon dioxide chemotropism in mosquitoes (Diptera: Culicidae) and its potential in vector surveillance and management programmes. *Medical and Veterinary Entomology*,**85**, 355-368.
- McIver, S. B. (1982) Sensilla of mosquitoes (Diptera: Culicidae). *Journal of Medical Entomology*,**19**, 489-535.
- Okara, R. M., Sinka, M. E., Minakawa, N., Mbogo, C. M., Hay, S. I. & Snow, R. W. (2010) Distribution of the main malaria vectors in Kenya. *Malaria Journal*,**9**, 1.
- Okumu, F. O., Killeen, G. F., Ogoma, S., Biswaro, L., Smallegange, R. C., Mbeyela, E., *et al.* (2010) Development and field evaluation of a synthetic mosquito lure that is more attractive than humans. *Plos One*,**5**.
- RBM. (2013) *Annual report 2013: Roll back malaria partnership, Geneva, Switzerland.*
- Russell, T. L., Beebe, N. W., Cooper, R. D., Lobo, N. F. & Burkot, T. R. (2013) Successful malaria elimination strategies require interventions that target changing vector behaviours. *Malaria Journal*,**12**.
- Schneider, P., Schoone, G., Schallig, H., Verhage, D., Telgt, D., Eling, W., *et al.* (2004) Quantification of *Plasmodium falciparum* gametocytes in differential stages of development by quantitative nucleic acid sequence-based amplification. *Molecular and Biochemical Parasitology*,**137**, 35-41.
- Sinka, M. E., Bangs, M. J., Manguin, S., Rubio-Palis, Y., Chareonviriyaphap, T., Coetzee, M., *et al.* (2012) A global map of dominant malaria vectors. *Parasites & Vectors*,**5**.
- Smallegange, R. C., Qiu, Y. T., Bukovinszkiné-Kiss, G., Van Loon, J. J. A. & Takken, W. (2009) The effect of aliphatic carboxylic acids on olfaction-based host-seeking of the

- malaria mosquito *Anopheles gambiae sensu stricto*. *Journal of Chemical Ecology*, **35**, 933-943.
- Smallegange, R. C., van Gemert, G. J., van de Vegte-Bolmer, M., Gezan, S., Takken, W., Sauerwein, R. W., *et al.* (2013) Malaria infected mosquitoes express enhanced attraction to human odor. *Plos One*, **8**.
- Spitzen, J., Smallegange, R. C. & Takken, W. (2008) Effect of human odours and positioning of CO<sub>2</sub> release point on trap catches of the malaria mosquito *Anopheles gambiae sensu stricto* in an olfactometer. *Physiological Entomology*, **33**, 116-122.
- Spitzen, J., Spoor, C. W., Grieco, F., ter Braak, C., Beeuwkes, J., van Brugge, S. P., *et al.* (2013) A 3D analysis of flight behavior of *Anopheles gambiae sensu stricto* malaria mosquitoes in response to human odor and heat. *PLoS One*, **8**, e62995.
- Sriwichai, P., Samung, Y., Sumruayphol, S., Kiattibutr, K., Kumpitak, C., Payakkapol, A., *et al.* (2016) Natural human *Plasmodium* infections in major *Anopheles* mosquitoes in western Thailand. *Parasites and Vectors*, **9**, 17.
- Takken, W. (1991) The role of olfaction in host-seeking of mosquitoes: a review. *International Journal of Tropical Insect Science*, **12**, 287-295.
- Takken, W. & Knols, B. G. (1999) Odor-mediated behavior of Afrotropical malaria mosquitoes. *Annual Review of Entomology*, **44**, 131-157.
- Tirados, I., Costantini, C., Gibson, G. & Torr, S. (2006) Blood-feeding behaviour of the malarial mosquito *Anopheles arabiensis*: implications for vector control. *Medical and Veterinary Entomology*, **20**, 425-437.
- Verhulst, N. O., Andriessen, R., Groenhagen, U., Kiss, G. B., Schulz, S., Takken, W., *et al.* (2010a) Differential attraction of malaria mosquitoes to volatile blends produced by human skin bacteria. *Plos One*, **5**.
- Verhulst, N. O., Beijleveld, H., Knols, B. G. J., Takken, W., Schraa, G., Bouwmeester, H. J., *et al.* (2009) Cultured skin microbiota attracts malaria mosquitoes. *Malaria Journal*, **8**.
- Verhulst, N. O., Mbadi, P. A., Kiss, G. B., Mukabana, W. R., van Loon, J. J. A., Takken, W., *et al.* (2011a) Improvement of a synthetic lure for *Anopheles gambiae* using compounds produced by human skin microbiota. *Malaria Journal*, **10**.

- Verhulst, N. O., Qiu, Y. T., Beijleveld, H., Maliepaard, C., Knights, D., Schulz, S., *et al.* (2011b) Composition of human skin microbiota affects attractiveness to malaria mosquitoes. *Plos One*,**6**.
- Verhulst, N. O., Takken, W., Dicke, M., Schraa, G. & Smallegange, R. C. (2010b) Chemical ecology of interactions between human skin microbiota and mosquitoes. *Fems Microbiology Ecology*,**74**, 1-9.
- White, N. J., Pukrittayakamee, S., Tran Tinh, H., Faiz, M. A., Mokuolu, O. A. & Dondorp, A. M. (2014) Malaria. *Lancet*,**383**, 723-735.
- WHO. (2012) *World Malaria Report 2012*. WHO, Geneva: Switzerland.
- WHO. (2015a) *Action and investment to defeat malaria 2016-2030. For a malaria-free world*. WHO, Geneva, Switzerland.
- WHO. (2015b) *World Malaria Report 2015*. WHO, Geneva: Switzerland.
- Zwiebel, L. & Takken, W. (2004) Olfactory regulation of mosquito–host interactions. *Insect Biochemistry and Molecular Biology*,**34**(7), 645-652.

## Chapter 2

### Mosquito host preferences affect their response to synthetic and natural odour blends

Annette O. Busula, Willem Takken, Dorothy E. Loy, Beatrice H. Hahn,  
Wolfgang R. Mukabana and Niels O. Verhulst

Published in *Malaria Journal* (2015) 14:133



## Abstract

The anthropophilic malaria mosquito *Anopheles gambiae sensu stricto* (hereafter termed *Anopheles gambiae*) primarily takes blood meals from humans, whereas its close sibling *Anopheles arabiensis* is more opportunistic. Previous studies have identified several compounds that play a critical role in the odour-mediated behaviour of *An. gambiae*. This study determined the effect of natural and synthetic odour blends on mosquitoes with different host preferences to better understand the host-seeking behaviour of mosquitoes and the potential of synthetic odour blends for standardized monitoring. Odour blends were initially tested for their attractiveness to *An. gambiae* and *An. arabiensis* in a semi-field system with MM-X traps baited with natural and synthetic odours. Natural host odours were collected from humans, cows and chickens. The synthetic odour blends consisted of three or five previously identified compounds released with carbon dioxide. These studies were continued under natural conditions where odour blends were tested outdoors to determine their effect on species with different host preferences. In the semi-field experiments, human odour attracted significantly higher numbers of both mosquito species. However, *An. arabiensis* was also attracted to cow and chicken odours, which confirms its opportunistic behaviour. A five-component synthetic blend was highly attractive to both mosquito species. In the field, the synthetic odour blend caught significantly more *An. funestus* than traps baited with human odour, while no difference was found for *An. arabiensis*. Catches of *An. arabiensis* and *Culex spp.* contained large numbers of blood-fed mosquitoes, mostly from cows, which indicates that these mosquitoes had fed outdoors. Different odour baits elicit varying responses among mosquito species. Synthetic odour blends are highly effective for trapping mosquitoes; however, not all mosquitoes respond equally to the same odour blend. Combining fermenting molasses with synthetic blends in a trap represents the most effective tool to catch blood-fed mosquitoes outside houses, which is essential for understanding outdoor malaria transmission.

## Introduction

The host preference of a mosquito species is an important determinant of its vectorial capacity and mosquito species that are highly anthropophilic are often vectors of important human diseases (Takken & Verhulst, 2013). The anthropophilic malaria mosquitoes *An. gambiae sensu stricto* and *An. funestus s.s.* for example, primarily take blood meals on humans (Costantini *et al.*, 1999) and are two of the most important malaria vectors in Africa (WHO, 2013). *Anopheles arabiensis*, a close relative of *An. gambiae*, is more opportunistic, feeding on both humans and animals, and is considered a less important malaria vector (Tirados *et al.*, 2006; Takken & Verhulst, 2013). This difference in host preference is most evident in odour-guided behaviour, where *An. arabiensis* responds more strongly to carbon dioxide (CO<sub>2</sub>) as a general cue to find a host and *An. gambiae* mainly relies on specific human odours (Takken & Verhulst, 2013).

Carbon dioxide (CO<sub>2</sub>) is a major constituent of exhaled air and has been identified as an attractant for many mosquito species including the main vectors of malaria in Africa (Mboera *et al.*, 2000). Gillies (Gillies, 1980) suggested that this compound acts as an activator, initiating flight responses as well as being an attractant. There is strong evidence that CO<sub>2</sub> acts synergistically with other chemical compounds in natural and synthetic odour blends to attract host-seeking mosquitoes (Murphy *et al.*, 2001; Smallegange *et al.*, 2005; Njiru *et al.*, 2006; Jawara *et al.*, 2011; Mukabana *et al.*, 2012). This synergistic effect can be used in odour-baited traps in which CO<sub>2</sub> and synthetic blends that mimic human odour are combined (Okumu *et al.*, 2010; Mukabana *et al.*, 2012). These traps can then be used for monitoring, but can also intercept and reduce the number of malaria mosquitoes entering or leaving houses (Jawara *et al.*, 2011). A standard synthetic blend (SB) consisting of ammonia, (S)-lactic acid, tetradecanoic acid, and CO<sub>2</sub> was tested and found to be very efficient for trapping the malaria mosquito *An. gambiae* in a semi-field setting as well as in two traditional villages in western Kenya (Mukabana *et al.*, 2012). Significantly enhanced attraction of the SB blend to *An. gambiae* was achieved by adding 3-methyl-1-butanol and butan-1-amine (MB5 blend) (Hiscox *et al.*, 2014; Menger *et al.*, 2014; van Loon *et al.*, 2015). These attractive blends have been developed for anthropophilic *An. gambiae* mosquitoes (Smallegange *et al.*, 2005; Smallegange *et al.*, 2009; Verhulst *et al.*, 2011a; Verhulst *et al.*, 2011b; Mukabana *et al.*,

2012; van Loon *et al.*, 2015). However, less is known about their effect on the host-seeking behaviour of other mosquito species with different host preferences.

In this study, natural host odours and synthetic odour blends were dispensed from mosquito traps to determine the efficacy of synthetic blends for monitoring mosquito species with different host preferences. *Anopheles gambiae* and *An. arabiensis* mosquitoes, which are reported to be anthropophilic and opportunistic respectively (Tirados *et al.*, 2006; Takken & Verhulst, 2013), were simultaneously released in a semi-field system in western Kenya to determine their host-seeking behaviour, either in the presence of CO<sub>2</sub> alone, or combined with natural odours or the synthetic blends (SB and MB5).

In a field trial the efficacy of traps baited with natural odours or a synthetic blend was compared to determine the efficacy of the blend for different species of wild mosquitoes.

## **Materials and methods**

### **Mosquitoes**

The semi-field experiments utilized laboratory colonies of the Mbita strain of *An. gambiae sensu stricto* and *An. arabiensis*. Aquatic stages of the mosquitoes were separately reared under ambient atmospheric conditions in screen-walled greenhouses at the Thomas Odhiambo Campus Odhiambo (TOC) of the International Centre of Insect Physiology and Ecology (*icipe*), Mbita, Kenya. Adult mosquitoes were placed in a holding room under ambient conditions with a scotophase of 12:12 h. Female adult mosquitoes were fed three times a week on a human arm (Mweresa *et al.*, 2014). Eggs were laid on moist filter paper and dispensed into plastic trays containing filtered water from Lake Victoria. Newly hatched larvae were transferred into plastic basins and fed on Tetramin® baby fish food (Melle, Germany) three times a day. Collection of pupae until adult emergence is described in Mukabana *et al.* (2012). Female mosquitoes used for semi-field experiments were placed in mosquito netting covered plastic cups (Mukabana *et al.*, 2012). They had no prior access to a blood meal but were fed only on water, provided on wet cotton towels placed on top of mosquito holding cups during starvation (Mukabana *et al.*, 2012). All semi-field experiments were carried out at night (20:00–06:30 h) inside the screen houses (Verhulst *et al.*, 2011a). Two hundred females of *An. gambiae* and 200 *An. arabiensis* aged three to eight days old were painted with either pink or yellow fluorescent dyes (FTX Series, Astral Pink, Swada,

London) ten h before the experiments, as described before (Verhulst *et al.*, 2013). Mosquitoes were starved for eight h and simultaneously released at the centre of a screen-walled greenhouse.

### **Study sites**

Semi-field experiments were conducted between February and April 2013 in a 7x11 m screen house (Add. figure 1) constructed on the grounds of the Thomas Odhiambo Campus of ICIPE, Kenya (00° 25' S, 34°13'E). Field studies were conducted between May and June 2013 at Kigoche village, situated near Ahero town, in the Kano plains of Kisumu County, Kenya (Add. figure 2, 00°34'S, 34°65' E) (Bukhari *et al.*, 2011; Mukabana *et al.*, 2012). The area receives between 1,000 and 1,800 mm of rainfall annually with annual temperature and relative humidity (RH) ranges of 17-32°C and 44-80%, respectively. The long rainy season occurs between March and August while short rains are common in October to November. The main economic activity is rice farming which creates numerous mosquito larval habitats resulting in high malaria transmission. Indigenous goats, cattle, poultry and sheep are also kept in Kigoche (Mweresa *et al.*, 2014). During the night, domestic animals are tethered outdoors adjacent to houses occupied by humans. Many houses in the area are mud-walled with roofs made of corrugated iron sheets or thatch, or without ceiling. Eaves of most houses are open due to the high daytime temperatures (Atieli *et al.*, 2009).

### **Collection of natural host odours and preparation of CO<sub>2</sub>**

Human foot odour previously shown to be moderately attractive to mosquitoes (Mukabana *et al.*, 2002) was collected from nylon socks worn by a Kenyan male (age 31) (Add. figure 3). The socks were worn for 24 h before they were used in the experiment (Pates *et al.*, 2001). The volunteer did not smoke, use alcohol, spicy food, perfumes and the last shower was without soap (Mukabana *et al.*, 2002; Olanga *et al.*, 2010). Animal odours were collected by wrapping a clean nylon sock above the knee of a cow or around the leg of a chicken for 24 h (Add. figure 3). For the cow odour sample, a piece of cloth was wrapped over the sock to prevent dirt or faeces from contaminating the odour sample. Clean latex gloves were worn to avoid contamination by other odours.

Sugar and molasses were used to produce CO<sub>2</sub> in semi-field and field experiments respectively. Sugar-produced CO<sub>2</sub> was prepared by mixing 250 g sugar (Mumias Sugar

Company Ltd, Kenya), 17.5 g yeast (Angel®Company, China) and 2 litre (L) water in 5 L containers (Smallegange *et al.*, 2010). Molasses-produced CO<sub>2</sub> was obtained by mixing 2 L water, 250 g molasses (Mumias Sugar Company Ltd, Kenya) and 17.5 g dry instant yeast in 5 L containers (Mweresa *et al.*, 2014). Tap water was used during semi-field experiments while all field bioassays were conducted using clean water from Kigoche village. Released CO<sub>2</sub> was delivered through a 60-cm long silicon tubing (0.5 cm diameter) into individual MM-X traps (American Biophysics, North Kingstown, RI, USA) (Mweresa *et al.*, 2014). The MB5 and the SB blends used in the current study were separately prepared following protocols described before (Mukabana *et al.*, 2012; Menger *et al.*, 2014). Socks containing cow, chicken and human odour, and synthetic blends were separately hooked on a wire ring and hung inside the plume tube of a MM-X trap and always supplied with CO<sub>2</sub> from either molasses or sugar. Control traps were baited with CO<sub>2</sub> alone unless indicated specifically. The lower end of the plume tube was suspended 15 cm above ground level (Schmied *et al.*, 2008). Socks and synthetic blends were placed in glass jars, and stored in a freezer until and between experiments.

### **General experimental procedures**

All MM-X traps were operated using a 12 V battery. Vaseline pure petroleum jelly was applied on suspension wire bars, electrical cables and CO<sub>2</sub> tubing to prevent ants from preying on mosquitoes caught in the MM-X traps. A data logger (Tinytag® Ultra, model TGU-1500, INTAB Benelux, the Netherlands) was used to record ambient temperature and relative humidity at 30 min intervals. To terminate experiments, a plug was inserted into the outer tube of the MM-X trap, the CO<sub>2</sub> supply was cut off, and the power disconnected (Mweresa *et al.*, 2014). Traps containing mosquitoes were placed in a refrigerator at -4°C for 10 minutes. Immobilized mosquitoes were collected from each trap, counted, and recorded. Traps were cleaned between experiments using 70% ethanol (to remove residual odours). A manual, hand held aspirator was used to collect un-trapped, free-flying mosquitoes from the screen house.

The sand-filled floor of the greenhouse was moistened daily to enhance survival of mosquitoes. Latex gloves were worn during experiments to avoid contamination with human volatiles or other odorant compounds.

### **Attractiveness of natural host odours to laboratory-reared *An. gambiae* and *An. arabiensis***

MM-X traps were placed in all four corners of the screen-house, with identical treatments placed at opposite corners of the house. Each treatment pair was tested over four experimental nights. Treatments were rotated between the four corners of the screen-house every night to avoid the effect of site on mosquito catches. The treatment combination included: (i) CO<sub>2</sub> vs no stimulus (ii) cow odour +CO<sub>2</sub> vs clean sock+CO<sub>2</sub>, (iii) chicken odour +CO<sub>2</sub> vs clean sock + CO<sub>2</sub> and (iv) human odour + CO<sub>2</sub> vs clean sock + CO<sub>2</sub>.

### **Attractiveness of natural host odours to *An. gambiae* and *An. arabiensis* by competition**

A randomized 4 × 4 Latin square experimental design replicated over 16 nights was adopted. Treatments were rotated every night. The following treatments were added to each of the four MM-X traps: (i) only CO<sub>2</sub> and clean sock (control), (ii) cow odour +CO<sub>2</sub>, (iii) chicken odour +CO<sub>2</sub> and (iv) human odour +CO<sub>2</sub>.

### **Attractiveness of synthetic odour blends to *An. gambiae* and *An. arabiensis***

A randomized 4 × 4 Latin square experimental design was adopted and the experiment was conducted during 12 consecutive nights. The following treatments were added to each of the four MM-X traps: (i) only clean nylon strips without CO<sub>2</sub> (control), (ii) clean nylon strips + CO<sub>2</sub>, (iii) Simple Blend (SB: NH<sub>3</sub>+Lactic acid+C14+CO<sub>2</sub> and (iv) Mbita blend (MB5: NH<sub>3</sub>+Lactic acid+C14+3-methyl-1-butanol+Butan-1-amine (Hiscox *et al.*, 2014; Menger *et al.*, 2014; van Loon *et al.*, 2015; Homan *et al.*, 2016) + CO<sub>2</sub>.

### **Response of wild mosquitoes with different host preferences to natural and synthetic odour blends**

Five village houses were selected and experiments were carried out from 18.30 to 06.30 h each night. A randomized 5 × 5 Latin square experimental design was adopted. The houses were mud-walled, had open eaves, and corrugated iron sheet roofs (Mweresa *et al.*, 2014) and had owner occupants throughout the night sleeping under untreated bednets. The houses were located at least 25 m apart (Hill *et al.*, 2007) to exclude the potential interaction of treatments placed in any two adjacent houses. The treatments included a MM-X trap with CO<sub>2</sub> produced by molasses fermentation and (i) clean sock (ii) sock with cow odour (iii) sock

with chicken odour (iv) sock with human odour (v) MB5 blend. All the baited MM-X traps were hung outside the bedroom window, under the eaves (Verhulst *et al.*, 2011b). Individual treatments were rotated between the five houses every night. One experimental round lasted five nights and this was repeated five times, so every treatment was tested 25 nights.

### ***Anopheles* species identification**

Adult mosquitoes were identified morphologically (Gillies & Coetzee, 1987) and abdominal status was recorded (unfed, partially blood fed, fully blood fed, gravid) (WHO, 2013). Female *An. gambiae* s.l. and *An. funestus* s.l. were preserved in 2 ml Eppendorf tubes containing 80% ethanol and a subset (215 fully blood fed *An. gambiae* s.l. and 92 unfed *An. funestus* s.l.) was selected for DNA extraction (QiagenDNeasy kit) and molecular analysis. *Anopheles* complex was confirmed by PCR amplification, sequencing, and phylogenetic analysis of a 816 base pair (Ouédraogo *et al.*, 2016) fragment of the mosquito mitochondrial cytochrome oxidase I (COI) gene using primers (forward primer: 5'-YTGATTTTTTGGDCAYCCAGAA-3'; reverse primer: 5'-TTCATTGCACTAATCTGCCATA-3') designed to amplify multiple *Anopheles* species. Each PCR reaction used 0.5 µl mosquito DNA. Cycling conditions were 94°C for 5 minutes followed by 40 cycles of 94°C for 15 seconds, 52°C for 30 seconds, and 68°C for 1 minute with a final elongation step of 68°C for 10 minutes. *Anopheles gambiae* species were identified using a multiplex PCR approach as previously described (Scott *et al.*, 1993; Koekemoer *et al.*, 2002), while *Anopheles funestus* subspecies were determined by PCR amplification, sequencing, and phylogenetic sequence analysis of a 380-704 bp fragment of the rDNA gene using primers designed to amplify coding regions flanking the internal transcribed Spacer Region 2 (ITS2) domain (Koekemoer *et al.*, 2002).

### **Blood meal identification and detection of *Plasmodium***

Blood meals were identified using two independent PCR-based approaches. First, all samples were subjected to PCR amplification of the cytochrome *b* gene (132-680 bp amplicon) using primers designed to amplify human, cow, goat, pig and dog mitochondrial DNA (Kent & Norris, 2005). For each mosquito, human-, cow-, goat-, pig- and dog-specific forward primers were used in combination with a universal reverse primer in individual reactions to ensure sensitive detection of mixed blood meals using 0.5 µl of mosquito DNA per reaction.

PCR amplicons were sequenced and subjected to phylogenetic analysis. Second, all samples were also subjected to PCR amplification of the hypervariable D-loop region (498 bp) of the mammalian mitochondrial genome as described previously (Keele *et al.*, 2006) using 3 µl of mosquito DNA per reaction.

To identify *Plasmodium* infected mosquitoes, mosquito DNA was subjected to nested PCR targeting a 956 bp cytochrome *b* (*cytb*) fragment of the *Plasmodium* mitochondrial genome as described previously (Liu *et al.*, 2010; Prugnolle *et al.*, 2010). All PCR reactions used previously reported cycling conditions and the Roche Expand Long Template PCR system.

### **Ethical Considerations**

Scientific and ethical approval of the present study was granted by the Kenya Medical Research Institute (KEMRI/RES/7/3/1). Consent for houses used in the study was obtained from the household heads and the local administration prior to the start of the study.

### **Statistical analysis**

A Generalized Linear Model (GLM assuming a Binomial distribution, logit link function) was used to investigate the relative attractiveness of each combination of odours tested in the traps in the semi-field and field experiments, expressed as the number of mosquitoes caught in one of the traps divided by the total number of mosquitoes trapped in all traps during each experimental night (Qiu *et al.*, 2006; Verhulst *et al.*, 2011a). The effects of treatment, position of trap or house on mosquito catches were tested and fitted as parameters in the model when significant. Differences between treatments were tested by pairwise comparisons with Least Square Differences (Wheeler & Tiefelsdorf, 2005) correction. Effects were considered significant at  $P < 0.05$ . All analyses were performed using IBM SPSS statistical software, version 22.



## Results

### Attractiveness of natural host odours to laboratory-reared *An. gambiae* and *An. arabiensis*

In the semi-field studies, using laboratory-reared mosquitoes, we observed a significantly higher number of both *An. gambiae* and *An. arabiensis* in MM-X traps baited with CO<sub>2</sub> than in traps without CO<sub>2</sub> (P < 0.001; GLM, figure 1, Add. Table 1). Adding cow odour to the traps with CO<sub>2</sub> significantly decreased the number of *An. gambiae* caught (P < 0.001), but increased the number of *An. arabiensis* caught (P < 0.001, GLM, figure 1, Add. Table 2). The response of *An. gambiae* to traps baited with chicken odour was not significantly different than to the control of CO<sub>2</sub> alone (P = 0.102, GLM, figure 1), while significantly higher numbers of *An. arabiensis* responded to chicken odour than CO<sub>2</sub> alone (P < 0.001, GLM, figure 1). Traps baited with human odour caught significantly more mosquitoes than the control traps for both species (P < 0.001; GLM, figure 1).

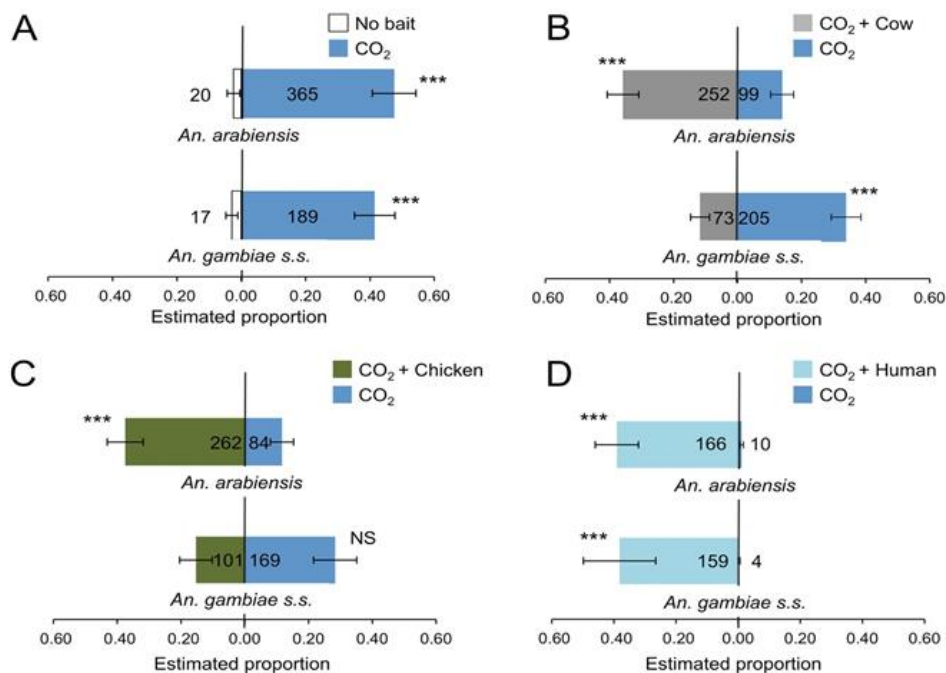

Figure 1. Screen house mosquito catches in dual-choice test with different odour baits. Estimated mean proportion (GLM) of mosquitoes caught in a screen house using MM-X traps with CO<sub>2</sub> tested *versus* an empty trap (A) Cow (B) chicken (C) and human (D) emanations were tested in combination with CO<sub>2</sub> *versus* a trap with CO<sub>2</sub> alone. Error bars represent the standard error of the mean; \*\*\*:  $\chi^2$ -test P < 0.001, NS:  $\chi^2$ -test P > 0.05. Numbers in the bars indicate number of mosquitoes caught.

### Attractiveness of natural host odours to *An. gambiae* and *An. arabiensis* by competition

Of 3,200 mosquitoes of each species released, 1,161 (36%) *An. gambiae* and 940 *An. arabiensis* (29%) were caught during the 16 experimental nights (GLM, figure 2). The response of *An. gambiae* to traps baited with human odour was significantly higher than to the other treatments ( $P < 0.05$ ; GLM, figure 2). The response of *An. arabiensis* was significantly higher to human odour than to cow odour or CO<sub>2</sub> alone ( $P < 0.001$ ), and close to significant when compared to chicken odour ( $P = 0.061$ , GLM, figure 2, Add. Table 3).

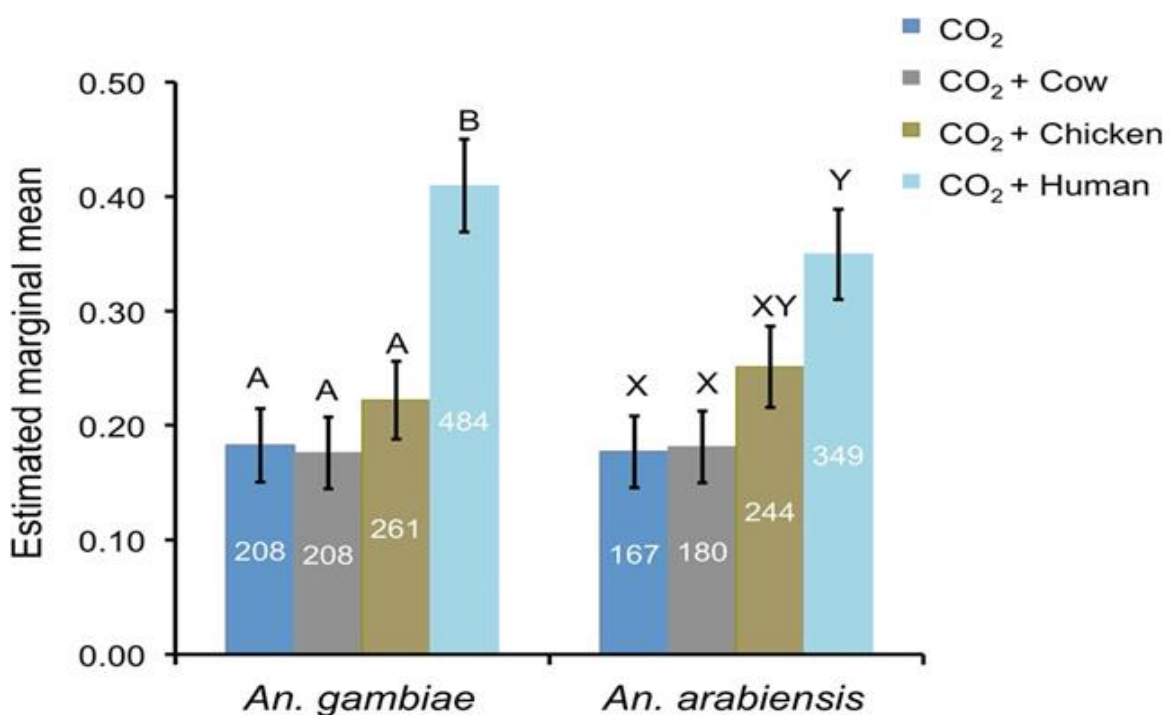

Figure 2. Competition experiment in a screen house with traps baited with natural odours from different host species. Estimated mean proportion (GLM) of mosquitoes caught in a screen house using MM-X traps with CO<sub>2</sub> only (control), or CO<sub>2</sub> and cow, chicken or human odours. Error bars represent the standard error of the mean. Numbers in the bars indicate number of mosquitoes caught. For each mosquito species: different letters indicate significant differences between treatments for each mosquito species ( $P < 0.05$ , GLM).

### Attractiveness of synthetic odour blends to *An. gambiae* and *An. arabiensis*

The attractiveness of all treatments was significantly different for both mosquito species, ( $P < 0.001$ , GLM, figure 3, Add. Table 4). The trap without CO<sub>2</sub> was least attractive to mosquitoes, followed by the traps baited with CO<sub>2</sub> alone, and then CO<sub>2</sub>+SB. Traps baited with CO<sub>2</sub> plus the MB5 blend were the most attractive to mosquitoes (GLM, figure 3).

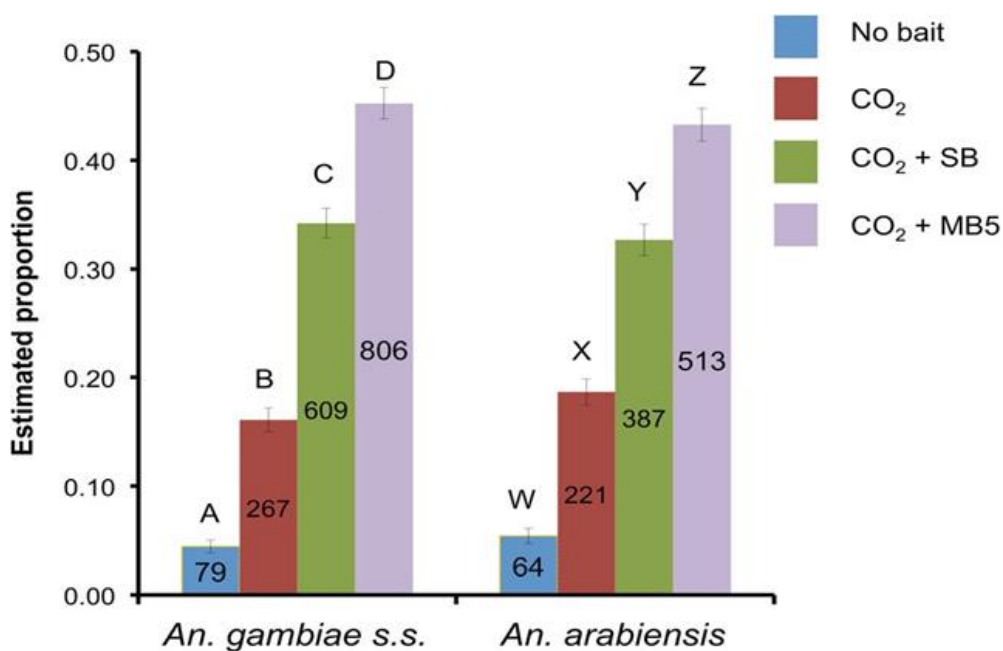

Figure 3. Screen house mosquito catches in traps baited with synthetic blends. Estimated mean proportion (GLM) of mosquitoes caught in a screen house using MM-X traps without (strips only) and with CO<sub>2</sub> (control) or with CO<sub>2</sub> plus synthetic blends. Error bars represent the standard error of the mean. Numbers in the bars indicate number of mosquitoes caught. For each mosquito species: different letters indicate significant differences between treatments ( $P < 0.05$ , GLM).

### Response of wild mosquitoes with different host preferences to natural and synthetic odour blends

A total of 6,057 wild mosquitoes were caught outdoors in Kigoche village over a period of 25 nights between May and June 2013. Of the 6,057 mosquitoes, 6% ( $n = 367$ ) were males and 94% ( $n = 5,690$ ) were females (Add. Table 5). Out of the 5,690 female mosquitoes trapped, 9% ( $n = 535$ ) were blood-fed.

For the 'unfed' mosquitoes, 16% (n = 816) were *An. arabiensis*, 23% (n = 1186) were *An. funestus*, 35% (n=1803) were Culicines, and 26% (n = 1350) were other mosquito species. In general, the traps baited with human odour plus the MB5 blend performed best trapping both *An. arabiensis* and *An. funestus* as well as other mosquito species (figure 4, Add. Tables 6,7). Compared to the response to CO<sub>2</sub> alone, the culicines did not show any enhanced attraction to the traps when natural odours or the synthetic blend were added (P > 0.05, GLM, figure 4C, Add. Table 6,7).

There was no significant difference in numbers of *An. arabiensis* caught in traps baited with CO<sub>2</sub> alone and traps baited with cow or chicken odours (P = 0.273, P = 0.703, respectively, GLM, figure 4A, Add. Tables 6,7). Human and MB5-baited traps attracted equal numbers of *An. arabiensis* (P = 0.887) and the catches were significantly higher than those of CO<sub>2</sub>, cow or chicken-baited traps (GLM, figure 4A, Add. Tables 6,7).

For unfed *An. funestus*, CO<sub>2</sub> and chicken odour were least attractive (P = 0.696, GLM figure 4B, Add. Tables 6,7). Cow or human odours were more attractive to *An. funestus* (P = 0.292) with higher catches than CO<sub>2</sub> (P = 0.007) or chicken (P = 0.020) but lower than the MB5 blend which was most attractive to *An. funestus* (P < 0.001, GLM figure 4B, Add. Tables 6,7).

A total of 535 out of 6,057 mosquitoes were blood-fed (figure 4). Of all the blood-fed mosquitoes, 278 (45%) were *An. arabiensis*, 29 (5%) were *An. funestus*, 202 (38%) were culicines and 56 (11%) were other mosquito species (GLM figure 4). There was a significantly higher number of blood fed *An. arabiensis* caught by MB5 compared to CO<sub>2</sub>, chicken or man (P < 0.036) but not compared to cow odour baited traps (P = 0.142, GLM, figure 4A, Add. Tables 7, 8). Blood-fed *An. funestus* were caught more often in traps baited with cow odour, human odour and the MB5 blend than traps baited with CO<sub>2</sub> alone (P < 0.021, GLM, figure 4B, Add. Tables 7, 8). No significant differences were found between culicines and other mosquito species trapped with the different treatments (P > 0.05, GLM, figure 4; Add. Table 7).

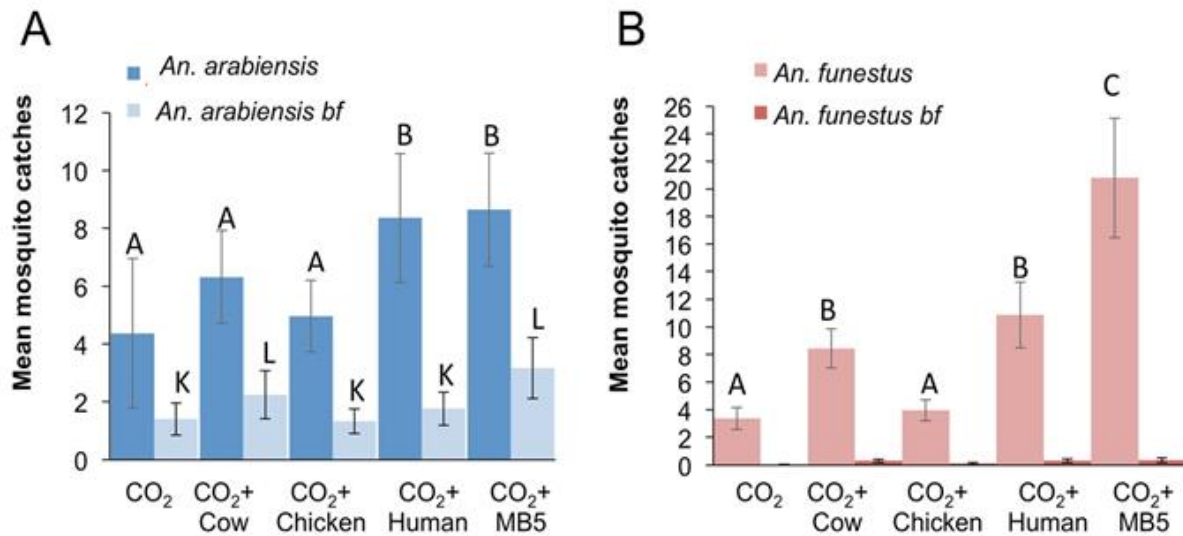

Figure 4. Mosquito catches in traps baited with natural and synthetic odours in a field set-up. Estimated mean proportion (GLM) of wild unfed or blood-fed mosquitoes caught outdoors. **A)** *An. arabiensis*, **B)** *An. funestus* s.l. caught outdoors using MM-X traps with CO<sub>2</sub> or CO<sub>2</sub> and treatments. Numbers in the bars indicate number of mosquitoes caught during 25 experimental nights. For each mosquito species: different letters indicate significant differences between treatments ( $P < 0.05$ , GLM).

### Molecular characterization of mosquitoes caught in field settings

To confirm the species origin of a subset of wild-caught mosquitoes, 215 fully blood-fed *An. gambiae* s.l. and 92 unfed *An. funestus* s.l. were subjected to mitochondrial DNA analysis. In concordance with previous studies (Menger *et al.*, 2014; Mweresa *et al.*, 2014), all *An. gambiae* s.l. were identified as *An. arabiensis* except for one that could not be typed due to insufficient material. Similarly, all *An. funestus* s.l. analysed were identified as *An. funestus sensu stricto*. Analysis of the same mosquitoes for the presence of *Plasmodium* DNA revealed that two *An. funestus* were positive for *P. falciparum* and one *An. funestus* was positive for *P. malariae*. None of the *An. arabiensis* were *Plasmodium* infected. Finally, blood meal analysis of 215 blood-fed *An. arabiensis* revealed that the vast majority had fed on cows, with 86% (184 out of 215) of mosquitoes positive for bovine mitochondrial (*cytb*) DNA (Table 1, Add. figure 5). Additionally, one *An. arabiensis* had fed on a caprid and one on a dog. Five (2%) *An. arabiensis* contained human DNA as determined by mitochondrial D-loop analysis, and this was confirmed for three samples by amplification of the *cytb* region. Four of these human blood meal positive mosquitoes were also positive for cow DNA,

indicating that these mosquitoes had taken multiple blood-meals from both humans and cows. Twenty-nine (13%) of the 215 *An. arabiensis* did not yield blood meal PCR amplicons.

**Table 1:** Blood meal identification of field caught mosquitoes

Blood meal origin	No. of <i>An. arabiensis</i> (percent)
<i>Single species blood meal</i>	
Cow	180 (83.3)
Caprid	1 (0.5)
Dog	1 (0.5)
Human	1 (0.5)
<i>Multiple species blood meal</i>	
Cow and human	4 (1.8)
<i>Blood meal undetectable</i>	29 (13.4)

## Discussion

The semi-field experiments presented here show that CO<sub>2</sub> is an important cue for both *An. gambiae s.s.* and *An. arabiensis* (figure 1). Carbon-dioxide, a major constituent of human exhaled air has been identified as an attractant for many mosquito species (Gillies, 1980; Mboera *et al.*, 2000) and including CO<sub>2</sub> in monitoring traps increases their efficacy as shown here. Human odour was highly attractive to both species (figure 1,2) and although this has been reported previously for *An. gambiae* in both field and laboratory studies (Gillies, 1964; Pates *et al.*, 2001; Takken & Verhulst, 2013), only a few studies have reported *An. arabiensis* to be more attracted to human compared to cow odour (Diatta *et al.*, 1998; Torr *et al.*, 2008; Lyimo *et al.*, 2013; Takken & Verhulst, 2013). The results show that *An. arabiensis* is opportunistic in nature. Moreover, human odour appeared to play a larger role than cow or chicken odour in the attractiveness to female *An. arabiensis*.

Interestingly, in some of the semi-field experiments presented here, adding cow or chicken odour to traps baited with CO<sub>2</sub> decreased the number of *An. gambiae s.s.* caught (figure 1). This effect has been reported before when CO<sub>2</sub> was added to cow odour in an olfactometer,

however, when only cow odour without CO<sub>2</sub> was present, the inhibiting effect was not observed (Pates *et al.*, 2001). A field study by Costantini *et al.* ( also indicated an aversion of *An. gambiae s.s.* to cattle odour when using odour baited entry traps. These studies and the results presented here further confirm the anthropophilic nature of this mosquito species and the importance of both human odour and CO<sub>2</sub> in its host seeking behaviour.

The MB5 blend has proven to be an effective synthetic blend for monitoring malaria mosquitoes (Hiscox *et al.*, 2014; Menger *et al.*, 2014). However, it was not clear from previous studies whether this blend would attract different species equally, and whether the host preference of these species would affect their preference to these blends. Our semi-field experiments demonstrate that two of the most important malaria vectors, *An. gambiae s.s.* and *An. arabiensis* can be trapped effectively by the MB5 blend, and that the difference in host preference of these two species does not influence their response to the blend. Field experiments also revealed a clear difference in response between the two important malaria vectors *An. funestus* and *An. arabiensis*. Although human odour and the MB5 blend attracted equal numbers of *An. arabiensis*, the synthetic blend attracted significantly more *An. funestus s.s.* than traps baited with human odour. Particular odour baits selected for monitoring purposes will therefore affect both the number of mosquitoes and the ratio between the species collected. The advantage of using the MB5 blend for monitoring is that it is standardized, highly effective (figure 4) and long lasting (Mweresa, pers. comm.).

No *Plasmodium* was detected in the *An. arabiensis* mosquitoes analysed; however, 3.3% of the *An. funestus s.s.* tested were *Plasmodium* positive. This result may be explained by the zoophilic nature of *An. arabiensis* and more anthropophilic behaviour of *An. funestus s.s.* Blood meal analysis indicated that 87% of the blood meals identified were of cow and only 2% of human origin. Since traps were hung outside, this result may reflect host availability rather than host preference (Lyimo & Ferguson, 2009). True host preference is better evaluated using choice tests (Takken & Verhulst, 2013) as performed in our semi-field experiments; however, host choice will largely depend on the host availability in the field (Takken & Verhulst, 2013). A previous study by Mweresa *et al.* (2014) showed that a trap with fermenting molasses, rather than fermenting sugar, significantly increased the number of

blood fed mosquitoes caught. The blood meal results presented here show that the use of fermenting molasses in a trap can catch mosquitoes that have fed outdoors, since most of the blood meals were from cows and typically cattle are kept outside human habitations. This result indicates that molasses-fermenting traps are very suitable for monitoring outdoor mosquitoes and thereby outdoor transmission.

In the last decade, Indoor Residual Spraying and the use of Long Lasting Impregnated Nets (LLINs) have reduced indoor mosquito populations and thereby malaria transmission (Bayoh *et al.*, 2010; Russell *et al.*, 2011). In areas where indoor transmission has been reduced substantially through the use of LLINs and IRS, the control of outdoor malaria has become more important and there is a need, therefore, for effective tools to monitor and reduce outdoor transmission. Outdoor odour-baited traps have become increasingly efficient for catching host-seeking mosquitoes. Nonetheless, they catch few or no blood-fed mosquitoes (Okumu *et al.*, 2010; Mukabana *et al.*, 2012).

The use of a synthetic odour blend as an attractant in traps is a very effective and standardized method for mosquito monitoring. Nonetheless, odour baits, including synthetic blends, are biased in their capture efficacy, which is an important consideration when monitoring or mass trapping mosquitoes. Currently no successful tools for trapping blood-fed mosquitoes outdoors are available. The combination of fermenting molasses with selected odour baits represents an important new tool for understanding outdoor mosquito behaviour, which will be of utility to measure, and possibly even reduce, outdoor transmission.

### **Acknowledgements**

We are grateful to David Alila for providing the laboratory-reared mosquitoes used during the semi-field experiments. Mrs. Margaret Ayugi and Mr. Erick Ambugo are thanked for making natural host odours available. We are thankful to Dr. Susan Imbahale and Mr. Fred Kisanya for the laboratory facility at the Ahero Multi-purpose Development Training Institute (AMDTI) and Mr. Charles Oketch for assistance in conducting field studies alongside Mr. Philemon Omusula. Our gratitude goes to household owners at Kigoche village for allowing us to conduct this study near their houses. This work was supported by a grant from the Earth and Life Sciences Foundation (Veni-ALW) of The Netherlands Organisation



for Scientific Research (NWO, 863.13.012) and grants from the National Institutes of Health (R01 AI091595, T32 AI007532, P30 AI045008).

## References

- Atieli, H., Menya, D., Githeko, A. & Scott, T. (2009) House design modifications reduce indoor resting malaria vector densities in rice irrigation scheme area in western Kenya. *Malaria Journal*,**8**.
- Bayoh, M. N., Mathias, D. K., Odiere, M. R., Mutuku, F. M., Kamau, L., Ginnig, J. E., *et al.* (2010) *Anopheles gambiae*: historical population decline associated with regional distribution of insecticide-treated bed nets in western Nyanza Province, Kenya. *Malaria Journal*,**9**.
- Bukhari, T., Takken, W. & Koenraadt, C. J. M. (2011) Development of *Metarhizium anisopliae* and *Beauveria bassiana* formulations for control of malaria mosquito larvae. *Parasites & Vectors*,**4**.
- Costantini, Sagnon, N., Torre, A. & Coluzzi, M. (1999) Mosquito behavioural aspects of vector-human interactions in the *Anopheles gambiae* complex. *Parassitologia*,**41**, 209-220.
- Costantini, C., Sagnon, N., Della Tori, A., Diallo, M., Brady, J., Gibson, G., *et al.* (1998) Odor-mediated host preferences of West African mosquitoes, with particular reference to malaria vectors. *American Journal of Tropical Medicine and Hygiene*,**58**, 56-63.
- Diatta, M., Spiegel, A., Lochouarn, L. & Fontenille, D. (1998) Similar feeding preferences of *Anopheles gambiae* and *An. arabiensis* in Senegal. *Transactions of the Royal Society of Tropical Medicine and Hygiene*,**92** (3):270-272.
- Gillies, M. (1964) Selection for host preference in *Anopheles gambiae*. *Nature*,**203**, 852-854.
- Gillies, M. & Coetzee, M. (1987) *A supplement to the anophelinae of Africa South of the Sahara (Afrotropical region)*. S Afric Inst Med Res, Johannesburg.
- Gillies, M. T. (1980) The role of carbon dioxide in host-finding by mosquitoes (Diptera: Culicidae): a review. *Bulletin of Entomological Research*,**70**, 525-532.
- Hill, N., Lenglet, A., Arnez, A. M. & Carneiro, I. (2007) Plant based insect repellent and insecticide treated bed nets to protect against malaria in areas of early evening biting

- vectors: double blind randomised placebo controlled clinical trial in the Bolivian Amazon. *British Medical Journal*,**335**, 1023-1025.
- Hiscox, A., Otieno, B., Kibet, A., Mweresa, C. K., Omusula, P., Geier, M., *et al.* (2014) Development and optimization of the Suna trap as a tool for mosquito monitoring and control. *Malaria Journal*,**13**.
- Homan, T., Hiscox, A., Mweresa, C. K., Masiga, D., Mukabana, W. R., Oria, P., *et al.* (2016) The effect of mass mosquito trapping on malaria transmission and disease burden (SolarMal): a stepped-wedge cluster-randomised trial. *Lancet*,**388**, 1193-1201.
- Jawara, M., Awolola, T. S., Pinder, M., Jeffries, D., Smallegange, R. C., Takken, W., *et al.* (2011) Field Testing of Different Chemical Combinations as Odour Baits for Trapping Wild Mosquitoes in The Gambia. *Plos One*,**6**.
- Keele, B. F., Van Heuverswyn, F., Li, Y., Bailes, E., Takehisa, J., Santiago, M. L., *et al.* (2006) Chimpanzee reservoirs of pandemic and nonpandemic HIV-1. *Science*,**313**, 523-526.
- Kent, R. J. & Norris, D. E. (2005) Identification of mammalian blood meals in mosquitoes by a multiplexed polymerase chain reaction targeting cytochrome B. *American Journal of Tropical Medicine and Hygiene*,**73**, 336-342.
- Koekemoer, L., Kamau, L., Hunt, R. & Coetzee, M. (2002) A cocktail polymerase chain reaction assay to identify members of the *Anopheles funestus* (Diptera: Culicidae) group. *American Journal of Tropical Medicine and Hygiene*,**66**, 804-811.
- Liu, C., Pitts, R. J., Bohbot, J. D., Jones, P. L., Wang, G. & Zwiebel, L. J. (2010) Distinct olfactory signaling mechanisms in the malaria vector mosquito *Anopheles gambiae*. *PLoS biology*,**8**.
- Lyimo, I. N. & Ferguson, H. M. (2009) Ecological and evolutionary determinants of host species choice in mosquito vectors. *Trends in Parasitology*,**25**, 189-196.
- Lyimo, I. N., Haydon, D. T., Russell, T. L., Mbina, K. F., Daraja, A. A., Mbehela, E. M., *et al.* (2013) The impact of host species and vector control measures on the fitness of African malaria vectors. *Proceedings of the Royal Society B-Biological Sciences*,**280**.
- Mboera, L. E. G., Knols, B. G. J., Braks, M. A. H. & Takken, W. (2000) Comparison of carbon dioxide-baited trapping systems for sampling outdoor mosquito populations in Tanzania. *Medical and Veterinary Entomology*,**14**, 257-263.

- Menger, D. J., Van Loon, J. J. A. & Takken, W. (2014) Assessing the efficacy of candidate mosquito repellents against the background of an attractive source that mimics a human host. *Medical and Veterinary Entomology*,**28**, 407-413.
- Mukabana, W. R., Mweresa, C. K., Otieno, B., Omusula, P., Smallegange, R. C., van Loon, J. J. A., *et al.* (2012) A novel synthetic odorant blend for trapping of malaria and other African mosquito species. *Journal of Chemical Ecology*,**38**, 235-244.
- Mukabana, W. R., Takken, W., Coe, R. & Knols, B. G. (2002) Host-specific cues cause differential attractiveness of Kenyan men to the African malaria vector *Anopheles gambiae*. *Malaria Journal*,**1**, 17.
- Murphy, M. W., Dunton, R. F., Perich, M. J. & Rowley, W. A. (2001) Attraction of *Anopheles* (Diptera: culicidae) to volatile chemicals in Western Kenya. *Journal of medical entomology*,**38**, 242-244.
- Mweresa, C. K., Omusula, P., Otieno, B., van Loon, J. J. A., Takken, W. & Mukabana, W. R. (2014) Molasses as a source of carbon dioxide for the malaria mosquitoes *Anopheles gambiae* and *Anopheles funestus*. *Malaria Journal*,**13**: 160.
- Njiru, B. N., Mukabana, W. R., Takken, W. & Knols, B. G. J. (2006) Trapping of the malaria vector *Anopheles gambiae* with odour-baited MM-X traps in semi-field conditions in western Kenya. *Malaria Journal*,**5**.
- Okumu, F. O., Killeen, G. F., Ogoma, S., Biswaro, L., Smallegange, R. C., Mbeyela, E., *et al.* (2010) Development and field evaluation of a synthetic mosquito lure that is more attractive than humans. *Plos One*,**5**.
- Olanga, E. A., Okal, M. N., Mbadi, P. A., Kokwaro, E. D. & Mukabana, W. R. (2010) Attraction of *Anopheles gambiae* to odour baits augmented with heat and moisture. *Malaria Journal*,**9**.
- Ouedraogo, A., Goncalves, B., Gneme, A., Wenger, E., Guelbéogo, M., Ouedraogo, A., *et al.* (2016) Dynamics of the human infectious reservoir for malaria determined by mosquito feeding assays and ultrasensitive malaria diagnosis in Burkina Faso. *Journal of Infectious Diseases*,**213** (1): 90-99.
- Pates, H. V., Takken, W., Stuke, K. & Curtis, C. F. (2001) Differential behaviour of *Anopheles gambiae sensu stricto* (Diptera : Culicidae) to human and cow odours in the laboratory. *Bulletin of Entomological Research*,**91**, 289-296.

- Prugnolle, F., Durand, P., Neel, C., Ollomo, B., Ayala, F. J., Arnathau, C., *et al.* (2010) African great apes are natural hosts of multiple related malaria species, including *Plasmodium falciparum*. *Proceedings of the National Academy of Sciences of the United States of America*, **107**, 1458-1463.
- Qiu, Y. T., Smallegange, R. C., Van Loon, J. J. A., Ter Braak, C. J. F. & Takken, W. (2006) Interindividual variation in the attractiveness of human odours to the malaria mosquito *Anopheles gambiae s. s.* *Medical and Veterinary Entomology*, **20**, 280-287.
- Russell, T. L., Govella, N. J., Azizi, S., Drakeley, C. J., Kachur, S. P. & Killeen, G. F. (2011) Increased proportions of outdoor feeding among residual malaria vector populations following increased use of insecticide-treated nets in rural Tanzania. *Malaria Journal*, **10**.
- Schmied, W. H., Takken, W., Killeen, G. F., Knols, B. G. J. & Smallegange, R. C. (2008) Evaluation of two counterflow traps for testing behaviour-mediating compounds for the malaria vector *Anopheles gambiae s.s.* under semi-field conditions in Tanzania. *Malaria Journal*, **7**.
- Scott, J., Brogdon, W. & Collins, F. (1993) Identification of single specimens of the *Anopheles gambiae* complex by the polymerase chain reaction. *American Journal of Tropical Medicine and Hygiene*, **49**.
- Smallegange, R. C., Qiu, Y. T., Bukovinszkiné-Kiss, G., Van Loon, J. J. A. & Takken, W. (2009) The effect of aliphatic carboxylic acids on olfaction-based host-seeking of the malaria mosquito *Anopheles gambiae sensu stricto*. *Journal of Chemical Ecology*, **35**, 933-943.
- Smallegange, R. C., Qiu, Y. T., van Loon, J. J. A. & Takken, W. (2005) Synergism between ammonia, lactic acid and carboxylic acids as kairomones in the host-seeking behaviour of the malaria mosquito *Anopheles gambiae sensu stricto* (Diptera: Culicidae). *Chemical Senses*, **30**, 145-152.
- Smallegange, R. C., Schmied, W. H., van Roey, K. J., Verhulst, N. O., Spitzen, J., Mukabana, W. R., *et al.* (2010) Sugar-fermenting yeast as an organic source of carbon dioxide to attract the malaria mosquito *Anopheles gambiae*. *Malaria Journal*, **9**.
- Takken, W. & Verhulst, N. O. (2013) Host preferences of blood-feeding mosquitoes. *Annual Review of Entomology*, **58**, 433-453.

- Tirados, I., Costantini, C., Gibson, G. & Torr, S. (2006) Blood-feeding behaviour of the malarial mosquito *Anopheles arabiensis*: implications for vector control. *Medical and Veterinary Entomology*,**20**, 425-437.
- Torr, S., Della Torre, A., Calzetta, M., Costantini, C. & Vale, G. (2008) Towards a fuller understanding of mosquito behaviour: use of electrocuting grids to compare the odour-orientated responses of *Anopheles arabiensis* and *An. quadriannulatus* in the field. *Medical and veterinary entomology*,**22**, 93-108.
- van Loon, J. J. A., Smallegange, R. C., Bukovinszky-Kiss, G., Jacobs, F., De Rijk, M., Mukabana, W. R., *et al.* (2015) Mosquito attraction: Crucial role of carbon dioxide in formulation of a five-component blend of human-derived volatiles. *Journal of Chemical Ecology*,**41**, 567-573.
- Verhulst, N. O., Loonen, J. A. C. M. & Takken, W. (2013) Advances in methods for colour marking of mosquitoes. *Parasites & Vectors*,**6**.
- Verhulst, N. O., Mbadi, P. A., Kiss, G. B., Mukabana, W. R., van Loon, J. J. A., Takken, W., *et al.* (2011a) Improvement of a synthetic lure for *Anopheles gambiae* using compounds produced by human skin microbiota. *Malaria Journal*,**10**.
- Verhulst, N. O., Mukabana, W. R., Takken, W. & Smallegange, R. C. (2011b) Human skin microbiota and their volatiles as odour baits for the malaria mosquito *Anopheles gambiae* s.s. *Entomologia Experimentalis Et Applicata*,**139**, 170-179.
- Wheeler, D. & Tiefelsdorf, M. (2005) Multicollinearity and correlation among local regression coefficients in geographically weighted regression. *Journal of Geographical Systems*,**7**: 161-187.
- WHO. (2013) *World Malaria Report 2013*. WHO.

**Additional Figures and Tables**



**Additional Figure 1. Collection of host odours from legs of (A) a male human, (B) cow, and (C) from chicken.**

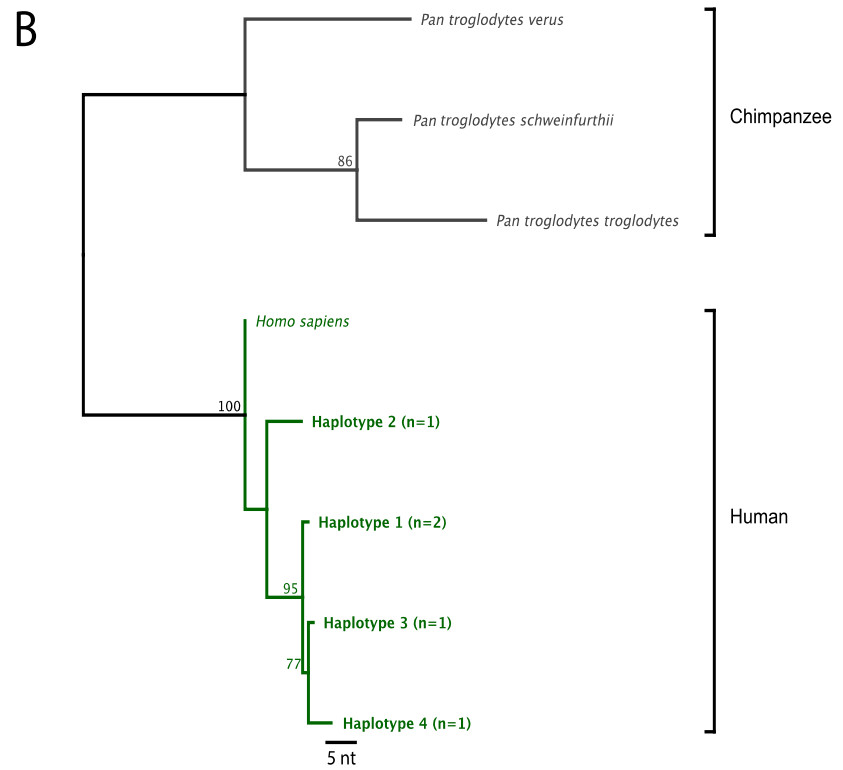
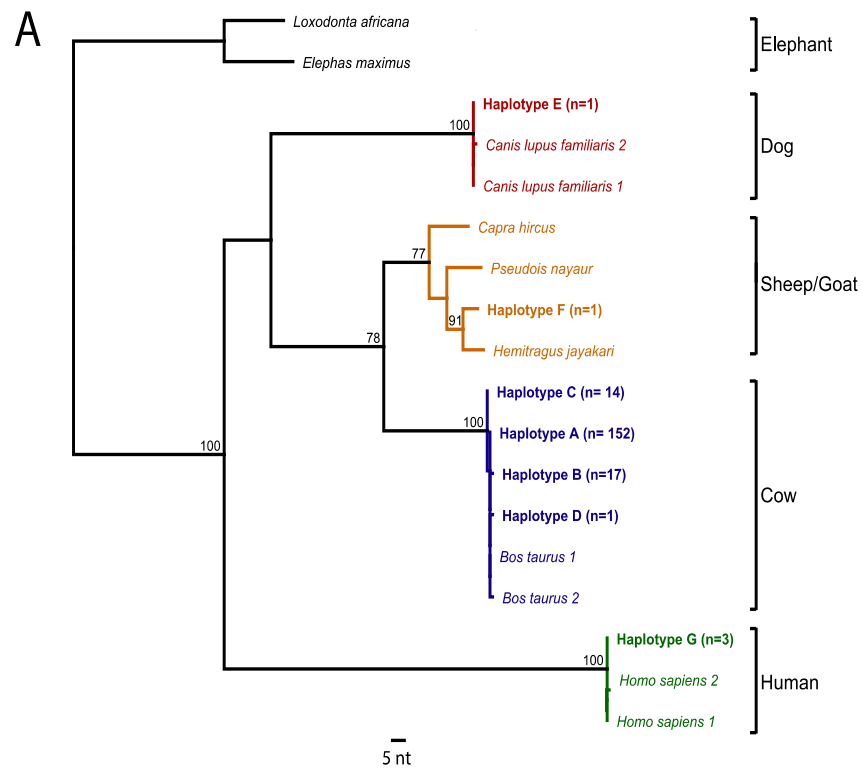

**Additional Figure 2. Blood meal analysis of wild caught *An. arabiensis***

DNA was extracted from wild-caught *An. arabiensis* and used to amplify (A) cytochrome B (*cytb*) and (B) hypervariable D-loop sequences using primers specific for mammalian mitochondrial sequences. (A) Phylogenetic tree of cytochrome B (*cytb*) gene (305 bp) sequences identifying blood meals of dog, sheep/ goat, cow and human origins. Seven distinct haplotypes (A-G) are shown in relation to reference sequences for *Bostaurus* (GenBank accession numbers AB090987 and DQ186224), *Homo sapiens* (AY495285 and KM102057), *Hemitragus jayakari* (AY846791), *Pseudoisnayaur* (JX101652), *Capra hircus* (D84201), and *Canis lupus familiaris* (KJ637145 and NC\_002008). (B), Phylogenetic tree of mitochondrial D-loop (313 bp) sequences, identifying four human blood meal haplotypes (1-4) in *An. arabiensis*. Reference sequences for *Pan troglodytesverus* (KJ606392.1), *Pan troglodytes troglodytes* (AJ851169.1), *Pan troglodytes schweinfurthii* (JQ812125.1), and *Homo sapiens* (KC005303.1) are shown. The number of *An. arabiensis* containing the respective blood meal haplotype is indicated in parenthesis. Both trees were inferred using maximum likelihood methods (Guindon *et al.*, 2010) in Geneious version 8.0.4 (Kearse *et al.*, 2012). Numbers above nodes indicate bootstrap values (> 70 %) and the scale bar represents 5 nucleotide substitutions.



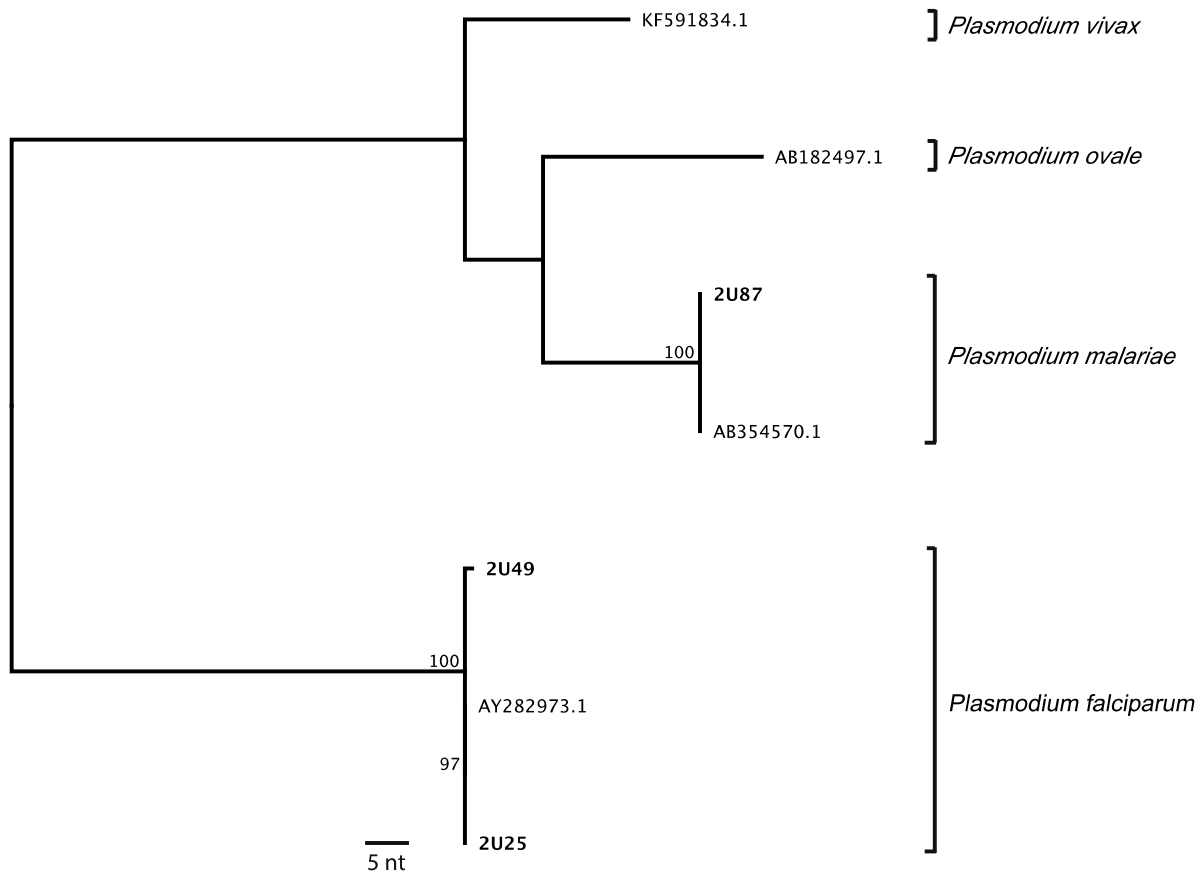

**Additional Figure 3. Identification of *Plasmodium falciparum* and *Plasmodium malariae* in wild caught mosquitoes**

The phylogenetic positions of *Plasmodium* cytochrome B (*cytb*) gene (689 bp) sequences amplified from three wild-caught *An. funestus* mosquitoes (sample numbers 2U25, 2U49, and 2U87) are shown in relation to reference sequences for *Plasmodium falciparum* (AY282973.1), *Plasmodium malariae* (AB354570.1), *Plasmodium vivax* (KF591834.1), and *Plasmodium ovale* (AB182497.1). The tree was inferred using maximum likelihood methods (Guindon *et al.*, 2010) in Geneious version 8.0.4 (Kearse *et al.*, 2012). Numbers above nodes indicate bootstrap Values (> 70%) and the scale bar represents 5 nucleotide substitutions.

**Additional Table 1. Mean ( $\pm$ SE) of mosquitoes caught in a screenhouse using MM-X traps with A) without CO<sub>2</sub>, B) cow, C) chicken and D) human odours. N=number of trapping nights.**

<b>A</b>				<b>B</b>			
		Mean ( $\pm$ SE)				Mean ( $\pm$ SE)	
Treatment	N	<i>An. gambiae</i>	<i>An. arabiensis</i>	Treatment	N	<i>An. gambiae</i>	<i>An. arabiensis</i>
CO <sub>2</sub>	4	47.25 $\pm$ 9.37	91.25 $\pm$ 26.22	CO <sub>2</sub>	4	51.25 $\pm$ 22.13	24.75 $\pm$ 3.75
Empty	4	4.25 $\pm$ 3.28	5.00 $\pm$ 2.80	Cow	4	18.25 $\pm$ 2.84	63.00 $\pm$ 0.82

<b>C</b>				<b>D</b>			
		Mean ( $\pm$ SE)				Mean ( $\pm$ SE)	
Treatment	N	<i>An. gambiae</i>	<i>An. arabiensis</i>	Treatment	N	<i>An. gambiae</i>	<i>An. arabiensis</i>
CO <sub>2</sub>	4	42.25 $\pm$ 5.76	21.00 $\pm$ 1.35	CO <sub>2</sub>	4	1.00 $\pm$ 0.71	2.50 $\pm$ 0.96
Chicken	4	25.25 $\pm$ 3.99	65.50 $\pm$ 1.76	Man	4	37.75 $\pm$ 21.15	41.50 $\pm$ 14.90

**Additional Table 2. Mean ( $\pm$ SE) of mosquitoes caught in a screenhouse using MM-X traps baited with natural host odours N=number of trapping nights.**

Treatment	N	Mean ( $\pm$ SE)	
		<i>An. gambiae</i>	<i>An. arabiensis</i>
Control (CO <sub>2</sub> only)	16	13.00 $\pm$ 2.73	10.44 $\pm$ 1.62
Cow	16	13.00 $\pm$ 2.55	11.25 $\pm$ 2.05
Chicken	16	16.31 $\pm$ 2.31	15.25 $\pm$ 2.99
Human	16	30.25 $\pm$ 5.60	21.81 $\pm$ 3.82

**Additional Table 3. P-values of pair-wise comparisons (GLM) after LSD correction, based on proportions of number of mosquitoes caught in a screenhouse by use of natural host odours. The mean difference is significant at the 0.05 level.**

Treatment	Comparison host odour+CO <sub>2</sub>	P values	
		<i>An. gambiae</i>	<i>An. arabiensis</i>
Chicken	Control	0.400	0.116
	Cow	0.319	0.137
	Human	<0.001	0.061
Control	Chicken	0.400	0.116
	Cow	0.882	0.924
	Human	0.000	0.001
Cow	Chicken	0.319	0.137
	Control	0.882	0.924
	Human	<0.001	0.001
Human	Chicken	<0.001	0.061
	Control	<0.001	0.001
	Cow	<0.001	0.001

**Additional Table 4. Mean ( $\pm$ SE) of mosquitoes caught in a screenhouse using MM-X traps baited with synthetic blends. N=number of trapping nights.**

Treatment	N	Mean ( $\pm$ SE)	
		<i>An. gambiae</i>	<i>An. arabiensis</i>
Control strips without CO <sub>2</sub>	12	6.58 $\pm$ 1.196	5.33 $\pm$ 1.05
CO <sub>2</sub>	12	23.92 $\pm$ 1.43	18.42 $\pm$ 1.12
SB	12	50.75 $\pm$ 2.43	32.25 $\pm$ 1.95
MB5	12	67.17 $\pm$ 2.50	42.75 $\pm$ 2.26

**Additional Table 5. Mean ( $\pm$ SE) of wild male mosquitoes caught outdoors using MM-X traps baited with natural host or synthetic odour blends. N=number of trapping nights.**

Treatment	N	<i>An. gambiae</i> s.l	<i>An. funestus</i>	<i>Culex spp.</i>	<i>Mansonia spp.</i>	<i>An. ziemmani</i>	<i>An. coustani</i>
Control	25	0.48 $\pm$ 0.15	0.52 $\pm$ 0.24	0.24 $\pm$ 0.15	0.40 $\pm$ 0.30	0	0
Cow	25	0.88 $\pm$ 0.32	0.68 $\pm$ 0.21	0.80 $\pm$ 0.28	0.44 $\pm$ 0.25	0	0.08 $\pm$ 0.08
Chicken	25	0.96 $\pm$ 0.29	0.92 $\pm$ 1.73	0.52 $\pm$ 1.05	2.40 $\pm$ 2.28	0.08 $\pm$ 0.06	0.24 $\pm$ 0.24
Human	25	0.40 $\pm$ 0.15	0.20 $\pm$ 0.10	0.40 $\pm$ 0.14	0.56 $\pm$ 0.232	0	0.08 $\pm$ 0.08
MB5	25	1.32 $\pm$ 0.44	0.76 $\pm$ 0.23	0.44 $\pm$ 0.22	0.68 $\pm$ 0.44	0.02 $\pm$ 0.01	0.11 $\pm$ 0.06

**Additional Table 6. Mean ( $\pm$ SE) of wild non-fed female mosquitoes caught outdoors using MM-X traps baited with natural or synthetic odour blends. N=number of trapping nights.**

		<i>An. arabiensis</i>	<i>An. funestus</i>	<i>Culex spp.</i>	<i>Mansonia spp.</i>	<i>An. ziemmani</i>	<i>An. coustani</i>	Unidentified
Control	25	4.36 $\pm$ 2.59	3.36 $\pm$ 0.80	13.4 $\pm$ 8.12	4.80 $\pm$ 1.63	0.04 $\pm$ 0.04	0.92 $\pm$ 0.65	0.16 $\pm$ 0.10
Cow	25	6.32 $\pm$ 1.61	8.44 $\pm$ 1.42	14.00 $\pm$ 2.87	10.92 $\pm$ 2.77	0.08 $\pm$ 0.06	1.60 $\pm$ 0.43	0.44 $\pm$ 0.21
Chicken	25	4.96 $\pm$ 1.25	3.96 $\pm$ 0.77	15.12 $\pm$ 3.39	7.04 $\pm$ 1.49	0.60 $\pm$ 0.29	1.56 $\pm$ 0.52	0.29 $\pm$ 0.13
Human	25	8.36 $\pm$ 2.23	10.88 $\pm$ 2.39	16.24 $\pm$ 3.56	7.92 $\pm$ 1.60	0.56 $\pm$ 0.40	2.32 $\pm$ 0.57	0.44 $\pm$ 0.327
MB5	25	8.64 $\pm$ 1.96	20.80 $\pm$ 4.33	13.36 $\pm$ 2.72	10.44 $\pm$ 2.16	0.04 $\pm$ 0.04	3.08 $\pm$ 1.27	0.76 $\pm$ 0.28

**Additional Table 7. Pair-wise comparisons of P values (GLM) based on proportions of wild mosquitoes caught in MM-X traps baited with natural and synthetic odour blends. The mean difference is significant at the 0.05 level.**

Treatment		A) Non blood-fed mosquitoes				B) Blood-fed mosquitoes			
		<i>An. gambiae</i> s.l	<i>An. funestus</i>	<i>Culex spp.</i>	<i>Mansonia spp.</i>	<i>An. gambiae</i> s.l	<i>An. funestus</i>	<i>Culex spp.</i>	<i>Mansonia spp.</i>
Chicken	CO <sub>2</sub>	0.703	0.696	0.675	0.176	0.945	0.370	0.120	0.826
	cow	0.423	0.020	0.787	0.172	0.072	0.141	0.341	0.525
	human	0.059	0.001	0.792	0.948	0.242	0.141	0.445	0.705
	MB5	0.042	<0.001	0.668	0.124	0.002	0.085	0.252	0.937
Control	chicken	0.703	0.696	0.675	0.176	0.945	0.370	0.120	0.826
	cow	0.237	0.007	0.882	0.01	0.059	0.021	0.549	0.673
	human	0.023	<0.001	0.495	0.145	0.212	0.021	0.431	0.875
	MB5	0.016	<0.001	0.992	0.007	0.001	0.010	0.684	0.890
Cow	chicken	0.423	0.020	0.787	0.172	0.072	0.141	0.341	0.525
	CO <sub>2</sub>	0.237	0.007	0.882	0.01	0.059	0.021	0.549	0.673
	human	0.276	0.292	0.593	0.182	0.514	1.000	0.851	0.788
	MB5	0.218	<0.001	0.874	0.834	0.142	0.805	0.847	0.580
Human	chicken	0.059	0.001	0.792	0.948	0.242	0.141	0.445	0.705
	CO <sub>2</sub>	0.023	<0.001	0.495	0.145	0.212	0.021	0.431	0.875
	cow	0.276	0.292	0.593	0.182	0.514	1.000	0.851	0.788
	MB5	0.887	<0.001	0.489	0.135	0.036	0.805	0.703	0.768
MB5	chicken	0.042	<0.001	0.668	0.124	0.002	0.085	0.252	0.937
	CO <sub>2</sub>	0.016	<0.001	0.992	0.007	0.001	0.010	0.684	0.890
	cow	0.218	<0.001	0.874	0.834	0.142	0.805	0.847	0.580
	human	0.887	<0.001	0.489	0.135	0.036	0.805	0.703	0.768

**Additional Table 8. Mean ( $\pm$ SE) of wild blood-fed mosquitoes caught outdoors using MM-X traps baited with natural and synthetic odour blends. N=number of trapping nights.**

Treatment		<i>An. arabiensis</i>	<i>An. funestus</i>	<i>Culex spp.</i>	<i>Mansonia spp.</i>	<i>An. ziemmani</i>	<i>An. coustani</i>
Control	25	1.40 $\pm$ 0.56	0.04 $\pm$ 0.04	1.20 $\pm$ 0.56	0.32 $\pm$ 0.15	0	0.20 $\pm$ 0.12
Cow	25	2.24 $\pm$ 0.83	0.32 $\pm$ 0.13	1.56 $\pm$ 0.59	0.40 $\pm$ 0.173	0	0
Chicken	25	1.32 $\pm$ 0.43	0.12 $\pm$ 0.09	2.20 $\pm$ 0.79	0.28 $\pm$ 0.20	0	0.04 $\pm$ 0.04
Human	25	1.76 $\pm$ 0.58	0.32 $\pm$ 0.14	1.68 $\pm$ 0.42	0.36 $\pm$ 0.21	0	0.08 $\pm$ 0.56
MB5	25	3.16 $\pm$ 1.06	0.36 $\pm$ 0.16	1.44 $\pm$ 0.39	0.28 $\pm$ 0.15	0	0.24 $\pm$ 0.20

## References

- Guindon, S., Dufayard, J. F., Lefort, V., Anisimova, M., Hordijk, W. & Gascuel, O. (2010) New algorithms and methods to estimate maximum-likelihood phylogenies: Assessing the performance of PhyML 3.0. *Systematic Biology*, **59**, 307-321.
- Kearse, M., Moir, R., Wilson, A., Stones-Havas, S., Cheung, M., Sturrock, S., *et al.* (2012) Geneious Basic: An integrated and extendable desktop software platform for the organization and analysis of sequence data. *Bioinformatics*, **28**,1647-1649.

## Chapter 3

Variation in host preference of malaria mosquitoes is  
mediated by skin bacterial volatiles

Annette O. Busula, Willem Takken, Jetske G. de Boer,  
Wolfgang R. Mukabana, Niels O. Verhulst

Accepted (Medical and Veterinary Entomology) 2017



## Abstract

Host preference of the anthropophilic mosquito species in the *Anopheles gambiae* complex (Diptera, Culicidae) is mediated by skin bacterial volatiles. However, it is not known if these mosquitoes respond differentially to skin bacterial volatiles from non-human host species. In this study, the response of two malaria mosquito species in the *An. gambiae* complex, *An. gambiae*s.s. (hereafter, *An. gambiae*) and *An. arabiensis*, with different host preferences to volatiles released from skin bacteria, was tested. Skin bacteria collected from human, cow and chicken significantly increased trap catches and traps containing bacteria collected from the human skin caught the highest proportion of *An. gambiae* and *An. arabiensis*. Traps with bacteria of human origin caught a significantly higher proportion of *An. gambiae* than *An. arabiensis*, while bacterial volatiles from chicken attracted significantly higher numbers of *An. arabiensis* than *An. gambiae*. Additionally, *An. gambiae* had a specialized response to volatiles from four specific bacteria, while *An. arabiensis* responded equally to all bacterial species tested. Skin bacterial volatiles may therefore play an important role in guiding mosquitoes with different host preferences. Identification of these bacterial volatiles can contribute to development of an odour blend that attracts mosquitoes with different host preferences.

## Introduction

Malaria is caused by *Plasmodium* parasites and has a worldwide impact on humans in terms of deaths, economic and social burden (Sachs & Malaney, 2002). *Plasmodium* parasites are transmitted by female *Anopheles* mosquitoes of which *An. funestus* and three members of the *An. gambiae* sensu lato complex, *An. gambiae*, *An. coluzzii* and *An. arabiensis* are the most important vectors in Africa (Sinka *et al.*, 2012; Coetzee *et al.*, 2013; WHO, 2015). *Anopheles gambiae* and *An. arabiensis* have different host preferences, which influences their efficiency as malaria vectors. *Anopheles gambiae* prefers blood-meals from humans (Costantini *et al.*, 1999), whereas *An. arabiensis* is considered more an opportunist, taking blood-meals from both animals and humans (Lyimo *et al.*, 2013; Ndenga *et al.*, 2016), although the host preference of these species varies between populations and geographic areas (Bøgh *et al.*, 2001; Takken & Verhulst, 2013). *Anopheles arabiensis* is thought to respond more strongly to carbon dioxide (CO<sub>2</sub>) as a general cue to find a host and *An. gambiae* mainly relies on specific human odours (Takken & Verhulst, 2013). However, in a recent study, human skin odour attracted higher numbers of both *An. gambiae* and *An. arabiensis*, compared to odours of other host species, although the preference of *An. gambiae* for the human odour was more pronounced (Busula *et al.*, 2015).

Skin odour is an important cue for host-seeking mosquitoes and consists of volatile organic compounds (VOCs) that originate either directly from the skin glands or after conversion by skin bacteria (Braks & Takken, 1999). These VOCs mainly consist of volatile fatty acids (Meijerink *et al.*, 2000), and different bacteria species produce different subsets of VOCs (Verhulst *et al.*, 2009). For example, corynebacteria, the most abundant micro-organisms on human skin, transform long-chain fatty acids into short and medium-chain fatty acids (James *et al.*, 2004). Brevibacteria metabolize the short and medium chain fatty acids even further (James *et al.*, 2004), while *Staphylococcus* which is also very abundant on the human skin (Council *et al.*, 2016) converts amino acids to highly volatile short-chain amino acids (James *et al.*, 2004). Mosquito vectors use some of these volatile short-chain fatty acids to locate their blood hosts (Knols & Takken, 1997; Smallegange *et al.*, 2011). Skin bacteria, and the volatile metabolic products they produce are therefore an important link between malaria vectors and humans (Verhulst *et al.*, 2010b).

When grown in vitro, human skin bacteria produce VOCs that are attractive to *An. coluzzii* (formerly *An. gambiae*) and some bacterial species are more attractive than others; volatiles from *Corynebacterium minutissimum* are highly attractive, while volatiles from *Pseudomonas aeruginosa* are poorly attractive to *An. coluzzii* (Verhulst *et al.*, 2010a). In addition, human individuals highly attractive to *An. coluzzii* have a higher abundance but lower diversity of bacteria on their skin than poorly attractive individuals (Verhulst *et al.*, 2011b), supporting the role of skin bacteria in mediating olfactory preferences of malaria mosquitoes.

Previous studies have determined the role of human skin bacterial volatiles in the host-seeking response of the anthropophilic mosquito *An. coluzzii*. In the current study, the role of bacterial volatiles in mediating responses of mosquitoes with different host preference to different host species, was determined. Attraction of *An. gambiae* and *An. arabiensis* to VOCs produced by either skin bacteria from three different host species or from previously tested bacterial species (Verhulst *et al.*, 2010a) was assessed under semi-field conditions to determine whether they mediate the host preference of malaria vectors.

## **Materials and methods**

### *Mosquitoes*

Colonies of *An. gambiae s.s* (Mbita strain, from Kenya, 2001) and *An. arabiensis* (Mwea strain from Kenya, 2004) were reared separately under ambient atmospheric conditions in screen-houses at the Thomas Odhiambo Campus (TOC) of the International Centre of Insect Physiology and Ecology (*icipe*), Mbita, Kenya. Adult mosquitoes were blood-fed on a human arm three times a week, and fed on 6% glucose solution provided through wicks of adsorbent tissue paper. Eggs were laid on moist filter paper and dispensed into plastic rearing trays (35 × 25 × 5 cm), containing filtered water from Lake Victoria. All larval instars were fed on cat food (Purina Go, U.K.), three times per day. Pupae were collected daily, placed in clean cups half filled with filtered lake water and transferred into mesh-covered cages (30 × 30 × 30 cm) prior to adult emergence. Two-hundred female *An. gambiae* and 200 female *An. arabiensis* aged 3-7 d that had no prior access to a blood-meal were randomly aspirated from the cages and transferred to small holding cups, 10 h before being used in semi-field experiments. The two species were colour-marked with either green or pink fluorescent powder (FTX Series, Astral Pink, Swada, London, UK) to distinguish them after simultaneous release (Verhulst *et*

*al.*, 2013). Mosquitoes were provided with water on cotton wool placed on top of mosquito holding cups until use in experiments.

#### *Collection of skin bacteria*

Skin bacteria were obtained from a chicken, a cow and a Kenyan man (34 years old). The man did not smoke, use perfumed cosmetics, take spicy food or alcohol, and the last shower before sample collection was without soap (Verhulst *et al.*, 2011b). He was also tested for presence of malaria parasites every two weeks to confirm that he did not have malaria. The chicken and cow had not received antibiotic treatment, vaccines and insecticide spray before and during collection of bacteria. Skin bacteria were collected by rubbing a cotton swab (BD BBL™ Culture Swab™ EZ II–Becton, Dickinson and Company, Sparks, USA) ten times over 10 cm<sup>2</sup> of the underside of the foot of the human, the skin above the knee of the cow or around the leg of the chicken (Supplementary information Figure. S1). The body sites for bacterial collection on the human and animal subjects matched the places for odour collection in a previous study (Busula *et al.*, 2015), to be able to compare the results of skin bacteria with skin odour. Collected bacteria were cultured on arrival in the laboratory (see below). Henceforth, collected chicken, cow and human skin bacteria will be referred to as “chicken bacteria”, “cow bacteria”, and “human bacteria”, respectively.

#### *Cultivation of bacteria*

Under sterile conditions, a tip of each bacterial swab obtained from chicken, cow or a human was cut off and transferred into an Eppendorf tube containing 1 mL of sterile distilled water. The second tip was stored at -20 °C. Of the bacteria in water, 100 µL was spread on 60 mm Tryptic Soy Agar (TSA; Bacto TSA, Becton & Dickinson, USA) plates, which were incubated at 34 °C (the normal human skin temperature) for 24 h before use in experiments. To determine the concentration of bacteria, 100 µL of the same solution of bacteria was spread on another TSA plate incubated at 34 °C and the colony forming units (cfu's) were counted after 24 h. New skin bacterial swabs were collected for each day of the experiments.

### *Cultivation of four bacteria common on human skin*

Four skin bacterial species that are common on the human skin were selected: *Staphylococcus epidermidis*, *Pseudomonas aeruginosa*, *Corynebacterium minutissimum* and *Brevibacterium epidermidis* (Verhulst *et al.*, 2010a). Bacteria were obtained from the Deutsche Sammlung von Mikroorganismen und Zellkulturen DSMZ (Germany) or in case of *P. aeruginosa*, from the laboratory of Microbiology at Wageningen University and Research, Wageningen, the Netherlands (Verhulst *et al.*, 2010a). Bacteria were grown separately by adding 10 µL of the glycerol stock of each species to five mL of liquid medium to support exponential growth of specific bacteria (Verhulst *et al.*, 2010a). The liquid medium consisted of: 2 g infusion from heart muscle, 13 g pancreatic digest of casein, 5 g yeast extract, 5 g sodium chloride (all Sigma-Aldrich, Munich, Germany) and 1 L sterile distilled water (Verhulst *et al.*, 2010a). Bacteria in liquid medium were incubated at 34 °C, at 225 rpm for 30 h. After incubation, 700 µL of each bacterial species was mixed with 300 µL glycerol and stored at -80 °C until use. Bacterial broths (glycerol stock) were decimally diluted 1:1; 1:10; 1:100 and 1:1,000 in phosphate buffered saline (PBS) and 50 µL of each dilution was plated on TSA plates. After incubation for 24 h at 34°C, the cfu's were counted. The concentration of the bacterial species with the smallest number of cfu's was identified and other bacteria species were diluted to the same concentration to obtain the same number of cfu's. In this case, 50 µL *C. minutissimum* diluted 1000 times had the least cfu's (77 cfu's) while 21.1 µL, 28.1 µL and 15.4 µL of the same concentration were used to obtain the same concentration for *B. epidermidis*, *P. aeruginosa* and *S. epidermidis*, respectively.

### **General experimental procedures for semi-field experiments**

Experiments were carried out in 7×11 m screen-houses constructed on the grounds of the TOC of *icipe*, located near Mbita Point township in Western Kenya (00°25'S, 34°13'E) (Verhulst *et al.*, 2011a). On each experimental day, the sand-covered floor of the screen-house was moistened with water to enhance survival of mosquitoes. The agar with bacteria of each TSA plate was cut into two pieces and placed inside a wire mesh holder in the air outlet of a Mosquito Magnet-X (MM-X) trap (Verhulst *et al.*, 2009). Carbon dioxide was added to each trap and prepared daily by mixing 17.5 g yeast (Angel ® Company, Yichang, China), 250 g sugar (Mumias Sugar Co Ltd, Mumias, Kenya), and 2 L water in 5 L plastic containers

(Smallegange *et al.*, 2010). Each trap was marked, and used for one specific treatment throughout the experiments to prevent contamination with the odours. Traps were placed 15 cm above the ground level, in the corners of the screen-house and positions were rotated to minimize positional effects (Mukabana *et al.*, 2012).

MM-X traps operated on 12-V batteries. Vaseline® pure petroleum jelly was applied on electrical cables, suspension wire bars and CO<sub>2</sub> tubing to prevent ants from preying on trapped mosquitoes. Two hundred green-marked *An. gambiae* and 200 pink-marked *An. arabiensis* were simultaneously released at the centre of the screen-house at 20:00 h until 06.30 h the following morning. To stop experiments, a plug was inserted into the outer tube of the trap, CO<sub>2</sub> supply was cut off, and the power disconnected. Traps containing mosquitoes were transported from the screen-house and placed in a freezer at -20 °C for 10 min. Immobilized mosquitoes were counted, and recorded. Traps and wire mesh that held TSA with bacteria in the traps were cleaned between experiments using 70 % ethanol. Wire mesh holders were further sterilized in an oven at 100 °C for about two h. A hand-held manual aspirator was used to collect untrapped, free-flying mosquitoes from the screen-house. Latex gloves were worn during experiments to avoid contamination of equipment and odour sources with human volatiles or bacteria.

#### *Attractiveness of natural host skin bacteria to An. gambiae and An. arabiensis*

MM-X traps were baited with skin bacteria from different host species, grown on agar plates to assess the attractiveness of the produced volatiles to *An. gambiae* and *An. arabiensis*. The traps were placed in the four corners of the screen-house and treatments rotated nightly. A randomized 4 × 4 Latin square experimental design was adopted and a total of 16 replicates was carried out. The treatment combinations included: (i) clean agar + CO<sub>2</sub> (control); (ii) cow bacteria + CO<sub>2</sub>; (iii) chicken bacteria + CO<sub>2</sub>; and (iv) human bacteria + CO<sub>2</sub>. Depending on the availability these experiments were carried out in one to three screen-houses simultaneously.

### *Attractiveness of specific bacteria to An. gambiae and An. arabiensis*

To test whether *An. gambiae* and *An. arabiensis* respond to a range of selected four common specific bacteria, a randomized 4 × 4 Latin square experimental design was conducted, incorporating incubated *S. epidermidis* + CO<sub>2</sub>, *C. minutissimum* + CO<sub>2</sub>, *B. epidermidis* + CO<sub>2</sub> and *P. aeruginosa* + CO<sub>2</sub>. MM-X traps containing each of the four bacterial species were placed in the four corners of the screen-house and treatments were rotated nightly for a total of 16 nights.

### **Ethical considerations**

Approval of this study was granted by the ethics committee of the Kenya Medical Research Institute (KEMRI/RES/7/3/1). Consent to collect skin bacteria was obtained from the 34 year old man and the owner of the cow and chicken.

### **Statistical analysis**

A generalized linear model (GLM), assuming a binomial distribution with logit link function, was used to investigate the relative attractiveness of each combination of bacteria tested in the traps, expressed as: the number of caught mosquitoes (per species) in one of the traps divided by the total number of mosquitoes of that species caught in all traps during each experimental night. The effects of day, host or bacterial species, mosquito species, cfu's, screen-house, position of trap and their two-way interactions on mosquito catches were fitted in the models and the non-significant factors dropped from the final model. Differences within species between odour sources and between species to the same odour sources were tested by pair-wise comparisons with least square differences (LSD) correction. Effects were considered significant at  $P < 0.05$ . All analyses were performed using IBM SPSS statistical software, version 23.

### **Results**

#### *Attractiveness of natural host skin bacteria to An. gambiae and An. arabiensis*

Of the 3,200 mosquitoes of each species released in the screen-house, 1,410 of *An. gambiae* (44%) and 1,397 of *An. arabiensis* (44%) were trapped. Responses within and between-mosquito species were compared and results showed that all bacterial volatiles attracted

significantly higher numbers of both mosquito species than the control agar (GLM,  $P < 0.001$ , Figure 1, Suppl. Inf.: Table S1) and volatiles from human bacteria were more attractive than bacterial volatiles from chicken or cow (GLM,  $P < 0.001$ , Figure 1). The interaction between mosquito species and host species was significant (GLM,  $P = 0.002$ , Figure 1), indicating that the two mosquito species responded differently to the bacterial volatiles released. Traps with bacteria of human origin contained 45% of all *An. gambiae* caught, which was about two times higher than traps with odour from bacteria collected from chicken or cow skin, and about four times higher than traps with clean agar (GLM,  $P < 0.05$ , Figure 1). The proportions of *An. arabiensis* caught in traps with clean agar, chicken, cow and human bacteria were 9%, 26%, 27% and 38% respectively (GLM, Figure 1). Comparing the responses of the two mosquito species showed that *An. gambiae* had a higher preference for human bacteria than *An. arabiensis* (GLM,  $P = 0.026$ , Figure 1), while the latter species was attracted more strongly to volatiles from chicken bacteria than *An. gambiae* (GLM,  $P = 0.014$ , Figure 1). No significant difference was found in the response of both mosquito species to volatiles from bacteria from cow skin (GLM,  $P = 0.219$ , Figure 1). Bacterial counts determined by the number of cfu's (Suppl. Inf.: Table S1), day of experiment and trap position did not influence the mosquito response and were excluded from the final model (GLM,  $P = 0.246$ ,  $P = 1.000$ ,  $P = 0.667$ , respectively).



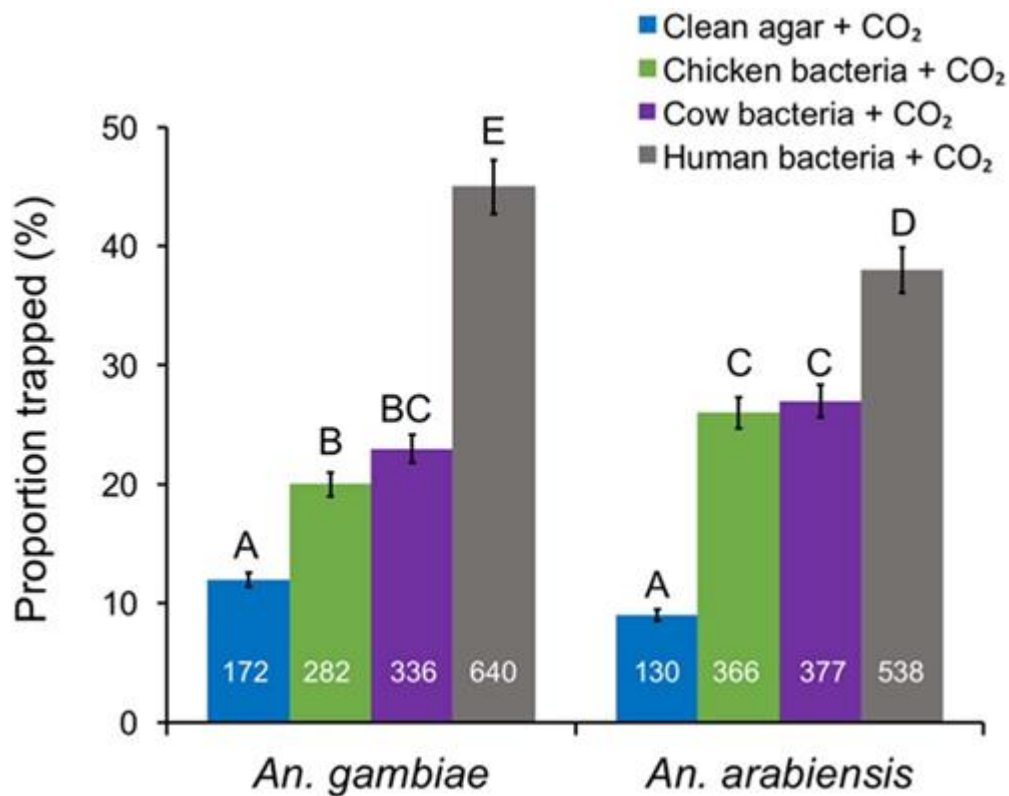

Figure 1. Screen-house experiment using traps baited with skin bacteria from different host species showing back-transformed proportions (GLM) of mosquitoes caught in MM-X traps with CO<sub>2</sub> and clean agar (control), or CO<sub>2</sub> and cow, chicken or human bacteria. Error bars represent the standard error of the proportion. Numbers in the bars indicate total number of mosquitoes caught in 16 experimental nights (200 released per night of each species). Different letters indicate significant differences between treatments and between the two mosquito species (GLM,  $P < 0.05$ ).

#### *Attractiveness of specific bacteria to An. gambiae and An. arabiensis*

The responses of *An. gambiae* and *An. arabiensis* to volatiles from specific bacteria were compared. In total, 3,200 mosquitoes of each species were released, of which 31% ( $n=994$ ) of *An. gambiae* and 25% ( $n=804$ ) of *An. arabiensis* were caught in the four traps during the 16 experimental nights. The GLM analysis revealed a significant interaction between mosquito species and bacterial species ( $P < 0.001$ ), indicating that the two mosquito species responded differently to the bacterial volatiles released. The proportions of *An. gambiae* caught in traps baited with *P. aeruginosa*, *S. epidermidis*, *B. epidermidis*, and *C. minutissimum* were 10%, 26%, 27%, and 37% respectively (Figure 2, GLM, Suppl. Inf.: Table S2). The response of *An. gambiae* to *C. minutissimum* was significantly higher than to the other bacteria species

(GLM,  $P < 0.05$ , Figure 2), while *P. aeruginosa* was least attractive to *An. gambiae* (GLM,  $P < 0.05$ , Figure 2).

In contrast to *An. gambiae*, *An. arabiensis* was equally trapped by the four bacterial species (GLM,  $P > 0.05$ , Figure 2, Suppl. Inf.: Table S2).

The relative response of *An. arabiensis* to *C. minutissimum* was significantly lower than that of *An. gambiae* (GLM,  $P = 0.001$ , Figure 2), while bacterial volatiles from *P. aeruginosa* were 2.5 times more attractive to *An. arabiensis* than to *An. gambiae* (GLM,  $P < 0.001$ , Figure 2). Attractiveness of mosquitoes was influenced by the interaction between screen-house and position of the trap and therefore included in the GLM ( $P < 0.001$ ). Day on which the experiment was conducted had no significant effect (GLM,  $P = 1.000$ ).

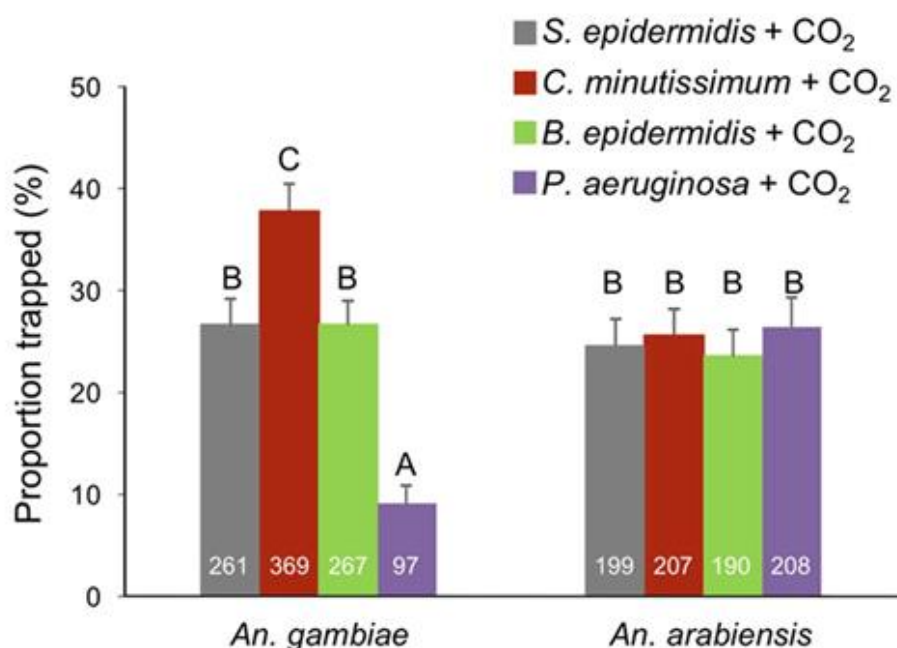

Figure 2. Proportion of mosquitoes trapped in traps baited with various bacteria in a screen-house, showing back-transformed proportions (GLM) of mosquitoes caught in traps baited with CO<sub>2</sub> and *C. minutissimum*, *S. epidermidis*, *B. epidermidis* or *P. aeruginosa*. Error bars represent the standard error of the proportion. Numbers in the bars indicate total number of mosquitoes caught in 16 experimental nights (200 released per night of each species). Different letters indicate significant differences between treatments, and between the two mosquito species (GLM,  $P < 0.05$ ).

## Discussion

The results of this study show that two closely related species in the *An. gambiae* complex in Kenya with different host preferences respond differently to skin bacterial volatiles from natural hosts, and to bacterial volatiles from individual bacterial species.

In the initial experiment, traps with bacteria caught significantly higher numbers of *An. gambiae* and *An. arabiensis* than traps baited with clean agar and CO<sub>2</sub>, supporting the earlier evidence of the importance of skin bacterial volatiles in the host-seeking behaviour of mosquitoes (Verhulst *et al.*, 2009; Verhulst *et al.*, 2011b).

This is a particularly interesting result regarding *An. arabiensis* host seeking behaviour, because of the evidence that this is a more opportunistic species than *An. gambiae*, and more reliant on CO<sub>2</sub> to locate hosts than are extremely anthropophilic species (Takken & Verhulst, 2013). A mix of volatiles released by human skin bacteria was significantly more attractive to both mosquito species than volatiles released by the skin bacteria of a cow or a chicken. However, bacteria of human origin were significantly more attractive to *An. gambiae* than to *An. arabiensis*. These results can be explained by the anthropophilic nature of *An. gambiae*, which has a strong preference for humans as a source of blood-meal (Gillies, 1964; Costantini *et al.*, 1999) and is attracted to human odour over animal odours (Lyimo *et al.*, 2013; Busula *et al.*, 2015). Some bacterial species are strongly associated with humans (Verhulst *et al.*, 2010b; Council *et al.*, 2016), which could have led to the production of volatiles that attracted *An. gambiae* more strongly than *An. arabiensis*. Preference of *An. gambiae* to human skin bacteria was also shown in previous semi-field experiments (Verhulst *et al.*, 2011a).

Further results showed that although *An. gambiae* prefers blood-meals from selected host species (Verhulst *et al.*, 2010b), a considerable proportion of mosquitoes in the current study entered traps baited with non-human bacteria, possibly due to an overlap in bacterial volatile profiles of different hosts. These results with skin bacterial volatiles closely resemble the response of *An. gambiae* to skin rubbings of the same hosts tested in a similar setup (Busula *et al.*, 2015).

*Anopheles arabiensis* is more zoophilic than *An. gambiae* and has a preference for biting cattle and other warm-blooded animals, although in some areas it has been found to be anthropophilic (Costantini *et al.*, 1996; Mutero *et al.*, 2004; Tirados *et al.*, 2006; Mahande *et al.*, 2007; Tirados *et al.*, 2011). *Anopheles arabiensis* rarely takes blood meals from chicken (Githeko *et al.*, 1994; Jaleta *et al.*, 2016), however, chicken odour was found to be either repellent (Jaleta *et al.*, 2016) or attractive (Busula *et al.*, 2015), depending on the setup. In this study, *An. arabiensis* responded more strongly to volatiles from human bacteria than volatiles from cow or chicken bacteria. These results match those of previous experiments with another *An. arabiensis* line (Mbita, Kenya), which showed that *An. arabiensis* was attracted more strongly to host odours from human compared to cow or chicken odours (Busula *et al.*, 2015), and may be explained by the colony being fed on human blood or by the differences in host preference between populations as indicated above. However, the response of *An. arabiensis* mosquitoes to volatiles from human bacteria was still significantly lower than the response of *An. gambiae* to these volatiles (Figure 1). In general, the behavioural response of *An. gambiae* and *An. arabiensis* to bacterial volatiles, closely resembled their response to the odours of these hosts (Busula *et al.*, 2015) indicating that bacterial volatiles may play an important role in their host selection. Follow up experiments in field setting where mosquitoes of different populations with different host preferences occur should further confirm the role of skin bacterial volatiles in host selection.

The experiment with individual bacterial species showed that the two mosquito species respond differently to volatiles from bacteria that are common on human and animal skin. *Anopheles gambiae* preferred volatiles from *C. minutissimum* to the volatiles from other bacterial species.

This preference may be explained by corynebacteria being the most abundant microbes on the human skin (Council *et al.*, 2016), especially on human feet (Wilson, 2008). These results closely match the results that were obtained in an olfactometer experiment with *An. coluzzii* and the same bacterial species grown *in vitro* (Verhulst *et al.*, 2010a). Verhulst *et al.* (2010a) also reported significantly higher responses of *An. coluzzii* to *C. minutissimum* and significantly lower responses to *P. aeruginosa*. In addition, in an *in vivo* experiment with 48 human volunteers, the increased attractiveness of certain individuals was associated with the

abundance of staphylococcus, while abundance of *Pseudomonas* species was associated with poorly attractive people (Verhulst *et al.*, 2011b). Corynebacteria were not significantly associated with attractiveness in this *in vivo* study.

*Anopheles arabiensis*, on the other hand, responded to the volatiles from all bacterial species tested without differentiation: in contrast to *An. gambiae*, it responded equally well to volatiles from *P. aeruginosa* as to the volatiles from the other bacterial species. Because *An. arabiensis* is more opportunistic than *An. gambiae*, it may find its host by using volatiles that are generally produced by skin bacteria. Previous volatile analysis of the four bacterial species tested in this study showed that one volatile chemical, butyl 2-methylbutanoate, was present in the headspace of all four bacterial species, including *P. aeruginosa* (Verhulst *et al.*, 2010a). This compound may therefore be utilized by opportunistic mosquitoes as a general skin bacterial cue to find their host. To confirm this and to find other common skin bacterial volatiles that mediate host preference, a next step would be to determine the volatile profiles of different groups of hosts by gas chromatography-mass spectrometry (GC-MS) and in addition define their bacterial profiles by 16S rRNA sequencing.

In this study, skin bacterial samples were taken from specific parts of the human, cow and chicken body, which will have influenced the bacterial composition of the samples (Grice *et al.*, 2009) and thereby the volatiles produced. The sampling places were chosen based on a previous study (Busula *et al.*, 2015), to be able to compare the results obtained with skin bacterial volatiles and volatiles collected directly from the skin. Although, the differences in attractiveness of volatiles released from different parts of the human body to *An. coluzzii* may be limited (Dekker *et al.*, 1998; Verhulst *et al.*, 2016), this may be different for other mosquito species and with volatiles from different animals. Nevertheless, differences between animal species are likely larger than within species and different body sites.

In conclusion, this study demonstrates that, in addition to *An. gambiae*, *An. arabiensis* also responds to skin bacterial volatiles. Both mosquito species can distinguish between volatiles from bacteria collected from different host species and respond differently to the volatiles from individual skin bacteria.

Current odour blends that attract host-seeking mosquitoes are specifically designed to attract anthropophilic mosquitoes such as *An. gambiae* and *An. funestus* (Mukabana *et al.*, 2012; Menger *et al.*, 2014; Mweresa *et al.*, 2014). Since targeting secondary vectors is becoming increasingly important as a result of changes in the malaria transmission landscape (Killeen, 2014), further identification of common bacterial volatiles would be an important step towards the development of a more general odour blend that attracts more opportunistic disease vectors, thereby reducing a broader range of potential vectors.

### **Acknowledgements**

David O. Alila and Elisha Kobudho are thanked for rearing and providing mosquitoes used in our experiments and Collins Mweresa and Faith Kyengo for logistical support. Elisha Kobudho and Solomon Ochieng are thanked for their help in collecting skin bacteria. Saskia Burgers is appreciated for statistical support. This study received financial support from the Earth and Life Sciences Foundation (Veni-ALW 863.13.012) and the Netherlands Organisation for Health Research and Development (TOP-grant ZonMW 91211038) of The Netherlands Organisation for Scientific Research (NWO). Annette O. Busula was hosted by *icipe*-TOC campus as a dissertation research internship scholar.

### **References**

- Bøgh, C., Clarke, S. E., Pinder, M., Sanyang, F. & Lindsay, S. W. (2001) Effect of passive zooprophylaxis on malaria transmission in The Gambia. *Journal of medical entomology*, **38**, 822-828.
- Braks, M. A. H. & Takken, W. (1999) Incubated human sweat but not fresh sweat attracts the malaria mosquito *Anopheles gambiae sensu stricto*. *Journal of Chemical Ecology*, **25**, 663-672.
- Busula, A., Takken, W., Loy, D., Hahn, B., Mukabana, W. & Verhulst, N. O. (2015) Mosquito host preferences affect their response to synthetic and natural odour blends. *Malaria Journal*, **14**, 133.
- Coetzee, M., Hunt, R. H. & Wilkerson, R. (2013) *Anopheles coluzzii* and *Anopheles amharicus*, new members of the *Anopheles gambiae* complex. *Zootaxa*, **3619**, 246-274.

- Costantini, C., Gibson, G., Sagnon, N., della Torre, A., Brady, J. & Coluzzi, M. (1996) Mosquito responses to carbon dioxide in a West African Sudan savanna village. *Medical and Veterinary Entomology*, **10**, 220-227.
- Costantini, C., Sagnon, N., della Torre, A. & Coluzzi, M. (1999) Mosquito behavioural aspects of vector-human interactions in the *Anopheles gambiae* complex. *Parassitologia*, **41**, 209-217.
- Council, S. E., Savage, A. M., Urban, J. M., Ehlers, M. E., Skene, J. H. P., Platt, M. L., Dunn, R. R. & Horvath, J. E. (2016) Diversity and evolution of the primate skin microbiome. *Proceedings of the Royal Society of London B: Biological Sciences*, **283**, 20152586.
- Dekker, T., Takken, W., Knols, B. G. J., Bouman, E., Laak, S., Bever, A. & Huisman, P. W. T. (1998) Selection of biting sites on a human host by *Anopheles gambiae* s.s., *An. arabiensis* and *An. quadriannulatus*. *Entomologia Experimentalis et Applicata*, **87**, 295-300.
- Gillies, M. T. (1964) Selection for host preference in *Anopheles gambiae*. *Nature*, **203**, 852-854.
- Githeko, A. K., Service, M. W., Mbogo, C. M., Atieli, F. K. & Juma, F. O. (1994) Origin of blood meals in indoor and outdoor resting malaria vectors in western Kenya. *Acta Tropica*, **58**, 307-316.
- Grice, E. A., Kong, H. H., Conlan, S., Deming, C. B., Davis, J., Young, A. C., NISC Comparative Sequencing Program, Bouffard, G. G., Blakesley, R. W., Murray, P. R., Green, E. D., *et al.* (2009) Topographical and temporal diversity of the human skin microbiome. *Science*, **324**, 1190-1192.
- Jaleta, K. T., Hill, S. R., Birgersson, G., Tekie, H. & Ignell, R. (2016) Chicken volatiles repel host-seeking malaria mosquitoes. *Malaria Journal*, **15**, 1.
- James, A. G., Casey, J., Hyliands, D. & Mycock, G. (2004) Fatty acid metabolism by cutaneous bacteria and its role in axillary malodour. *World Journal of Microbiology & Biotechnology*, **20**, 787.
- Killeen, G. F. (2014) Characterizing, controlling and eliminating residual malaria transmission. *Malaria journal*, **13**, 1.

- Knols, G. G. J. & Takken, W. (1997) Odour-mediated, host-seeking behaviour of *Anopheles* mosquitoes: a new approach. *Annals of Tropical Medicine and Parasitology*, **91**, 117-118.
- Lyimo, I. N., Haydon, D. T., Russell, T. L., Mbina, K. F., Daraja, A. A., Mbehela, E. M., Reeve, R. & Ferguson, H. M. (2013) The impact of host species and vector control measures on the fitness of African malaria vectors. *Proceedings of the Royal Society B: Biological Sciences*, **280**, 1-10.
- Mahande, A., Mosha, F., Mahande, J. & Kweka, E. (2007) Feeding and resting behaviour of malaria vector, *Anopheles arabiensis* with reference to zoophylaxis. *Malaria Journal*, **6**, 100.
- Meijerink, J., Braks, M. A. H., Brack, A. A., Adam, W., Dekker, T., Posthumus, M. A., Beek, T. A. v. & Loon, J. J. A. v. (2000) Identification of olfactory stimulants for *Anopheles gambiae* from human sweat samples. *Journal of Chemical Ecology*, **26**, 1367-1382.
- Menger, D., van Loon, J. & Takken, W. (2014) Assessing the efficacy of candidate mosquito repellents against the background of an attractive source that mimics a human host. *Medical and Veterinary Entomology*, **28**, 407-413.
- Mukabana, W. R., Mweresa, C. K., Otieno, B., Omusula, P., Smallegange, R. C., van Loon, J. J. A. & Takken, W. (2012) A novel synthetic odorant blend for trapping of malaria and other African mosquito species. *Journal of Chemical Ecology*, **38**, 235-244.
- Mutero, C. M., Kabutha, C., Kimani, V., Kabuage, L., Gitau, G., Ssenyonga, J., Githure, J., Muthami, L., Kaida, A., Musyoka, L., Marie, E., *et al.* (2004) A transdisciplinary perspective on the links between malaria and agroecosystems in Kenya. *Acta Tropica*, **89**, 171-186.
- Mweresa, C. K., Omusula, P., Otieno, B., Van Loon, J. J., Takken, W. & Mukabana, W. R. (2014) Molasses as a source of carbon dioxide for attracting the malaria mosquitoes *Anopheles gambiae* and *Anopheles funestus*. *Malaria Journal*, **13**, 160.
- Ndenga, B. A., Mulaya, N. L., Musaki, S. K., Shiroko, J. N., Dongus, S. & Fillinger, U. (2016) Malaria vectors and their blood-meal sources in an area of high bed net ownership in the western Kenya highlands. *Malaria Journal*, **15**, 1.
- Sachs, J. & Malaney, P. (2002) The economic and social burden of malaria. *Nature* **415**: 680-685.



- Sinka, M. E., Bangs, M. J., Manguin, S., Rubio-Palis, Y., Chareonviriyaphap, T., Coetzee, M., Mbogo, C. M., Hemingway, J., Patil, A. P. & Temperley, W. H. (2012) A global map of dominant malaria vectors. *Parasites & Vectors*, **5**, 1.
- Smallegange, R. C., Schmied, W., van Roey, K., Verhulst, N. O., Spitzen, J., Mukabana, W. & Takken, W. (2010) Sugar-fermenting yeast as an organic source of carbon dioxide to attract the malaria mosquito *Anopheles gambiae*. *Malaria Journal*, **9**, 292.
- Smallegange, R. C., Verhulst, N. O. & Takken, W. (2011) Sweaty skin: an invitation to bite? *Trends in Parasitology*, **27**, 143-148.
- Takken, W. & Verhulst, N. O. (2013) Host preferences of blood-feeding mosquitoes. *Annual Review of Entomology*, **58**, 433-453.
- Tirados, I., Costantini, C., Gibson, G. & Torr, S. J. (2006) Blood-feeding behaviour of the malarial mosquito *Anopheles arabiensis*: implications for vector control. *Medical and Veterinary Entomology*, **20**, 425-437.
- Tirados, I., Gibson, G., Young, S. & Torr, S. J. (2011) Are herders protected by their herds? An experimental analysis of zooprophyllaxis against the malaria vector *Anopheles arabiensis*. *Malaria journal*, **10**, 68.
- Verhulst, N. O., Andriessen, R., Groenhagen, U., Bukovinszkiné Kiss, G., Schulz, S., Takken, W., van Loon, J. J. A., Schraa, G. & Smallegange, R. C. (2010a) Differential attraction of malaria mosquitoes to volatile blends produced by human skin bacteria. *PLoS One*, **5**, e15829.
- Verhulst, N. O., Beijleveld, H., Knols, B. G. J., Takken, W., Schraa, G., Bouwmeester, H. J. & Smallegange, R. C. (2009) Cultured skin microbiota attracts malaria mosquitoes. *Malaria Journal*, **8**, 302.
- Verhulst, N. O., Loonen, J. A. C. M. & Takken, W. (2013) Advances in methods for colour marking of mosquitoes. *Parasites & Vectors*, **6**, 200.
- Verhulst, N. O., Mukabana, W. R., Takken, W. & Smallegange, R. C. (2011a) Human skin microbiota and their volatiles as odour baits for the malaria mosquito *Anopheles gambiae* s.s. *Entomologia Experimentalis et Applicata*, **139**, 170-179.
- Verhulst, N. O., Qiu, Y. T., Beijleveld, H., Maliepaard, C., Knights, D., Schulz, S., Berg-Lyons, D., Lauber, C. L., Verduijn, W., Haasnoot, G. W., Mumm, R., *et al.* (2011b)

- Composition of human skin microbiota affects attractiveness to malaria mosquitoes. *PLoS One*, **6**, e28991.
- Verhulst, N. O., Takken, W., Dicke, M., Schraa, G. & Smallegange, R. C. (2010b) Chemical ecology of interactions between human skin microbiota and mosquitoes. *FEMS Microbiology Ecology*, **74**, 1-9.
- Verhulst, N. O., Weldegergis, B. T., Menger, D. & Takken, W. (2016) Attractiveness of volatiles from different body parts to the malaria mosquito *Anopheles coluzzii* is affected by deodorant compounds. *Scientific reports*, **6**, 27141.
- WHO. (2015) World malaria report 2015. World Health Organisation, Geneva.
- Wilson, M. (2008) *Bacteriology of humans: an ecological perspective*. Blackwell Publishing Ltd, Malden, MA.

## Supplementary Figure and Tables

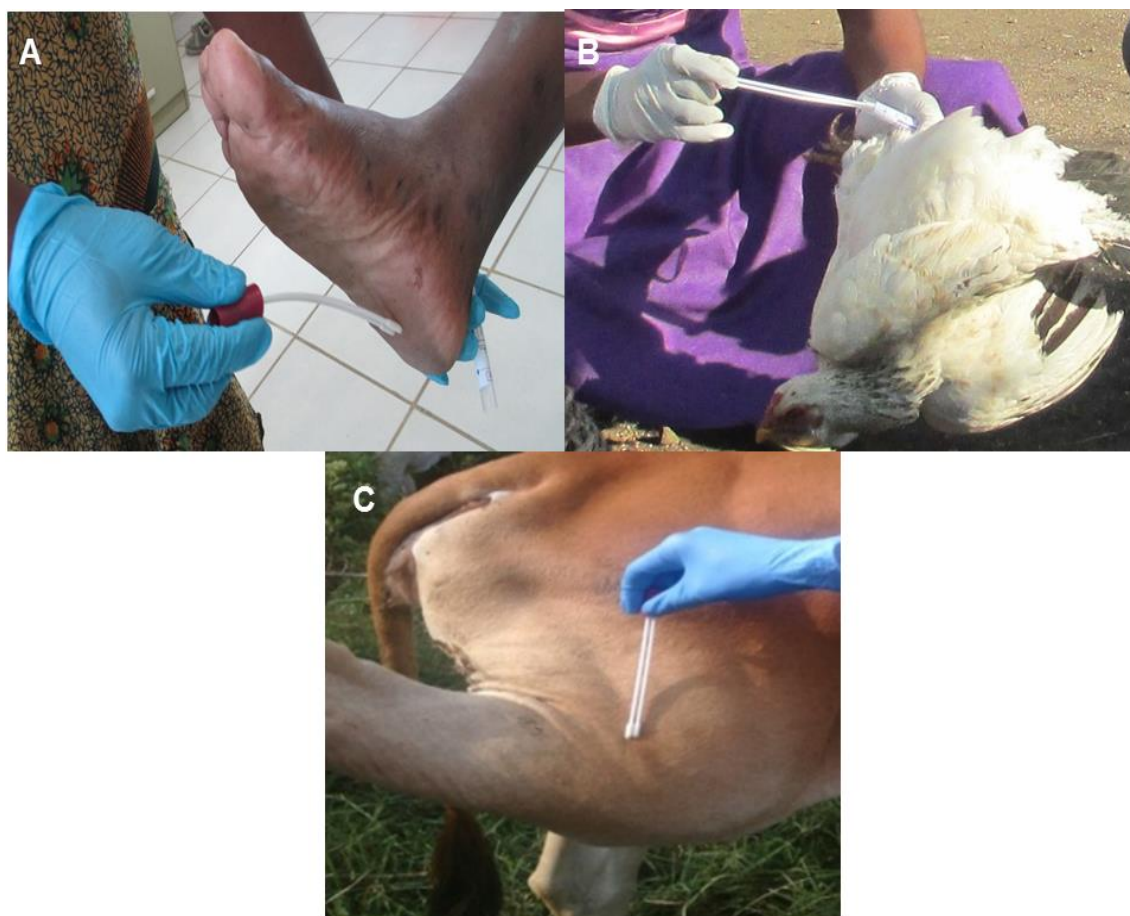

Figure 1: Collection of skin bacteria with dual tip cotton swab from A) human host, B) chicken and C) cow.

Table S1. Number of mosquitoes caught in traps baited with clean agar, skin bacteria from human, cow and chicken. Two hundred female mosquitoes of each species were released per night. Cfu's = colony forming units on the plates tested. N = number of trapping nights. SE= Standard error of the mean.

Treatment+CO <sub>2</sub>	N	Cfu's	Mean # caught ± SE	
			<i>An. gambiae</i>	<i>An. arabiensis</i>
Clean agar	16	0	10.8 ± 1.23	8.1 ± 1.14
Cow bacteria	16	134.1 ± 9.76	21.0 ± 1.63	23.6 ± 1.81
Chicken bacteria	16	117.5 ± 5.17	17.6 ± 1.70	22.9 ± 1.94
Human bacteria	16	133.0 ± 8.96	40.0 ± 1.30	33.6 ± 1.92

Table 2. Number of mosquitoes caught in a screen-house using MM-X traps baited with CO<sub>2</sub> and *S. epidermidis*, *P. aeruginosa*, *C. minutissimum* or *B. epidermidis*. Two hundred female mosquitoes of each species were released per night. N = number of trapping nights. SE= Standard error of the mean.

Treatment	N	Mean # caught ± SE	
		<i>An. gambiae</i>	<i>An. arabiensis</i>
<i>B. epidermidis</i>	16	16.7 ± 1.54	11.9 ± 2.2
<i>C. minutissimum</i>	16	23.1 ± 1.37	12.9 ± 1.59
<i>P. aeruginosa</i>	16	6.1 ± 0.54	13.0 ± 1.56
<i>S. epidermidis</i>	16	16.3 ± 1.01	12.4 ± 2.50



## Chapter 4

### Mechanisms of vertebrate-host manipulation by malaria parasites

Annette O. Busula, Niels O. Verhulst, Teun Bousema, Willem  
Takken and Jetske G. de Boer

To be submitted in a modified form

## **Abstract**

Vector-borne parasites can manipulate their hosts to enhance their transmission success, and this can occur directly through the vector as well as through the vertebrate host. Evidence is accumulating that infectious hosts are more attractive to *Plasmodium* vectoring mosquitoes than non-infected hosts. Host-seeking mosquitoes rely on volatile organic compounds, mediated by skin bacteria, to locate their blood-meal hosts, and changes in host odour have been suggested as a likely target for parasite manipulation. This review discusses potential mechanisms that may lead to changes in host odour, hence increased attractiveness upon *Plasmodium* infection. Two alternative routes are suggested, including direct emission of volatile products from malaria parasites, and changes in skin microbial composition that could lead to changes in the vertebrate odour profile. The specific role of gametocytes is discussed because high gametocyte densities may lead to increased attractiveness in humans, and since gametocyte density is also associated with increased mosquito infection rates, gametocyte-related attractiveness may amplify *Plasmodium* transmission from highly infectious individuals to mosquitoes. Such an effect of malaria manipulation on the transmission cycle could be particularly important in areas with hot spots of transmission, or in areas that are close to elimination of malaria.

## Introduction

The manipulation hypothesis states that parasites may manipulate their hosts to increase their transmission success and thereby fitness (Thomas *et al.*, 2005). Examples of parasite-host manipulation and the mechanisms involved are presented for *Toxoplasma gondii* and its rat host (Webster & McConkey, 2010) and hairworms and their terrestrial cricket host (Thomas *et al.*, 2002). In the former example, *Toxoplasma*-infected rats are attracted to the scent of cats, which are natural predators of rats, while non-infected rats avoid this scent (House *et al.*, 2011). Since *Toxoplasma* must undergo sexual reproduction in cats, the observed change in rat behaviour is an example of a parasite manipulating a mammalian host for its own benefit, because infected rats have a higher chance of falling prey to cats than non-infected rats. In the case of hairworms, crickets that harbour hairworms leave their terrestrial habitat to jump into water, unlike non-infected crickets, to allow immediate emergence of the worms after their hosts enter water. The ultimate goal of cricket manipulation is to improve parasite fitness, *i.e.* this behaviour increases the probability of the hairworms to reach a mating place (Thomas *et al.*, 2002). Other examples of manipulation are seen in *Trypanosome*-infected tsetse flies, which probe more frequently on vertebrate hosts than their non-infected counterparts (Roberts, 1981), thus increasing parasite transmission. Manipulation of mosquitoes by *Plasmodium* parasites, through direct effects in the mosquito, has been reviewed in detail (Koella *et al.*, 1998; Lefèvre & Thomas, 2008; Cator *et al.*, 2012) and will be briefly introduced below.

This review focuses on manipulation of malaria mosquitoes by *Plasmodium* parasites through effects on host attractiveness. We will discuss i) how *Plasmodium* parasites can benefit from manipulating mosquito vectors, and the fitness effects of parasites on the vector and vertebrate, ii) the effects of malaria parasites on the vertebrate host that may affect transmission through attractiveness to mosquitoes, including the potential role of clinical symptoms, developmental stage of the parasite, host age and immunity, and host odour profile, and iii) potential mechanisms of manipulation of host attractiveness by *Plasmodium* with emphasis on the role of microscopic gametocytes in mosquito attraction, mosquito attractive cues emitted by *Plasmodium*, and the role of skin bacteria in mediating



*Plasmodium*-induced changes in host odour. Possible consequences and opportunities of these findings for malaria control are discussed.

#### *Malaria lifecycle and benefits of manipulating vertebrate host and vector*

Malaria parasites depend on mosquito vectors to be transmitted from infected vertebrate hosts to healthy ones. During host-seeking, vectors take a blood meal with gametocytes, the sexual stages of the parasite, from infected hosts and the parasite undergoes sporogonic development in the vector (figure 1). After activation of male and female gametocytes in the midgut, a fertilized zygote develops into a motile ookinete that penetrates the mosquito midgut wall to form oocysts. These oocysts are first detectable after two days (Zollner *et al.*, 2006), they enlarge over time to release sporozoites by day 11-14, migrate to the salivary gland and render the mosquito infectious (Stone *et al.*, 2013).

In the period preceding sporozoite colonization of the salivary glands, the mosquito is not yet infectious and the malaria parasite depends on the survival of its mosquito host for successful transmission. During sporogonic development, mosquito behaviour changes to maximize the likelihood that the *Plasmodium* infection is successfully transmitted to the next vertebrate host. This may be achieved through reduced contact rate between mosquitoes and vertebrate hosts because blood-feeding and being blood-fed are associated with an increased mortality risk (Roitberg *et al.*, 2003; Seaman *et al.*, 2015). Infection of the vector by *Plasmodium* parasites at the oocyst stage indeed decreases the vector's motivation to bite (Anderson *et al.*, 1999). Interestingly, a recent study also showed that *P. falciparum*-infected vectors responded more strongly to odours from nectar at the oocyst stage than did non-infected mosquitoes of the same age (Nyasembe *et al.*, 2014). This manipulation of vector behaviour may benefit the parasite by ensuring survival of its vector, and hence its own survival, and development to the infectious stage and transmission. In contrast, at the transmissible sporozoite stage, infection with *Plasmodium* increases mosquito attraction to host odours, motivation to bite, landing and biting activity, blood meal size and biting frequency, hence increasing the chance that sporozoites are transmitted to new vertebrate hosts (Koella *et al.*, 1998; Ferguson & Read, 2002; Koella *et al.*, 2002; Cator *et al.*, 2013; Smallegange *et al.*, 2013).

The likelihood of successful transmission events by the infectious vector is thus enhanced by increased frequency of blood feeding or increased attraction to non-infected vertebrates. The cycle commences when the vector injects sporozoites into non-infected vertebrate hosts where the parasites develop until gametocytes form. Besides these direct effects of *Plasmodium* on mosquitoes, *Plasmodium* parasites may affect attractiveness of gametocyte-carrying vertebrate hosts to mosquito vectors (Hamilton & Hurd, 2002; Mukabana *et al.*, 2007), which is discussed in detail below.

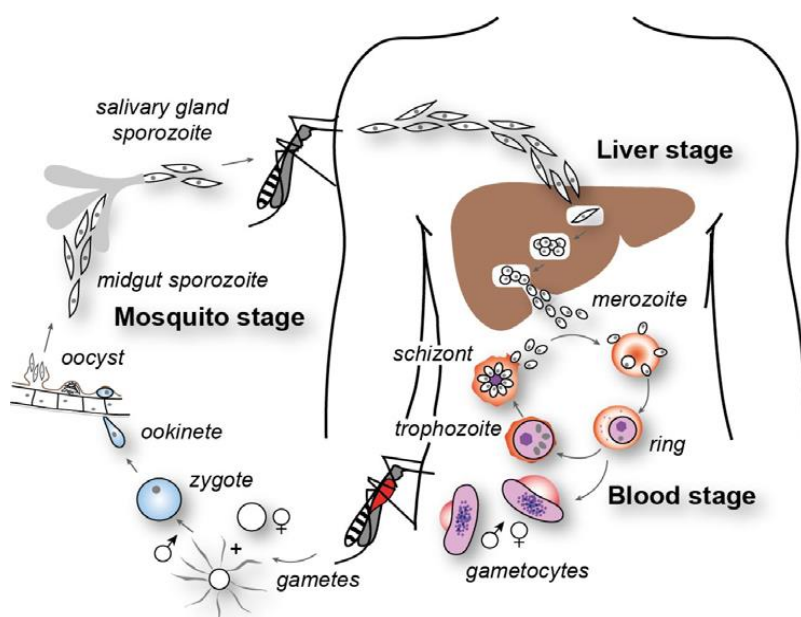

Figure 1. Life cycle of the malaria parasite *Plasmodium falciparum*. Female *Anopheles* mosquitoes pass *Plasmodium* sporozoites to a human when blood feeding, during which process the human becomes infected. Male and female gametocytes are the parasite stages taken up by female mosquitoes from the blood stream of infected hosts in order to mediate disease transmission. Source: (Cowman *et al.*, 2012).

### *Evolutionary signatures of malaria parasites in humans*

In order to understand how *Plasmodium* parasites may manipulate their vertebrate hosts, it is important to consider the fitness effects of *Plasmodium* on the vertebrate host as well as on the mosquito. *Plasmodium* infection often has negative effects on vertebrate fitness, e.g. birds or mammals may have a lower survival rate, either through direct pathological effects, or because they are more vulnerable to predation or secondary infections, although the level of fitness costs is dependent on the *Plasmodium* species (Lachish *et al.*, 2011).

Vertebrate hosts have evolved defence strategies against *Plasmodium* infection to reduce fitness costs, and humans are no exception. Their susceptibility to *Plasmodium* infection is influenced by genetic factors (Migot-Nabias *et al.*, 2000) that comprise many polymorphisms of red blood cells (RBCs), which provide shelter and nutrients to malaria parasites. Abnormal haemoglobin, changes in levels of key enzymes of the RBCs, and changes in physical structure of the RBC membrane (e.g. the Duffy blood group) partially protect humans from severe malaria (Bousema & Baidjoe, 2013). Haemoglobin S (HbS), a stable polymorphism in malaria-endemic regions, is associated with a reduced life expectancy among individuals who suffer from sickle cell disease, and an extended life expectancy of heterozygous individuals who are more likely to evade malaria (Haldane, 1949; Allison, 1954).

Glucose-6-phosphate dehydrogenase (G6PD) deficiency is an X-linked disorder of red blood cells in humans (Al-Joborae, 2015). In case of *Plasmodium* infection, G6PD deficient infected RBCs are phagocytized more efficiently than infected normal RBCs, leading to reduced parasite growth rates. Human leukocyte antigen (HLA) are also associated with changes in the susceptibility to severe malaria and parasitaemia, and play a significant role in the acquisition of immune responses (Hill *et al.*, 1992).

#### *Mosquito fitness and deceptive signalling*

It is also important to understand the effect of *Plasmodium* on vector fitness because the vector is essential for transmission of the parasite. Although some studies did not show significant reductions in mosquito survival or fecundity following *Plasmodium* infection (Ferguson & Read, 2002; Hien *et al.*, 2016), the infection can have negative effects on vector fitness. For example, Ferguson and Read (2002) found shorter lifespans in *An. stephensi* infected with *P. chabaudi* compared to non-infected mosquitoes. *Culex pipiens* infected with *P. Relictum* (Vézilier *et al.*, 2012) and *An. gambiae* s.l. infected with *P. falciparum* (Hogg & Hurd, 1997) also had significantly shorter lifespans than their non-infected counterparts. Additionally, significantly reduced reproductive fitness was reported in *Plasmodium*-infected *An. gambiae* s.s. and *An. stephensi* (Takken *et al.*, 2013). Moreover, *Plasmodium*-infected humans often have a decreased haematocrit, which is indeed negatively correlated with parasitaemia in vertebrate hosts (Nacher, 2002a). Hence, blood meals from infected hosts are

expected to be less nutritious and feeding mosquitoes on (non-infected) blood with a low haematocrit indeed reduced the long term survival of *An. gambiae* (Emami *et al.*, 2013).

In addition to direct effects of *Plasmodium*-infection on mosquitoes, ‘stage-dependant’ manipulation described above may reduce their fitness (Lefèvre & Thomas, 2008). Non-infected mosquitoes undergo the regular gonotrophic cycles, maximizing the number of offspring with the available resources (Takken *et al.*, 2013). In contrast, a reduction in mosquito offspring may be expected when they are *Plasmodium*-infected because the mosquito may avoid host-seeking during the oocyst stage, and will consequently go through fewer gonotrophic cycles than non-infected mosquitoes (Cator *et al.*, 2014).

Host, parasite and vector are constantly evolving to optimize their fitness. This means they are constantly adapting to each other; they co-evolve and are engaged in an ‘evolutionary arms-race’ (Dawkins & Krebs, 1979). If *Plasmodium*-infection indeed has a negative impact on mosquito fitness, mosquitoes are expected to evolve adaptations against taking blood meals from infectious vertebrate hosts, and/or to evolve a preference for biting non-infected hosts. It has been suggested that upregulation of existing host-seeking cues induced by *Plasmodium*-infection could deceive mosquito vectors and result in increased attractiveness of infected vertebrate hosts despite the negative fitness impact of feeding on infected hosts (Mauck *et al.*, 2010). The deceptive signalling hypothesis poses that counter-adaptations to upregulated cues that are important in host-seeking are less likely to evolve, compared to counter-adaptations to completely novel parasite-associated cues that do not play a role in host-seeking to healthy hosts.

### **Do clinical symptoms, host-age and immunity, and gametocytaemia influence malaria transmission?**

#### *Clinical symptoms of malaria*

In humans, *Plasmodium* parasites cause symptoms such as severe headache, nausea (vomiting), convulsions, and typical fever cycles. The period of relative normalcy in humans depends on the species of the infecting parasite. This interval is every 48 hours in the case of *P. vivax* and *P. ovale*, and every 72 hours in the case of *P. malariae*. *Plasmodium falciparum* does not usually cause a regular, cyclic fever (Nacher *et al.*, 2004). *Plasmodium ovale* and *P.*

*vivax*-infected patients may experience relapses over a period of months or years because parasite hypnozoites can be inactive in the liver during remission periods.

It has been suggested that the emergence of clinical symptoms could guide mosquitoes in host-seeking towards *Plasmodium*-infected humans (Nacher, 2005). The presence of fever and gametocytes in *P. vivax*-infected people increased short distance-host attractiveness to *An. darlingi* (Batista *et al.*, 2014). Fever could lead to increased sweat production, which may result in increased mosquito attraction (Katsuragawa *et al.*, 2010). A small study with two adult men as study participants suggested that malaria mosquitoes were not attracted to symptomatic *P. falciparum* carriers and that clinical malaria symptoms reduced their attractiveness to *An. gambiae* (Mukabana *et al.*, 2007).

Clinical symptoms of malaria are not directly correlated with the production of transmissible stages in *P. falciparum*-infected humans (McKenzie *et al.*, 2006; McKenzie *et al.*, 2007) and gametocytes may appear after symptoms have resolved, suggesting that it is unlikely that symptoms are induced by the parasite to increase its transmission success. In malaria-endemic regions, the majority of *Plasmodium* infections are asymptomatic or subclinical (Bousema *et al.*, 2014) due to the humoral immune response caused by repeated parasite exposure (Zoghi *et al.*, 2012). Despite the presence of malaria parasites, asymptomatic individuals do not show clinical symptoms and have an axillary temperature  $< 37.5^{\circ}\text{C}$  (Laishram *et al.*, 2012). Such infections can persist for several months when left untreated (Jeffery & Eyles, 1955; Roucher *et al.*, 2012), and when gametocytes are present, subclinical infections can contribute to *Plasmodium* transmission (Churcher *et al.*, 2013). Since most of the symptoms associated with malaria are not specific to this parasite but also occur with other infectious diseases, host-seeking mosquitoes are thus not expected to differentiate between *Plasmodium*-infected and non-infected hosts based on symptoms alone (Day & Edman, 1984).

#### *Host age and immunity*

In Sub-Saharan Africa, approximately 17% and 27% of the population ranges between 0–4 and 5–14 years, respectively, while 64% of the population consists of older children or adults

aged 15 years and above (Stone *et al.*, 2015). Children and infants harbour *Plasmodium* gametocytes more commonly and in greater numbers than adults (Stone *et al.*, 2015), and this decreases with age when immunity against asexual stages of *Plasmodium* parasites is acquired (Del Giudice *et al.*, 1990; Wipasa *et al.*, 2002; Ouédraogo *et al.*, 2010). Children are therefore thought to be the main source of infection for mosquitoes (Bonnet *et al.*, 2003) and they infect mosquitoes at a higher rate than adults (Drakeley *et al.*, 2006; Churcher *et al.*, 2013), thus contributing most to the total infectious reservoir. Infection with malaria parasites in children is correlated with their developing immune system; after repeated *Plasmodium*-infections, as they grow to adulthood, they acquire partial immunity, which is associated with an increase in asymptomatic *Plasmodium* infections.

Despite the larger contribution of children to the human infectious reservoir of *Plasmodium*, *Anopheles* biting preference among humans is thought to increase with age (Boreham *et al.*, 1978; Carnevale *et al.*, 1978; Port *et al.*, 1980). Mosquito biting preference could result from small differences in skin odour profile among adults and children (Gallagher *et al.*, 2008). These differences may be correlated with the maturation of sweat glands (Blackburn, 1991) and colonization by skin bacteria (Nordstrom & Noble, 1984), which results in a microbial shift on the skin of children when they reach puberty (Oh *et al.*, 2012). In addition, skin surface area and exposure to mosquitoes differ between children and adults, with children having a smaller skin surface and likely being less exposed during the times of the night when malaria mosquitoes are active (Stone *et al.*, 2015). Based on the differences between children and adults in gametocyte prevalence, mosquito biting preference and exposure to mosquitoes, we suggest that malaria parasites would benefit most from gametocyte-induced changes in attractiveness in children.

### *Gametocytaemia*

There is a density-dependent relationship between *Plasmodium* gametocytaemia and infectiousness of the human host to mosquitoes (Bousema *et al.*, 2014). Detection limits of gametocytes by microscopy are approximately 100 gametocytes/ $\mu$ l and such levels may lead to infection of over 20% of mosquitoes in membrane feeding assays (Churcher *et al.*, 2013). Lower levels of gametocytaemia are not detected by microscopy but can be detected by sensitive molecular methods, with detection limits as low as 0.01 gametocyte per microlitre

blood (Schneider *et al.*, 2004; Churcher *et al.*, 2013). These, so-called, sub-microscopic gametocyte carriers form an important part of the human infectious reservoir, infecting up to 4% of mosquitoes in membrane feeding assays (Churcher *et al.*, 2013; Stone *et al.*, 2015). Although the majority of gametocyte carriers harbour gametocytes below the microscopic detection limit (Stone *et al.*, 2015), manipulation by malaria parasites might be more beneficial at high levels of gametocytaemia because this leads to considerably higher infection rates in mosquitoes.

### ***Plasmodium*-mediated changes in host attractiveness**

Before a mosquito takes a blood meal, it must locate its vertebrate host by use of the developed sense organs, particularly olfaction (Takken & Knols, 1999; Lehane *et al.*, 2005). Host odour has therefore been suggested as a likely target of manipulation by malaria parasites (De Moraes *et al.*, 2014). Increased host attractiveness would directly increase the rate at which vectors encounter infected hosts, and consequently influence transmission. Evidence is accumulating that malaria parasites indeed manipulate their vertebrate hosts through host-seeking behaviour of *Plasmodium* vectors, which appear to be able to discriminate between infected and non-infected hosts. This phenomenon has been observed in a handful of choice experiments, including canaries (Cornet *et al.*, 2013a, 2013b), rodents (Ferguson & Read, 2004; De Moraes *et al.*, 2014) and humans (Lacroix *et al.*, 2005; Batista *et al.*, 2014, and Chapter 5).

In Cornet's studies (2013a,b), mosquitoes were given a choice between birds inoculated with *P. relictum* or non-infected birds. The results showed increased attractiveness of chronically infected birds to both sporozoite-infected and non-infected *Culex pipiens* mosquitoes (Cornet *et al.* 2013a, b). These findings suggest that, in this system, parasite manipulation could be stronger through the vertebrate host rather than through the vector, as both infected and non-infected mosquitoes had similar preference for infected birds. Mosquitoes did not differentiate between non-infected and infected birds during the acute phase, possibly as a result of lower haematocrit levels in acutely infected birds negating a positive effect of *Plasmodium* infection on attractiveness.

In a recent study on mice, both parasite and gametocyte densities were monitored in healthy and *P. chabaudi*-infected mice, at different stages throughout infection. The infection stages included: (i) the acute or symptomatic phase associated with poor response of mosquitoes to emitted volatiles, (ii) the chronic phase during which high gametocyte levels and significantly increased attraction of *Anopheles stephensi* mosquitoes were observed in infected and not in healthy mice, and (iii) the post-chronic stage correlated with low gametocyte levels and no preference of mosquitoes between the infected or healthy mice, despite of the distinct pattern in volatiles emitted by infected mice (De Moraes *et al.*, 2014). In this study, it is evident that gametocytes during the chronic stage influenced attractiveness of mice to mosquitoes. Interestingly, attraction of *An. stephensi* was low during acute infection despite the abundance of transmissible gametocytes, suggesting that symptoms may interfere with manipulation of host attractiveness rather than contribute to it.

Humans harbouring gametocytes were more attractive than parasite-free humans, to *An. darlingi* (Batista *et al.*, 2014) and to *An. gambiae* (Lacroix *et al.*, 2005, and Chapter 5). Batista tested attractiveness of feet of *P. vivax*-infected adults at three moments; when they were found with parasites, *i.e.* before treatment, seven days later (during antimalarial treatment), and 14 days later (after treatment). Patients were treated with an anti-malarial drug, primaquine, which clears gametocytes or renders them non-infectious in about 6-7 days (Butcher, 1997; Eziefula *et al.*, 2013). Attractiveness of three gametocyte carriers was increased compared to three infected patients without gametocytes, although the latter three likely harboured gametocytes that were not detected (McKenzie *et al.*, 2006; Wampfler *et al.*, 2013). Febrile participants with gametocytes were also found to be more attractive to *An. darlingi* than febrile participants without gametocytes, while no effect of gametocytes was found in non-febrile participants, suggesting that fever may play a role in this system. Although Batista's team found the gametocyte carriers to be more attractive to mosquitoes, they did not include control groups for their attractiveness during 14 days, *i.e.* non-infected (control) and asexual carriers, and the absence of gametocytes and parasites was not confirmed during the follow-up visits at days 7 and 14.



Lacroix' and Busula's studies involved whole body odour from parasite-free children or children naturally infected with asexual stage or sexual stage (gametocytes) *P. falciparum*. All children included in these studies were non-febrile and asymptomatic. Interestingly, both studies suggest that microscopic gametocytes alter human attractiveness, making gametocyte carriers approximately twice as attractive to *An. gambiae* compared to parasite-free children (Lacroix et. al 2005), Chapter 5). After antimalarial treatment, attractiveness of children was tested again and formerly infected children were found to be equally attractive to the other groups. Importantly, the attractiveness of *Plasmodium*-free children remained unchanged during the two phases (Chapter 5).

The study by Lacroix *et al.* (2005) has been criticized because *Plasmodium*-infected children were treated with sulfadoxine-pyrimethamine, which does not effectively clear gametocytes (Bousema *et al.*, 2003). Additionally, given the prevalence of sub-microscopic gametocytes in western Kenya, where Lacroix' study was conducted (Schneider *et al.*, 2006), it seems likely that a significant proportion of the included children with microscopic levels of asexual stages, or even children that were microscopically parasite-negative, actually harboured low levels of gametocytes. This thesis (Chapter 5) tested the attractiveness of PCR-negative as well as carriers of asexual stages, submicroscopic gametocyte or microscopic gametocyte carriers, and infected children were treated with artemisinin-lumefantrine combination therapy, a first line anti-malarial drug that kills all stages of malaria parasites (WHO, 2015). This was indeed confirmed by highly sensitive *Pfs25* mRNA QT-NASBA three weeks after antimalarial treatment, when the attractiveness of children was evaluated again.

While these studies demonstrate that mosquito behaviour is influenced by malaria parasites in vertebrate hosts, only one study has also analysed the odour profiles of infected and healthy hosts (see below) (De Moraes *et al.*, 2014). The mechanisms behind the attractiveness of *Plasmodium*-infected (gametocytes) humans have not been studied to date and need attention.

### **Mechanisms of parasite manipulation of host attractiveness**

Changes in host phenotype may result from chemical substances emitted by the parasite while in the host, or by emission of chemical substances from the host itself through the

action of the parasite. De Moraes et al. (2014) collected whole body volatiles from healthy and *Plasmodium* infected mice throughout different stages of infection. A reduction and an increase in volatile emissions during the acute and chronic stages of infection were shown, respectively, while similar levels of total emission in healthy and infected mice were reported during the post-chronic stage. A clear distinction in volatile blend composition was observed between the infected and healthy mice during the acute and chronic phases. Eleven compounds were associated with *Plasmodium* infection, including tridecane, N,N-dibutylformamide, 2-hexanone, 3-methyl-2-buten-1-ol, 3-methyl butanoic acid, 2-pyrrolidone, benzaldehyde and four unidentified compounds. Additionally, several volatile compounds that were produced in significantly higher amounts during the chronic stage of infection, which led to high levels of attraction to *An. stephensi*, were shown to mediate the host-seeking behaviour of these mosquitoes; hexanoic acid, 2- and 3-methyl butanoic acid and tridecane played a significant role in attractiveness of mosquitoes. Benzothiazole, which was present in lower amounts in chronically infected mice, also played a role in mosquito behaviour. In conclusion, the researchers clearly showed that the body odour profile of infected mice changes due to manipulation by *Plasmodium* parasites, but the mechanisms leading to these changes were not investigated. Here, we review two possible routes of manipulation of host odour by malaria parasites: direct emission of cues from *Plasmodium* and indirect manipulation through changes in skin microbial composition.

#### *Direct emission of cues from Plasmodium*

Host odour manipulation by *Plasmodium* could occur through direct emission of cues from malaria parasites. Kelly and colleagues found that *P. falciparum* cultures produce terpenes namely  $\alpha$ -pinene, limonene, 4,5,9,10-dehydroisolongifolene and its derivative 8,9-dehydro-9-formyl cycloisolongifolene (Kelly *et al.*, 2015). The identified terpenes may be used as volatile biomarkers of *Plasmodium* infection. From an evolutionary perspective, it is important to investigate whether *Plasmodium* gametocytes emit specific cues. However, the analysed cultures of *P. falciparum* existed largely of asexual stages, likely in combination with some gametocytes (Audrey Odom, personal communication), so this needs further investigation. It is also essential to investigate whether the cues produced by malaria parasites are emitted by the vertebrate host and thus available as host-seeking cues to mosquitoes.

Notably, no changes in terpene levels were observed in *Plasmodium*-infected mice (De Moraes *et al.*, 2014).

Additionally, in search of biomarkers for *Plasmodium* infection, a recent study did not report terpene emission from human breath as a result of *P. falciparum* infection (Berna *et al.*, 2015). Instead, the researchers identified a group of thioethers in human breath samples, namely (E)-1-methylthio-1-propene, ally methyl sulfide, (Z)-1-methylthio-1-propene, and 1-methylthio-propane. The thioethers are suspected to result from the association between non-gametocyaemic people and *P. falciparum*, and their levels were strongly correlated with parasitaemia. To our knowledge, thioethers have never been investigated as host-seeking cues for malaria mosquitoes. However, volatiles from human breath are thought not to increase mosquito attractiveness (Mukabana *et al.*, 2004; Olanga *et al.*, 2010). The role of terpenes in host-seeking behaviour of malaria mosquitoes is unclear. A recent field study showed that traps baited with limonene, *cis*-limonene oxide or *trans*-limonene oxide significantly reduced *An. arabiensis* catches compared to a negative control when traps were placed next to a human host sleeping under a bed net (Kassahun *et al.*, 2016). This suggests a negative effect of limonene and some of its derivatives in the host-seeking of *Plasmodium* vectors. Due to the difference in mosquito-physiological states (Foster & Takken, 2004), terpenes may be attractive to young *Anopheles* mosquitoes searching for nectar (Nyasembe *et al.*, 2012), while they could be repellent for host-seeking mosquitoes (Kassahun *et al.*, 2016). Despite of these findings, further investigations on whether mosquitoes use terpenes and thioethers in host-seeking is needed.

*Bacterial hypothesis: do skin microbiota mediate Plasmodium-induced changes in odour profile?*

Volatile organic chemicals (VOCs) are the principal host-seeking cues for malaria mosquitoes, and human skin volatiles associated with sweat are the key determinants in host preference of anthropophilic mosquitoes (Smallegange *et al.*, 2011). Skin bacteria are known to play an important role in human attractiveness, by converting components of sweat to attractive volatiles (Braks *et al.*, 1999; Verhulst *et al.*, 2009; Verhulst *et al.*, 2010; Verhulst *et al.*, 2011).

Verhulst *et al.* (2010) demonstrated that attractiveness to mosquitoes varies between different species of bacteria when grown *in vitro*. These findings were recently confirmed in a semi-field setting with *An. gambiae* (Chapter 3) and suggest that not all bacteria on the human skin produce volatiles attractive to *An. gambiae*. Skin microbial composition as well as bacterial abundance play important roles in attractiveness of human hosts (Verhulst *et al.*, 2011). Highly attractive persons had a significantly higher abundance but lower diversity of skin bacteria than poorly attractive persons. Interestingly, high levels of *Pseudomonas* spp. were associated with low levels of attractiveness, while high levels of *Staphylococcus* spp. were associated with high levels of attractiveness in healthy humans (Verhulst *et al.*, 2011).

Remarkably, De Moraes *et al.* (2014) identified elevated levels of volatiles of bacterial origin in *Plasmodium*-infected mice, and these were shown to increase attractiveness to *An. stephensi* when combined with the odour of healthy mice. The compounds include 2- and 3-methyl butanoic acid that are known to be emitted by *S. epidermidis*, and are also attractive to *An. gambiae* (Verhulst *et al.*, 2009; Verhulst *et al.*, 2011). Elsewhere, de Boer *et al.* (submitted) analysed human odour samples at three time periods throughout infection, *i.e.* before, during and after infection with malaria parasites. They identified three compounds that were associated with *Plasmodium*-infection and known to be produced by skin bacteria. The compounds include 2- and 3-methyl-butanal that were also found in the headspace of *S. epidermidis* and in a mixture of skin bacteria, and 3-hydroxy-2-butanone that was emitted by a mixture of skin bacteria (Verhulst *et al.*, 2009). These are important candidate compounds for mediating host-seeking behaviour of malaria mosquitoes to *Plasmodium*-infected humans because they are attractive to *An. gambiae* (Verhulst *et al.*, 2009), and support a potential role for skin microbes in mediating attractiveness of malaria infected hosts.

### **Conclusion and recommendations for future research**

Evidence is accumulating that gametocytes, and specifically high (microscopic) levels of gametocytes, lead to increased attractiveness of vertebrate hosts to vector mosquitoes. We have discussed two possible manipulation routes that may lead to changes in the vertebrate odour profile: (1) direct emission of volatile products from malaria parasites, and (2) indirect changes in volatile emission resulting from changes in the skin microbial profile (figure 2).

At present, there is no conclusive evidence for either route. An essential next step in addressing the mechanisms of *Plasmodium* manipulation would be to investigate odour and bacterial profiles of naturally infected, and gametocytaemic, humans. Such studies could lead to the identification of compounds that are influenced by *Plasmodium* infection and thereby give insight into how these changes occur.

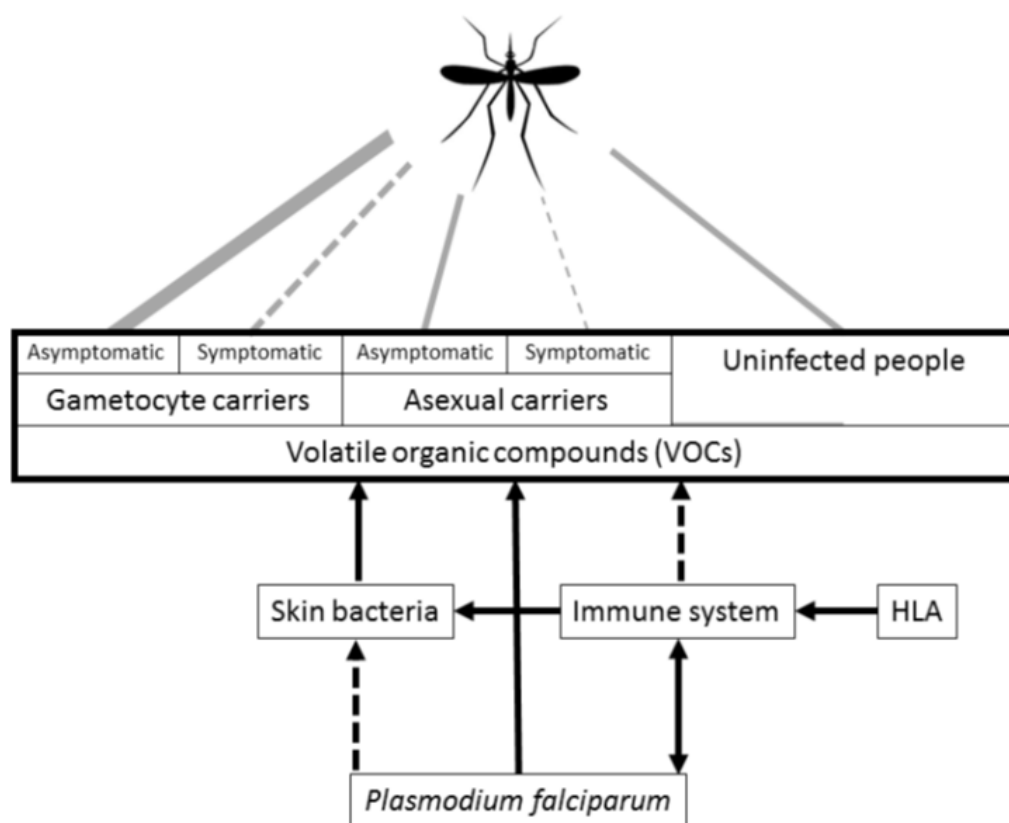

Figure 2. Factors that influence the production of VOCs from non-infected and *Plasmodium*-infected humans. Solid and broken lines represent known and unknown relationships, respectively. Attractiveness of mosquitoes to VOCs from people infected with different stages of *Plasmodium* is shown by the thickness of the grey lines.

Although emission of specific terpenes from *Plasmodium* cultures has been reported (Kelly *et al.*, 2015), terpenes were not detected in breath of *Plasmodium* infected humans and in whole body odour profiles of mice (De Moraes *et al.*, 2014; Berna *et al.*, 2015). Terpenes are typically produced by plants and known as sugar-searching cues for young *Anopheles* mosquitoes (Nyasembe *et al.*, 2012). Kelly *et al.* (2015) argue that the production of nectar-associated volatiles may be a strategy of *Plasmodium* parasites to overcome selection against

biting infected hosts. This would be an alternative to the deceptive signaling hypothesis, where upregulation of existing host-seeking cues is postulated to be the best strategy to minimize this selection pressure (Mauck *et al.*, 2010; De Moraes *et al.*, 2014). However, mosquito physiological status and age are known to play an important role in their olfactory behavior (Takken *et al.*, 1998; Foster & Takken, 2004), and limonene was recently shown to repel host-seeking mosquitoes (Kassahun *et al.*, 2016). It is thus unclear if and how terpenes may increase *Anopheles* responses to existing host-seeking cues. Moreover, it is not yet known whether emission of terpenes from malaria parasites is lifecycle specific. This may not be expected, given the function of the apicoplast in malaria parasite development in the vertebrate host (Stanway *et al.*, 2009), although differences in parasite metabolism at the asexual and gametocyte stage may still lead to distinct volatile emission (Audrey Odom, personal communication).

It may be unlikely that compounds emitted from *Plasmodium* directly influence host-seeking behaviour of mosquitoes, but they could indirectly alter the composition of host odour and hence mosquito attraction.

Penn and Potts (1998) suggested that infection with parasites can change the odour of an individual by changing the profile of commensal microbes. In this case, during infection, the activities of either the immunological and/or endocrine systems may be induced by parasite infection. This could also be the case when vertebrates are infected by malaria parasites, resulting in increased attractiveness of people who harbour gametocytes. High levels of attractiveness in healthy people are associated with high densities of *Staphylococcus* spp. (Verhulst *et al.*, 2011). This leads to the hypothesis that parasites alter the skin bacterial profile in such a way that gametocyte carriers harbour more *Staphylococcus* spp. than non-infected persons and persons with asexual stages. Additionally, or instead, gametocyte infections could lead to a reduction in densities of *Pseudomonas* spp., which are associated with poorly attractive healthy people (Verhulst *et al.*, 2011). Such a shift in skin microbial composition could lead to changes in volatile profiles, with increased levels of, for example, 2- and 3-methyl butanoic acid that were already identified in *Plasmodium*-infected mice (De Moraes *et al.* 2014), or 2- and 3 methyl-butanal, and 3-hydroxy-2-butanone, which were

found in volatiles of infected (although non-gametocytaemic) people (de Boer *et al.*, submitted). Research is thus needed to determine the composition of skin bacteria on gametocyte-positive individuals in comparison with healthy individuals or those infected with asexual stages. This could be done by 16S-rRNA sequencing of the skin microbiome (Costello *et al.*, 2009; Peterson *et al.*, 2009; Kong, 2011; Verhulst *et al.*, 2011).

Interestingly, microbial communities on children's skin shift as they grow to adulthood such that more diverse microbiota can be found on their skin than on adults' skin (Oh *et al.*, 2012). This shift may be due to maturation of the immune system, supporting a potential effect of the immune system on the skin microbiome. Even small changes in skin-lipids are sufficient to drive colonization of bacteria (Oh *et al.*, 2012), and shifts in skin microbiota can occur rapidly (within eight hours) in replacement studies (Costello *et al.*, 2009). The role of skin microbiota in mediating *Plasmodium*-induced changes in vertebrate attractiveness seems plausible but remains to be established. If an association between *Plasmodium*-infection, skin microbiome and attractiveness can be shown, this leads to new questions. How do gametocytes specifically induce changes in the skin microbiome? Addressing this question requires a detailed understanding of the effects of malaria-gametocytes on the human immune system (Stone *et al.*, 2016). Additionally, the dynamics of gametocytaemia in *Plasmodium* species are known to differ (McKenzie *et al.*, 2007), with *P. vivax* gametocytes being produced during every multiplication cycle and those of *P. Malariae* being more irregular (McKenzie *et al.*, 2001). Such differences may also have implications on the mechanisms of vertebrate host manipulation, particularly on the relative roles of gametocyte and asexual stages. Further studies are also necessary to understand whether *Plasmodium*-induced attractiveness is also mediated by the skin microbiome in non-human systems.

This is of particular interest because the role of skin bacteria in host-seeking of mosquito vectors has only been established for two *Anopheles* species (Chapter 3), and different host-seeking cues might be more important in other mosquito species, such as *Culex quinquefasciatus*, that transmit non-human malaria parasites (Puri *et al.*, 2006). Finally, it will be important to examine how co-infections with other parasites or pathogens influence manipulation of vertebrate odour profiles by *Plasmodium* parasites. Such co-infections are

very common in malaria-endemic areas, with *Plasmodium* infections often co-occurring with helminth infections or the human immune deficiency virus (Nacher, 2002b). Because these other infections also influence the immune system, studying malaria-parasite manipulation in co-infected individuals will not only be more representative of a natural setting but also be informative on the role of the immune system in the mechanisms of *Plasmodium* manipulation.

Now that several mosquito behavioural studies provided convincing evidence for host manipulation by *Plasmodium* parasites, it is time to further investigate the mechanisms behind malaria-parasite manipulation. Future studies on this topic will not only lead to better understanding of why mosquitoes prefer volatiles from gametocyte-carriers, but may also lead to novel tools that intervene in this manipulation.

## References

- Al-Joborae, S. F. F. M. (2015) Extent of knowledge of mothers of neonates with G6PD deficiency in Hilla City. *Journal of Babylon University/Pure and Applied Sciences*,**23**, 1-9.
- Allison, A. C. (1954) The distribution of the sickle-cell trait in East Africa and elsewhere, and its apparent relationship to the incidence of subtertian malaria. *Transactions of the Royal Society of Tropical Medicine and Hygiene*,**48**, 312-318.
- Anderson, R. A., Koellaf, J. & Hurd, H. (1999) The effect of *Plasmodium yoelii nigeriensis* infection on the feeding persistence of *Anopheles stephensi* Liston throughout the sporogonic cycle. *Proceedings of the Royal Society of London B: Biological Sciences*,**266**, 1729-1733.
- Batista, E. P. A., Costa, E. F. M. & Silva, A. A. (2014) *Anopheles darlingi* (Diptera: Culicidae) displays increased attractiveness to infected individuals with *Plasmodium vivax* gametocytes. *Parasites & Vectors*,**7**.
- Berna, A. Z., McCarthy, J. S., Wang, R. X., Saliba, K. J., Bravo, F. G., Cassells, J., *et al.* (2015) Analysis of breath specimens for biomarkers of *Plasmodium falciparum* infection. *Journal of Infectious Diseases*,**212**, 1120-1128.



- Blackburn, D. G. (1991) Evolutionary origins of the mammary gland. *Mammal Review*,**21**, 81-96.
- Bonnet, S., Gouagna, L., Paul, R., Safeukui, I., Meunier, J.-Y. & Boudin, C. (2003) Estimation of malaria transmission from humans to mosquitoes in two neighbouring villages in south Cameroon: evaluation and comparison of several indices. *Transactions of the Royal Society of Tropical Medicine and Hygiene*,**97**, 53-59.
- Boreham, P., Chandler, J. & Jolly, J. (1978) The incidence of mosquitoes feeding on mothers and babies at Kisumu, Kenya. *Journal of Tropical Medicine and Hygiene*,**81**, 63-67.
- Bousema, Okell, L., Felger, I. & Drakeley, C. (2014) Asymptomatic malaria infections: detectability, transmissibility and public health relevance. *Nature Reviews Microbiology*,**12**, 833-840.
- Bousema, J., Gouagna, L., Meutstege, A., Okech, B., Akim, N., Githure, J., *et al.* (2003) Treatment failure of pyrimethamine-sulphadoxine and induction of *Plasmodium falciparum* gametocytaemia in children in western Kenya. *Tropical Medicine & International Health*,**8**, 427-430.
- Bousema, T. & Baidjoe, A. (2013) Heterogeneity in malaria transmission: underlying factors and implications for disease control. In *Ecology of parasite-vector interactions*, pp. 197-220. Wageningen Academic Publishers, Wageningen.
- Braks, M., Anderson, R. & Knols, B. (1999) Infochemicals in mosquito host selection: human skin microflora and *Plasmodium* parasites. *Parasitology Today*,**15**, 409-413.
- Butcher, G. A. (1997) Antimalarial drugs and the mosquito transmission of *Plasmodium*. *International Journal for Parasitology*,**27**, 975-987.
- Carnevale, P., Frézil, J.-L., Bosseno, M.-F., Le Pont, F. & Lancien, J. (1978) Etude de l'agressivité *D'Anopheles gambiae* A en fonction de l'âge et du sexe des sujets humains. *Bulletin of the World Health Organization*,**56**, 147.
- Cator, L. J., George, J., Blanford, S., Murdock, C. C., Baker, T. C., Read, A. F., *et al.* (2013) 'Manipulation' without the parasite: altered feeding behaviour of mosquitoes is not dependent on infection with malaria parasites. *Proceedings of the Royal Society B-Biological Sciences*,**280**.
- Cator, L. J., Lynch, P. A., Read, A. F. & Thomas, M. B. (2012) Do malaria parasites manipulate mosquitoes? *Trends in Parasitology*,**28**, 466-470.

- Cator, L. J., Lynch, P. A., Thomas, M. B. & Read, A. F. (2014) Alterations in mosquito behaviour by malaria parasites: potential impact on force of infection. *Malaria Journal*,**13**.
- Churcher, T. S., Bousema, T., Walker, M., Drakeley, C., Schneider, P., Ouedraogo, A. L., *et al.* (2013) Predicting mosquito infection from *Plasmodium falciparum* gametocyte density and estimating the reservoir of infection. *Elife*,**2**.
- Cornet, S., Nicot, A., Rivero, A. & Gandon, S. (2013a) Both infected and uninfected mosquitoes are attracted toward malaria infected birds. *Malaria Journal*,**12**.
- Cornet, S., Nicot, A., Rivero, A. & Gandon, S. (2013b) Malaria infection increases bird attractiveness to uninfected mosquitoes. *Ecology Letters*,**16**, 323-329.
- Costello, E. K., Lauber, C. L., Hamady, M., Fierer, N., Gordon, J. I. & Knight, R. (2009) Bacterial community variation in human body habitats across space and time. *Science*,**326**, 1694-1697.
- Cowman, A. F., Berry, D. & Baum, J. (2012) The cellular and molecular basis for malaria parasite invasion of the human red blood cell. *Journal of Cell Biology*,**198**, 961-971.
- Dawkins, R. & Krebs, J. R. (1979) Arms races between and within species. *Proceedings of the Royal Society of London B: Biological Sciences*,**205**, 489-511.
- Day, J. F. & Edman, J. D. (1984) The importance of disease induced changes in mammalian body temperature to mosquito blood feeding. *Comparative Biochemistry and Physiology Part A: Physiology*,**77**, 447-452.
- de Boer, J. G., Robinson, A., Powers, S. J., Burgers, S. L. G. E., Caulfield, J. C., Birkett, M. A., *et al.* (submitted) Odours of *Plasmodium falciparum*-infected participants influence mosquito-host interactions *Scientific Reports*.
- De Moraes, C. M., Stanczyk, N. M., Betz, H. S., Pulido, H., Sim, D. G., Read, A. F., *et al.* (2014) Malaria-induced changes in host odors enhance mosquito attraction. *Proceedings of the National Academy of Sciences of the United States of America*,**111**, 11079-11084.
- Del Giudice, G., Lambert, P., Mendis, K., Pessi, A. & Tanner, M. (1990) Antibody responses to *Plasmodium falciparum* and *P. vivax* sporozoites in areas with stable and unstable malaria. *Bulletin of the World Health Organization*,**68**, 191.

- Drakeley, C., Sutherland, C., Bousema, J. T., Sauerwein, R. W. & Targett, G. A. (2006) The epidemiology of *Plasmodium falciparum* gametocytes: weapons of mass dispersion. *Trends in Parasitology*, **22**, 424-430.
- Emami, S. N., Ranford-Cartwright, L. C. & Ferguson, H. M. (2013) The impact of low erythrocyte density in human blood on the fitness and energetic reserves of the African malaria vector *Anopheles gambiae*. *Malaria Journal*, **12**.
- Eziefule, A. C., Staedke, S. G., Yeung, S., Webb, E., Kamya, M., White, N. J., *et al.* (2013) Study protocol for a randomised controlled double-blinded trial of the dose-dependent efficacy and safety of primaquine for clearance of gametocytes in children with uncomplicated *falciparum* malaria in Uganda. *BMJ open*, **3**, e002759.
- Ferguson & Read, A. (2002) Genetic and environmental determinants of malaria parasite virulence in mosquitoes. *Proceedings of the Royal Society of London B: Biological Sciences*, **269**, 1217-1224.
- Ferguson, H. M. & Read, A. F. (2004) Mosquito appetite for blood is stimulated by *Plasmodium chabaudi* infections in themselves and their vertebrate hosts. *Malaria Journal*, **3**.
- Foster, W. & Takken, W. (2004) Nectar-related versus human-related volatiles: behavioural response and choice by female and male *Anopheles gambiae* (Diptera: Culicidae) between emergence and first feeding. *Bulletin of Entomological Research*, **94**, 145-157.
- Gallagher, M., Wysocki, C., Leyden, J., Spielman, A., Sun, X. & Preti, G. (2008) Analyses of volatile organic compounds from human skin. *British Journal of Dermatology*, **159**, 780-791.
- Haldane, J. S. (1949) The rate of mutation of human genes. *Hereditas*, **35**, 267-273.
- Hamilton, J. & Hurd, H. (2002) Parasite manipulation of vector behaviour. *The Behavioural Ecology of Parasites*, 259-281.
- Hien, D. F. d. S., Dabiré, K. R., Roche, B., Diabaté, A., Yerbanga, R. S., Cohuet, A., *et al.* (2016) Plant-mediated effects on mosquito capacity to transmit human malaria. *PLoS Pathology*, **12**, e1005773.

- Hill, A. V., Elvin, J., Willis, A. C., Aidoo, M., Allsopp, C. E., Gotch, F. M., *et al.* (1992) Molecular analysis of the association of HLA-B53 and resistance to severe malaria. *Nature* **360**, 434-439.
- Hogg, J. C. & Hurd, H. (1997) The effects of natural *Plasmodium falciparum* infection on the fecundity and mortality of *Anopheles gambiae s.l.* in north east Tanzania. *Parasitology*, **114**, 325-331.
- House, P. K., Vyas, A. & Sapolsky, R. (2011) Predator cat odors activate sexual arousal pathways in brains of *Toxoplasma gondii* infected rats. *PLoS One*, **6**, e23277.
- Jeffery, G. M. & Eyles, D. E. (1955) Infectivity to Mosquitoes of *Plasmodium falciparum* as related to gametocyte density and duration of Infection. *American Journal of Tropical Medicine and Hygiene*, **4**, 781-789.
- Kassahun, T., Hill, R., Birgersson, G., Tekie, H. & Ignell, R. (2016) Chicken volatiles repel host-seeking malaria mosquitoes. *Malaria Journal*, **15**:354.
- Katsuragawa, T. H., Gil, L. H. S., Tada, M. S., e Silva, A. d. A., Costa, J. D. A. N., da Silva Araújo, M., *et al.* (2010) The dynamics of transmission and spatial distribution of malaria in riverside areas of Porto Velho, Rondônia, in the Amazon region of Brazil. *PLoS One*, **5**, e9245.
- Kelly, M., Su, C. Y., Schaber, C., Crowley, J. R., Hsu, F. F., Carlson, J. R., *et al.* (2015) Malaria parasites produce volatile mosquito attractants. *Mbio*, **6**.
- Koella, J. C., Rieu, L. & Paul, R. E. (2002) Stage-specific manipulation of a mosquito's host-seeking behavior by the malaria parasite *Plasmodium gallinaceum*. *Behavioral Ecology*, **13**, 816-820.
- Koella, J. C., Sörensen, F. L. & Anderson, R. (1998) The malaria parasite, *Plasmodium falciparum*, increases the frequency of multiple feeding of its mosquito vector, *Anopheles gambiae*. *Proceedings of the Royal Society of London B: Biological Sciences*, **265**, 763-768.
- Kong, H. H. (2011) Skin microbiome: genomics-based insights into the diversity and role of skin microbes. *Trends in Molecular Medicine*, **17**, 320-328.
- Lachish, S., Knowles, S. C., Alves, R., Wood, M. J. & Sheldon, B. C. (2011) Infection dynamics of endemic malaria in a wild bird population: parasite species-dependent

- drivers of spatial and temporal variation in transmission rates. *Journal of Animal Ecology*, **80**, 1207-1216.
- Lacroix, R., Mukabana, W. R., Gouagna, L. C. & Koella, J. C. (2005) Malaria infection increases attractiveness of humans to mosquitoes. *Plos Biology*, **3**, 1590-1593.
- Laishram, D. D., Sutton, P. L., Nanda, N., Sharma, V. L., Sobti, R. C., Carlton, J. M., *et al.* (2012) The complexities of malaria disease manifestations with a focus on asymptomatic malaria. *Malaria Journal*, **11**, 1.
- Lefèvre, T. & Thomas, F. (2008) Behind the scene, something else is pulling the strings: emphasizing parasitic manipulation in vector-borne diseases. *Infection, Genetics and Evolution*, **8**, 504-519.
- Lehane, B., Schneider, J. & Xu, X. (2005) The UWA-05 method for prediction of axial capacity of driven piles in sand. *Frontiers in Offshore Geotechnics: ISFOG*, 683-689.
- Mauck, K. E., De Moraes, C. M. & Mescher, M. C. (2010) Deceptive chemical signals induced by a plant virus attract insect vectors to inferior hosts. *Proceedings of the National Academy of Sciences of the United States of America*, **107**, 3600-3605.
- McKenzie, E. F., Jeffery, G. M. & Williams, C. E. (2001) *Plasmodium malariae* blood-stage dynamics. *Journal of Parasitology*, **87**, 626-637.
- McKenzie, F. E., Jeffery, G. M. & Collins, W. E. (2007) Gametocytemia and fever in human malaria infections. *Journal of Parasitology*, **93**, 627-633.
- McKenzie, F. E., Wongsrichanalai, C., Magill, A. J., Forney, J. R., Permpanich, B., Lucas, C., *et al.* (2006) Gametocytemia in *Plasmodium vivax* and *Plasmodium falciparum* infections. *Journal of Parasitology*, **92**, 1281-1285.
- Migot-Nabias, F., Mombo, L., Luty, A., Dubois, B., Nabias, R., Bisseye, C., *et al.* (2000) Human genetic factors related to susceptibility to mild malaria in Gabon. *Genes and Immunity*, **1**, 435-441.
- Mukabana, W. R., Takken, W., Killeen, G. F. & Knols, B. G. J. (2004) Allomonal effect of breath contributes to differential attractiveness of humans to the African malaria vector *Anopheles gambiae*. *Malaria Journal*, **3**.
- Mukabana, W. R., Takken, W., Killeen, G. F. & Knols, B. G. J. (2007) Clinical malaria reduces human attractiveness to mosquitoes. *Proceedings of the Netherlands Entomological Society Meeting*, **18**, 125-129.

- Nacher, M. (2002a) Malarial anaemia: a crossroad? *Medical Hypotheses*,**59**, 363-365.
- Nacher, M. (2002b) Worms and malaria: noisy nuisances and silent benefits. *Parasite Immunology*,**24**, 391-393.
- Nacher, M. (2005) Charming the mosquito: do malaria symptoms increase the attractiveness of the host for the vector? *Medical Hypotheses*,**64**, 788-791.
- Nacher, M., Carrara, V. I., Ashley, E., McGready, R., Hutagalung, R., Nguen, J. V., *et al.* (2004) Seasonal variation in hyperparasitaemia and gametocyte carriage in patients with *Plasmodium falciparum* malaria on the Thai–Burmese border. *Transactions of the Royal Society of Tropical Medicine and Hygiene*,**98**, 322-328.
- Nordstrom, N. & Noble, W. (1984) Colonization of the axilla by *Propionibacterium avidum* in relation to age. *Applied and Environmental Microbiology*,**47**, 1360-1362.
- Nyasembe, V. O., Teal, P. E., Mukabana, W. R., Tumlinson, J. H. & Torto, B. (2012) Behavioural response of the malaria vector *Anopheles gambiae* to host plant volatiles and synthetic blends. *Parasites and Vectors*,**5**, 234.
- Nyasembe, V. O., Teal, P. E., Sawa, P., Tumlinson, J. H., Borgemeister, C. & Torto, B. (2014) *Plasmodium falciparum* infection increases *Anopheles gambiae* attraction to nectar sources and sugar uptake. *Current Biology*,**24**, 217-221.
- Oh, J., Conlan, S., Polley, E. C., Segre, J. A. & Kong, H. H. (2012) Shifts in human skin and nares microbiota of healthy children and adults. *Genome Medicine*,**4**, 1-11.
- Olanga, E. A., Okal, M. N., Mbadi, P. A., Kokwaro, E. D. & Mukabana, W. R. (2010) Attraction of *Anopheles gambiae* to odour baits augmented with heat and moisture. *Malaria Journal*,**9**.
- Ouédraogo, A. L., Bousema, T., de Vlas, S. J., Cuzin-Ouattara, N., Verhave, J.-P., Drakeley, C., *et al.* (2010) The plasticity of *Plasmodium falciparum* gametocytaemia in relation to age in Burkina Faso. *Malaria Journal*,**9**, 1.
- Penn, D. & Potts, W. (1998) How do major histocompatibility complex genes influence odor and mating preferences. *Advanced Immunology*,**69**, 411-436.
- Peterson, J., Garges, S., Giovanni, M., McInnes, P., Wang, L., Schloss, J. A., *et al.* (2009) The NIH Human Microbiome Project. *Genome Research*,**19**, 2317-2323.

- Port, G., Boreham, P. & Bryan, J. H. (1980) The relationship of host size to feeding by mosquitoes of the *Anopheles gambiae* Giles complex (Diptera: Culicidae). *Bulletin of Entomological Research*, **70**, 133-144.
- Puri, S. N., Mendki, M., Sukumaran, D., Ganesan, K., Prakash, S. & Sekhar, K. (2006) Electroantennogram and behavioral responses of *Culex quinquefasciatus* (Diptera: Culicidae) females to chemicals found in human skin emanations. *Journal of Medical Entomology*, **43**, 207-213.
- Roberts, L. W. (1981) Probing by *Glossina morsitans morsitans* and transmission of *Trypanosoma* (Nannomonas) *congolense*. *American Journal of Tropical Medicine and Hygiene*, **30**, 948-951.
- Roitberg, B. D., Mondor, E. B. & Tyerman, J. G. (2003) Pouncing spider, flying mosquito: blood acquisition increases predation risk in mosquitoes. *Behavioral Ecology*, **14**, 736-740.
- Roucher, C., Rogier, C., Dieye-Ba, F., Sokhna, C., Tall, A. & Trape, J.-F. (2012) Changing malaria epidemiology and diagnostic criteria for *Plasmodium falciparum* clinical malaria. *PloS One*, **7**, e46188.
- Schneider, P., Bousema, T., Omar, S., Gouagna, L., Sawa, P., Schallig, H., *et al.* (2006) (Sub)microscopic *Plasmodium falciparum* gametocytaemia in Kenyan children after treatment with sulphadoxine-pyrimethamine monotherapy or in combination with artesunate. *International Journal for Parasitology*, **36**, 403-408.
- Schneider, P., Schoone, G., Schallig, H., Verhage, D., Telgt, D., Eling, W., *et al.* (2004) Quantification of *Plasmodium falciparum* gametocytes in differential stages of development by quantitative nucleic acid sequence-based amplification. *Molecular and Biochemical Parasitology*, **137**, 35-41.
- Seaman, J. A., Alout, H., Meyers, J. I., Stenglein, M. D., Dabiré, R. K., Lozano-Fuentes, S., *et al.* (2015) Age and prior blood feeding of *Anopheles gambiae* influences their susceptibility and gene expression patterns to ivermectin-containing blood meals. *BMC Genomics*, **16**, 1.
- Smallegange, R. C., van Gemert, G. J., van de Vegte-Bolmer, M., Gezan, S., Takken, W., Sauerwein, R. W., *et al.* (2013) Malaria infected mosquitoes express enhanced attraction to human odor. *Plos One*, **8**.

- Smallegange, R. C., Verhulst, N. O. & Takken, W. (2011) Sweaty skin: an invitation to bite? *Trends in Parasitology*,**27**, 143-148.
- Stanway, R. R., Witt, T., Zobiak, B., Aepfelbacher, M. & Heussler, V. T. (2009) GFP-targeting allows visualization of the apicoplast throughout the life cycle of live malaria parasites. *Biology of the Cell*,**101**, 415-435.
- Stone, W., Gonçalves, B. P., Bousema, T. & Drakeley, C. (2015) Assessing the infectious reservoir of *falciparum* malaria: past and future. *Trends in Parasitology*,**31**, 287-296.
- Stone, W. J., Dantzer, K. W., Nilsson, S. K., Drakeley, C. J., Marti, M., Bousema, T., *et al.* (2016) Naturally acquired immunity to sexual stage *P. falciparum* parasites. *Parasitology*,**1**, 1-12.
- Stone, W. J., Eldering, M., van Gemert, G.-J., Lanke, K. H., Grignard, L., van de Vegte-Bolmer, M. G., *et al.* (2013) The relevance and applicability of oocyst prevalence as a read-out for mosquito feeding assays. *Scientific Reports*,**3**, 3418.
- Takken, W., Klowden, M. J. & Chambers, G. M. (1998) Effect of body size on host seeking and blood meal utilization in *Anopheles gambiae sensu stricto* (Diptera : Culicidae): The disadvantage of being small. *Journal of Medical Entomology*,**35**, 639-645.
- Takken, W. & Knols, B. G. (1999) Odor-mediated behavior of Afrotropical malaria mosquitoes. *Annual Review of Entomology*,**44**, 131-157.
- Takken, W., Smallegange, R. C., Vigneau, A. J., Johnston, V., Brown, M., Mordue-Luntz, A. J., *et al.* (2013) Larval nutrition differentially affects adult fitness and *Plasmodium* development in the malaria vectors *Anopheles gambiae* and *Anopheles stephensi*. *Parasites & Vectors*,**6**, 345.
- Thomas, F., Adamo, S. & Moore, J. (2005) Parasitic manipulation: where are we and where should we go? *Behavioural Processes*,**68**, 185-199.
- Thomas, F., Schmidt-Rhaesa, A., Martin, G., Manu, C., Durand, P. & Renaud, F. (2002) Do hairworms (Nematomorpha) manipulate the water seeking behaviour of their terrestrial hosts? *Journal of Evolutionary Biology*,**15**, 356-361.
- Verhulst, N. O., Beijleveld, H., Knols, B. G. J., Takken, W., Schraa, G., Bouwmeester, H. J., *et al.* (2009) Cultured skin microbiota attracts malaria mosquitoes. *Malaria Journal*,**8**.



- Verhulst, N. O., Qiu, Y. T., Beijleveld, H., Maliepaard, C., Knights, D., Schulz, S., *et al.* (2011) Composition of human skin microbiota affects attractiveness to malaria mosquitoes. *Plos One*,**6**.
- Verhulst, N. O., Takken, W., Dicke, M., Schraa, G. & Smallegange, R. C. (2010) Chemical ecology of interactions between human skin microbiota and mosquitoes. *Fems Microbiology Ecology*,**74**, 1-9.
- Vézilier, J., Nicot, A., Gandon, S. & Rivero, A. (2012) *Plasmodium* infection decreases fecundity and increases survival of mosquitoes. *Proceedings of the Royal Society of London B: Biological Sciences*,**279**, 4033-4041.
- Wampfler, R., Mwingira, F., Javati, S., Robinson, L., Betuela, I., Siba, P., *et al.* (2013) Strategies for detection of *Plasmodium* species gametocytes. *PLoS One*,**8**, e76316.
- Webster, J. P. & McConkey, G. A. (2010) *Toxoplasma gondii*-altered host behaviour: clues as to mechanism of action. *Folia Parasitologica*,**57**, 95.
- WHO. (2015) *World Malaria Report 2015*. WHO, Geneva: Switzerland.
- Wipasa, J., Elliott, S., Xu, H. & Good, M. F. (2002) Immunity to asexual blood stage malaria and vaccine approaches. *Immunology and Cell Biology*,**80**, 401-414.
- Zoghi, S., Mehrizi, A. A., Raeisi, A., Haghdoost, A. A., Turki, H., Safari, R., *et al.* (2012) Survey for asymptomatic malaria cases in low transmission settings of Iran under elimination programme. *Malaria Journal*,**11**, 10.1186.
- Zollner, G. E., Ponsa, N., Garman, G. W., Poudel, S., Bell, J. A., Sattabongkot, J., *et al.* (2006) Population dynamics of sporogony for *Plasmodium vivax* parasites from western Thailand developing within three species of colonized *Anopheles* mosquitoes. *Malaria Journal* 5: 1475-2875

## Chapter 5

Gametocytaemia increases attractiveness of *Plasmodium falciparum*-infected Kenyan children to *Anopheles gambiae* mosquitoes

Annette O. Busula, Teun Bousema, Collins Mweresa, Daniel Masiga, James G. Logan, Robert W. Sauerwein, Niels O. Verhulst, Willem Takken and Jetske G. de Boer

Accepted (Journal of Infectious Diseases) 2017

## Abstract

Rodents and birds infected with malaria parasites are known to receive more bites from mosquitoes than non-infected counterparts, suggesting that *Plasmodia* may be able to manipulate vertebrate hosts to enhance their transmission. Using a dual-choice olfactometer, we investigated the attraction of *Anopheles gambiae sensu stricto* to 50 Kenyan children (aged 5-12 years) infected with asexual or gametocyte stages of *Plasmodium falciparum*, or non-infected controls. The tests were repeated after treatment of infected children with the anti-malarial drug artemisinin-lumefantrine to assess intrinsic attractiveness and changes in attractiveness following clearance of parasite populations. Microscopic gametocyte carriers attracted almost two times more mosquitoes than children that were parasite-free, harboured asexual stages only or had submicroscopic gametocyte densities. Attractiveness of gametocyte carriers but not of the other groups was significantly higher before than after antimalarial treatment and was associated with clearance of gametocytes below molecular detection thresholds in all but two participants. High levels of gametocytaemia were thus associated with high attractiveness of children compared to children without gametocytes or with low levels of gametocytaemia. Attractiveness of the children to *An. gambiae* was not influenced by gender or age of children. These findings may impact epidemiological studies and models of malaria transmission because differential attractiveness of human hosts could considerably influence patterns of mosquito exposure.

## Introduction

Numerous parasites alter the phenotype or behaviour of their hosts to increase their transmission success and thereby fitness (Dawkins, 2012). For example, *Trypanosoma*-infected tsetse flies (Van Den Abbeele *et al.*, 2010) and plague-infected fleas (Eisen & Gage, 2012) express higher host probing and/or biting rates than their non-infected counterparts. *Plasmodium* parasites also alter the phenotype of infected mosquitoes, e.g. by increased blood-meal size, frequency of feeding or enhanced responses to host odour (Koella *et al.*, 1998; Smallegange *et al.*, 2013).

Manipulation by parasites can also occur through the vertebrate host rather than directly in the vector. In case of malaria, it is expected that infected hosts become more attractive to vector mosquitoes than non-infected hosts, particularly when transmissible stages (gametocytes) are present. This phenomenon has indeed been shown in studies involving a range of *Plasmodium* and mosquito species (Lacroix *et al.*, 2005; Cornet *et al.*, 2013b; Batista *et al.*, 2014; De Moraes *et al.*, 2014). In Cornet *et al.* (2013), *Culex pipiens* preferred birds chronically infected with *P. Relictum* over non-infected birds or acutely infected birds (Cornet *et al.*, 2013b). Batista *et al.* (2014) found that humans infected with *P. vivax* gametocytes were significantly more attractive to *Anopheles darlingi* before antimalarial treatment than during or after medication (Batista *et al.*, 2014). High gametocyte levels during the chronic stage of infection with *P. chabaudii* also caused increased attractiveness of mice to *An. stephensi* compared to infection during either acute or post-chronic stage, or to healthy mice (De Moraes *et al.*, 2014). Several volatile compounds namely tridecane, 3-methyl butanoic acid, 2-methyl butanoic acid, hexanoic acid, and benzothiazole were suggested to play a significant role in mediating the host-seeking behaviour of *An. stephensi* to malaria-infected mice. De Moraes *et al.* (2014) thus showed that the skin odour profile of infected mice changed, supporting manipulation by *Plasmodium* parasites.

Lacroix *et al.* (2005) performed a mosquito-choice experiment with parasite-free children (by microscopy) and children naturally infected with *P. falciparum* asexual parasites or sexual stage parasites (gametocytes). All participants were non-febrile and asymptomatic. Their results showed that microscopic gametocyte carriers were significantly more attractive to the

malaria vector *An. gambiae sensu stricto* (hereafter *An. gambiae*) than asexual carriers or parasite-free children (Lacroix *et al.*, 2005). After antimalarial treatment with sulfadoxine-pyrimethamine, attractiveness of the children was tested again and formerly gametocytaemic children were found to be equally attractive as the other groups (Lacroix *et al.*, 2005). Although these results seem to offer evidence for manipulation by malaria parasites, it remains unclear whether the gametocytes specifically and not asexual parasites induce increased attractiveness to mosquitoes, and whether there is a density-dependent relationship between gametocytaemia and attractiveness.

Submicroscopic levels of gametocytes are common in the study area in western Kenya (Bousema *et al.*, 2004), and it is highly plausible that a significant number of the parasite-free or asexual carriers of *P. falciparum* could have harboured low levels of gametocytes. Similarly, there is increasing evidence for the widespread presence of submicroscopic infections in individuals who appear infection-free by microscopy (Okell *et al.*, 2012), which may have confounded the infection-free population in the original study by Lacroix *et al.* (2005).

In this study, we therefore further explored the hypothesis that malaria gametocytes manipulate host attractiveness to mosquitoes by investigating whether sub-clinical *P. falciparum* infection with different lifecycle stages affects host-seeking behaviour of malaria mosquitoes. We used sensitive stage-specific molecular methods to detect low levels of gametocytes or parasites (Schneider *et al.*, 2004). A dual-choice olfactometer in Mbita, Kenya was used to test the attractiveness of parasite-free children, carriers of gametocyte or asexual stages of *P. falciparum* to *An. gambiae* when compared against a standardized control odour. Infected children had acquired the infection naturally. Attractiveness of all children was tested again three weeks after antimalarial treatment with artemisinin-lumefantrine, which rapidly clears asexual parasites and also has a pronounced effect on post-treatment gametocyte prevalence and density (Gonçalves *et al.*, 2016; WWARN, 2016).

## **MATERIALS AND METHODS**

### **Study area**

The study was conducted between February and August 2015 at the Thomas Odhiambo Campus of the International Centre of Insect Physiology and Ecology (*icipe*), in western Kenya (00°25'S, 34°13'E). Study participants originated from Rusinga Island or Lambwe valley, located in Suba District, Homabay County. *Plasmodium falciparum* is the leading cause of morbidity in the study area and the vectors transmitting malaria are *An. funestus*, *An. gambiae* and *An. arabiensis* (Bayoh et al., 2010; Homan et al., 2016). Transmission of malaria occurs throughout the year, with peaks at the end of the rainy seasons, when parasite prevalence is around 30% (WHO, 2015). The majority of residents lives in mud-walled houses, roofed with corrugated iron sheets with one door and open eaves, and is engaged mainly in subsistence farming and fishing (Oria *et al.*, 2014).

### **Procedures for recruiting children**

Participants were recruited among asymptomatic school children aged 5-12 years at schools in Suba District. Children were asked to participate in the olfactometer assay directly on the day of malaria-screening when they were found with asexual stages or gametocytes of *P. falciparum* by microscopy. Parasite-free individuals were screened by PCR a week earlier because of the time it took to run PCRs and confirm the absence of *P. falciparum* parasites (see below). Parasite-free children were screened again for malaria by all diagnostic methods (see below) on the day they participated in olfactometer assays. Further inclusion criteria

for study participants were: willingness of their parents or guardians to sign the informed consent form, absence of malaria symptoms and an in-ear temperature below 37.5°C, no chronic diseases such as the human immunodeficiency virus (HIV) or tuberculosis (Roitberg *et al.*, 2003), not having been treated against malaria in the past two weeks, willingness to be treated against malaria in case of a positive diagnosis and willing to have an extra 50 µL of blood stored for further analysis) for all participants as described below. PCR and microscopy data were used for inclusion of children in the experiment, while 18S qPCR and gametocyte-specific nucleic acid sequence based amplification (NASBA) data became available at a later time-point and were used to further categorize participants into four groups: (1) parasite-free; (2) asexual stages only; (3) submicroscopic gametocytes; (4) microscopic gametocytes.

The same children were revisited for the same procedures three weeks after antimalarial treatment of infected children (further referred to as after antimalarial treatment, even though parasite-free children did not receive this treatment).

### **Diagnosis of malaria parasites**

#### *Microscopic determination of P. falciparum*

The ring finger of the participant was sterilised with an alcohol swab and the ball punctured using a sterile single-use monolet lancet (SD Bioline, Gyeonggi-do, Republic of Korea). Thick and thin smears were prepared and stained with 3 % Giemsa (Sigma-Aldrich, Darmstadt, Germany) for one h, according to WHO protocol (WHO, 2015). Thin smears were fixed with pure methanol (Scharlau, Barcelona, Spain) prior to staining. Smears were examined with a  $\times 100$  oil immersion (Sigma-Aldrich, Darmstadt, Germany) objective at  $1,000 \times$  magnification. Three independent experienced microscopists read the smears according to WHO protocol (WHO, 2015) and each was blinded to the other's reads. Slides were considered to be negative if parasites were not observed in 200 microscopic fields of the thick film. When thick films were positive, thin films were read for determination of *Plasmodium* species, and those with non-falciparum malaria were excluded from the study. Asexual stage and gametocyte density were determined by counting the number of asexual *P. falciparum* parasites per 200 white blood cells. Assuming a standard white blood cell count of  $8000/\mu\text{L}$  of blood this results in a detection limit of 40 parasites/ $\mu\text{L}$  or 40 gametocytes/ $\mu\text{L}$  (WHO, 2015). Presence of the asexual stage of *P. falciparum* was determined by at least two slide readers. Slides were considered gametocyte-positive when one or more gametocytes were observed by at least one slide reader.

#### *Plasmodium-specific diagnostic PCR assay*

Blood from the finger-prick was also blotted onto a Whatman no. 3 filter paper, which was dried overnight, transferred to a zip lock bag containing silica gel and stored at  $-20^{\circ}\text{C}$  until analysis. Each microfiber paper contained three separate dry blood spots (DBS) of about five mm diameter and of undefined volume. DNA was extracted from two discs (3 mm) per participant using a saponin/chelex method (Baidjoe *et al.*, 2013). Two discs, measuring three mm in diameter were punched from the centre of two dried blood spots of each participant

and transferred into a 1.5-mL sterile tube. Eight hundred  $\mu\text{L}$  of a 0.5% saponin (Sigma-Aldrich, Darmstadt, Germany) solution was added to each tube at room temperature. The tubes containing DBS discs were left to shake overnight for elution of antibodies. Thereafter, each tube was placed on ice, saponin was discarded and one mL of phosphate-buffered saline (PBS, pH 7.4) washing solution was added. The tubes were shaken further for one h before PBS was aspirated and discarded. One hundred and fifty  $\mu\text{L}$  of 6% Chelex (Bio-Rad Laboratories, USA), in DNase/RNase-free water (Sigma-Aldrich, Darmstadt, Germany) was then added to each tube. The tubes were sealed and incubated in a water bath three times for ten min at  $95^{\circ}\text{C}$  while shaking after every ten min to relieve pressure. After the last ten min incubation, the tubes were spun down for 2.5 min at maximum speed of 14,000 rpm to allow the Chelex to settle and bind positively to the charged oxidative elements. Seventy  $\mu\text{L}$  of the solutions containing DNA were pipetted into new tubes and the samples were stored at  $-70^{\circ}\text{C}$  until further analyses. Positive and negative controls were used to ensure that cross-contamination did not occur during DNA extraction.

Nested PCR targeting a fragment of the 18S rRNA genes (Snounou *et al.*, 1993) was performed in two steps and all the reactions were carried out in a total reaction volume of 25  $\mu\text{L}$ , with 5  $\mu\text{L}$  template DNA in N1, which amplified the 1200 base pair, fragment spanned by rPLU5 (5'-CCTGTTGTTGCCTTAAACTTC-3'), and rPLU6 (5'-TTAAAATTGTTGCAGTTAAAACG-3'). PCR mixture was prepared from buffer, dNTPs,  $\text{MgCl}_2$ , primers (Eurofins), Taq polymerase (PromegaTaq Kit, Germany) and sterile water. In the second PCR (N2), 2  $\mu\text{L}$  of amplified N1 product was used as a template for *P. falciparum*-specific fragment amplification using FAL1 (5'-TTAAACTGGTTTGGGAAAACCAAATATATT-3') and FAL2 (5'-ACACAATGAACTCAATCATGACTACCCGTC-3'). The N1 and N2 PCRs consisted of a series of 30 and 35 amplification cycles, respectively with three different temperature steps: denaturation ( $95^{\circ}\text{C}$ ), annealing ( $58^{\circ}\text{C}$ ) and elongation ( $72^{\circ}\text{C}$ ). A negative water control, and a positive control with an appropriate template (DNA of *P. falciparum*, NF54 cultured in Nijmegen, the Netherlands) (Baidjoe *et al.*, 2013), were always included in N1. N2 products were visualized on a 0.8% agarose gel by electrophoresis in 0.5X Tris-acetate-EDTA buffer (0.04 M Tris-acetate and 1 mM EDTA, pH 8.0). Every DNA extract was run in PCR twice. Sensitivity of



this PCR is reported to be approximately 1-10 parasites/dried blood spot of 30 uL volume (Hwang *et al.*, 2012), and using this method for inclusion of participants increased the likelihood of obtaining participants that were parasite-free by 18S qPCR. The gel image was captured on InGenius LHR gel documentation system (Syngene, Cambridge, U.K.) and scored visually for the presence or absence of PCR bands (size of the amplified product for *P. falciparum* is 205 bp).

#### *Molecular detection of total parasites and gametocytes*

Fifty µL of finger-prick blood collected from each individual during infection with malaria parasites and after antimalarial treatment was stored in 250 µL of RNAprotect® cell reagent (Qiagen, Hilden, Germany) at -70°C until shipment to Radboud University Medical Center (Nijmegen, The Netherlands) for molecular detection of *P. falciparum*. Total nucleic acid was extracted using a MagNAPure LC automatic extractor (Total Nucleic Acid Isolation Kit–High Performance; Roche Applied Science, Indianapolis, IN, USA). The density of all stages of *P. falciparum* was determined by quantitative PCR of a fragment of the 18S rRNA genes (Hermsen *et al.*, 2001). The 18S qPCR was run in duplicate and the average value of the two runs was used in the analyses. Mature gametocytes were detected by NASBA on the *Pfs25* mRNA gene (Schneider *et al.*, 2004), with a slight modification in the potassium chloride concentration used: 60 instead of 80 mM as described in Gonçalves *et al.* (2016), using the NucliSens Basic Kit for amplification, in a total reaction volume of 10 µL per reaction. Gametocyte density was calculated based on a standard gametocyte stage V dilution series, using the time-point of amplification at which the fluorescence detecting target amplicons exceeded the mean fluorescence of three negative controls + 20 SD. The detection limit of qPCR and QT-NASBA is approximately 0.01-0.02 parasites per µL of blood (Ouédraogo *et al.*, 2016). Samples with an estimated parasite density of <0.02 parasites/µL were considered parasite-negative

#### **Experimental procedures for the olfactometer assay**

##### *Preparation of a standardized control odour*

In order to prepare a standardized control odour, worn nylon socks were collected from ten adult men residing in Mbita, Kenya, who tested negative for malaria parasites by PCR (as

described above). The men were asked to wear nylon socks (20 denier, Hema, The Netherlands) for 24 h while they refrained from using alcohol (Lefevre *et al.*, 2010), spicy food and taking a shower with soap (Verhulst *et al.*, 2011b). Worn socks were collected and stored in pre-cleaned glass jars (Fisher Scientific, Loughborough, U.K) at -20°C until use. Further, a strip from one sock of each of the ten parasite-free men was combined into a set of ten strips. In this way, ten identical sets of strips were obtained to be used as control odours in the olfactometer experiment. The sets of strips were stored in cleaned glass jars at -20°C until and between use.

#### *Preparation of CO<sub>2</sub>*

Carbon dioxide was used to activate mosquitoes in the choice chamber of the olfactometer. Carbon dioxide was prepared daily by mixing 17.5 g yeast (Angel ® Company, China), 250 g sugar (Mumias Sugar Co Ltd, Kenya), and 2 L water in 5 L plastic containers (Saitoh *et al.*, 2004; Smallegange *et al.*, 2010).

#### *Mosquitoes*

Experiments were conducted with a laboratory-reared Mbita strain colony of *An. gambiae s.s.* Mosquitoes were reared under ambient atmospheric conditions in screen houses (Mweresa *et al.*, 2014). Adult mosquitoes were blood-fed on a human arm three times a week, and fed on 6% glucose solution provided through wicks of adsorbent tissue paper. Eggs were laid on moist filter paper and dispensed into plastic rearing trays measuring 35 cm × 25 cm × 5 cm, containing filtered water from Lake Victoria. All larval instars were fed on cat food (Purina Go, U.K.), three times per day. Pupae were collected daily, placed in clean cups half filled with filtered lake water and transferred into mesh-covered cages (30 × 30 × 30 cm) prior to adult emergence. One-hundred female *An. gambiae* aged 3-7 d that had no prior access to a blood-meal were randomly aspirated from the colony cages and transferred to small holding cups, eight h before being used in the olfactometer assay. Mosquitoes were provided with water on cotton wool placed on top of mosquito holding cups until use.

### *Olfactometer experiment*

A maximum of four participants was recruited per evening (18:30-21:30hr), aiming for one or more with gametocyte stages of *P. falciparum*, one with asexual stages (both determined by microscopy), and one parasite-free child (confirmed by nested PCR). Children were transported to *icipe* at Mbita point for relative comparisons with a standardized human odour (control) during the 30 min. experiment, in the olfactometer. Parents or guardians were invited to accompany their children to *icipe*.

Before the olfactometer assay was conducted, children were dressed in clean short-sleeved cotton T-shirts and shorts that were washed with an odourless soap 'menengai' (Kapa Oil Refineries limited, Kenya) prior to use. Participants' gender and age were noted, while the weight, body temperature and haemoglobin level (Hb) were measured using a weighing scale, in-ear thermometer, and the HemoCue<sup>®</sup> Hb 301 system (Angelholm, Sweden), respectively. Additionally, 50 µL of blood was obtained for molecular diagnostics of *P. falciparum* (see above).

Two dual-choice aluminium built olfactometers, modified from Olanga *et al.* (2010) were used in this experiment. Each olfactometer opens directly to two trap chambers, which were connected to two tents that can either sit a person or hold another odour source (figure 1). Before the study, the four olfactometer tents were cleaned with tap water and fitted with new inner (cotton) and outer (black PVC) covers. They were placed inside a 7×11 m screen house (Verhulst *et al.*, 2011a) and cleaned again when not in use for more than one week. One recruited child was positioned in one tent and the standard human odour (nylon strips) in the other tent.

Both odours were connected to the choice chamber of the olfactometer, which was approximately one metre away from the odours. Same sets of sock strips were used throughout one evening and rotated between evenings. Positions of children or control odour were alternated between the two tents of one olfactometer in subsequent runs to minimize positional bias.

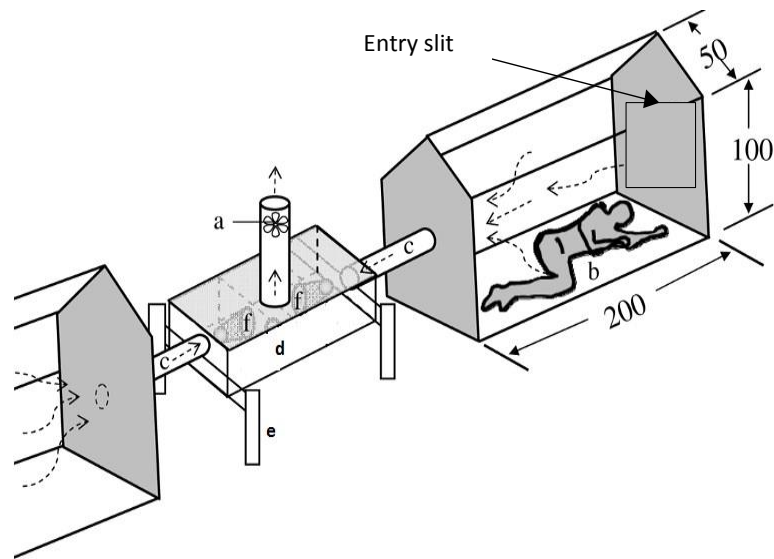

Figure 1. The dual choice olfactometer used to test the response of *An. gambiae* mosquitoes to either the control odour of worn nylon strips placed in one tent and either a parasite-free child, asexual or gametocyte carrier of *P. falciparum* in the other tent. The fan (a) drew air from the two tents (b) via aluminium tubes to the outside environment. Wooden stands (e) supported the olfactometer. Mosquitoes were released in the central choice chamber (d) from below, and they were caught in the exit traps (c) through the openings connected to the two tents. CO<sub>2</sub> was released into the choice chamber from the bottom, near the mosquito release point, to activate the mosquitoes. Figure not drawn to scale and the measurements are in centimetres. Adapted from Olanga *et al.* (2010).

Selected female *An. gambiae* mosquitoes were released into the choice chamber of the olfactometer and their preference for odour from either tent was recorded after thirty min. Mosquitoes that did not make a choice were removed from the choice chamber thereafter. Children were not exposed to mosquito bites because the olfactometer assay was 100% exposure free (Mukabana *et al.*, 2004; Olanga *et al.*, 2010). On the same evening, after the experiment, all malaria positive participants were treated by administration of weight-based dosing of artemisinin-lumefantrine, 20 mg artemisinin/120 mg lumefantrine per tablet (Coartem-D™; Novartis, Basel, Switzerland) according to WHO recommendations (WHO, 2015). The experimental clothes were retained for cleaning and use in subsequent experiments before taking the children back home. Three weeks after antimalarial treatment, the same children were tested for attractiveness using the two pairs of olfactometers as in the first sampling moment. The same individuals were placed in the same tent.

### **Ethical considerations**

The goal, rationale and procedures of the study were explicitly discussed with parents, guardians and children. Participants were recruited in the study after obtaining signed consent. The study protocol (NON SSC 389) was approved by the Scientific and Ethical Review Committee of the Kenya Medical Research Institute (KEMRI) (KEMRI/RES/7/3/1).

### **Statistical analysis**

Three children withdrew from the experiment after antimalarial treatment and their data were excluded from analysis. Three children that were parasite-free by nested PCR but for which no 18S qPCR and NASBA data were available, were also excluded from the analyses. The remaining 50 children were categorized into four groups based on malaria diagnosis by microscopy, 18S qPCR and gametocyte-specific NASBA (figure 2A): (1) Parasite-free children were negative for the presence of malaria parasites by 18S qPCR; (2) Children with asexual stages included those that were positive for asexual stages by microscopy and/or positive by 18S qPCR but negative for gametocyte-specific NASBA; (3) Children that were positive by gametocyte-specific NASBA but had no microscopic gametocytes were categorized as submicroscopic gametocytes; (4) Children with gametocytes by microscopy. This approach was used to retain maximum sample size because molecular data (18S qPCR and/or NASBA) were missing for 22 out of 106 samples.

Attractiveness was assessed as mosquito response or as mosquito choice. Mosquito response was defined as the total number of mosquitoes trapped per child over the number of mosquitoes released (100). A generalized linear mixed model (GLMM), assuming a binomial distribution with logit link function, was used to investigate the main effects of parasitological status (parasite-free, asexuals, submicroscopic gametocytes, gametocytes) and moment of sampling (before versus after antimalarial treatment) and their interaction on mosquito response as fixed effect terms. Mosquito response was defined as the total number of mosquitoes trapped per child (used as the response variable), and the number of mosquitoes released (100) was used as the binomial total. Participant was used as a random effect term in the model. The effects of date, olfactometer tents, time of experiment, set of sock strips, age of children, gender, Hb level and body temperature were fitted in the model as fixed effect terms but dropped when they had no significant effect ( $P > 0.05$ ). After the

non-significant terms were dropped from the model, the estimated mean numbers of mosquitoes for each category of parasitological status and sampling moment were calculated. Differences between parasitological status within sampling moment and differences between sampling moment within category of parasitological status were tested by pairwise comparisons using least square differences (Wheeler & Tiefelsdorf, 2005). Effects were considered significant at  $P < 0.05$ .

We also examined mosquito choice, defined as the proportion of mosquitoes attracted to children relative to the control odour. The GLMM procedure was the same as described above for mosquito response but in this case the sum of mosquitoes caught on the child and on the set of sock strips was used as the binomial total. The mosquitoes that were not trapped are therefore not taken into account in this analysis.

Levels of parasitaemia and gametocytaemia as measured by microscopy and molecular methods (18S qPCR), as well as of other covariates measured on participants (age, weight, body temperature and Hb levels) were compared between parasitological status groups (parasite-free, asexuals, submicroscopic gametocytes and gametocytes) with One-way ANOVAs for data of each sampling moment separately (*i.e.* before or after antimalarial treatment). ANOVAs accounted for unbalanced designs and were followed by pairwise comparison between categories within sampling moment using Bonferroni tests. All analyses were run in GenStat 18<sup>th</sup> edition (VSN International, U.K).

## **Results**

### *Study population*

The study tested the attractiveness of children in a dual-choice olfactometer at two time periods: before antimalarial treatment and three weeks after treatment of the *Plasmodium*-infected participants with artemisinin-lumefantrine. Among the 53 recruited children, 12 were parasite-free participants (*i.e.* negative for the presence of *P. falciparum* by 18S qPCR) (N, n=12), 9 were asexual *P. falciparum* carriers (positive for asexual stages by microscopy and/or by 18S qPCR but without gametocytes by QT-NASBA) (A, n=9), 10 were categorized as submicroscopic gametocyte carriers (positive for gametocyte-specific QT-NASBA but

negative for gametocytes by microscopy) (SG, n= 10), and 19 were microscopic *P. falciparum* gametocyte carriers, (MG, n=19); three children were excluded from the analyses because they were slide-negative and 18S qPCR and NASBA data were missing (figure 2A and Table 1).

After antimalarial treatment, no parasites were observed in the four groups of children by microscopy. Parasite and gametocyte prevalence measured by molecular methods also dropped considerably following antimalarial treatment (figure 2B and Table 1), although parasites were still detectable in both groups of former gametocyte carriers (3 out of 6 of the former submicroscopic gametocyte carriers, and 10 out of 15 of the former gametocyte carriers). Only three children (one SG, two MG) out of 40 children still had submicroscopic gametocytes by NASBA after antimalarial treatment (figure 2B). Median age of participants was 9 years and was statistically similar among the four categories (ANOVA,  $P = 0.185$ ). Before antimalarial treatment, tympanic temperature was significantly influenced by parasitological status (Table 1, ANOVA,  $P = 0.038$ ). Participants of the asexual group had a significantly higher tympanic temperature than those of the submicroscopic gametocyte group (Bonferroni pairwise comparisons,  $P < 0.008$ ). Haemoglobin levels also varied with parasitological status before antimalarial treatment but the effect was not significant (Table 1, ANOVA,  $P = 0.079$ ).

(A)

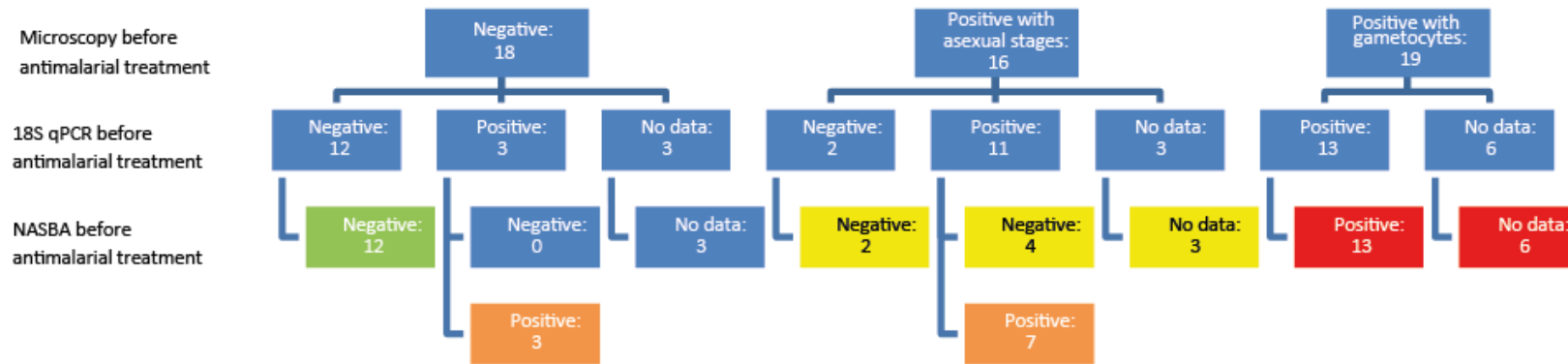

(B)

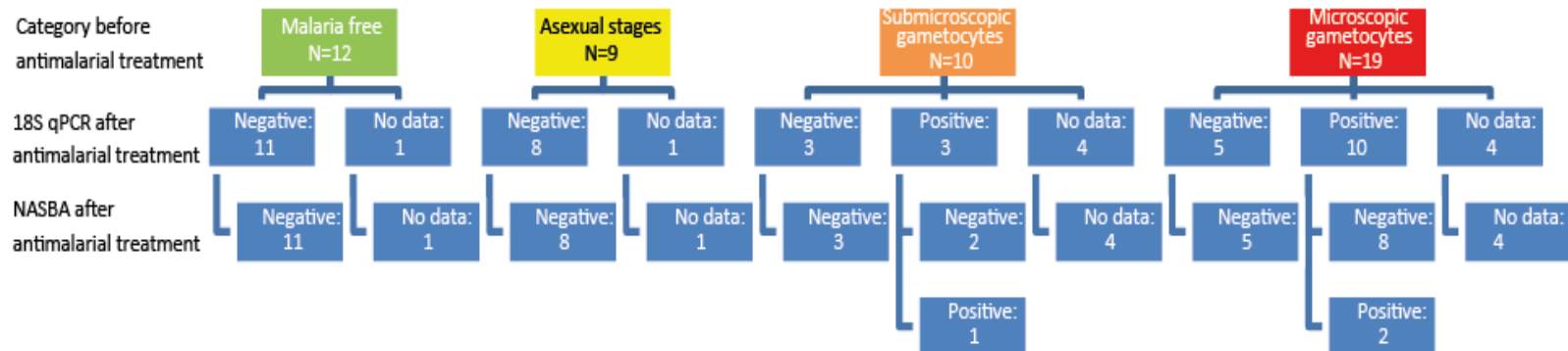

Figure 2. Flow diagram of diagnostic methods used to categorize participants into four parasitological status groups. Panel A shows the number of children that were found to be negative or positive according to microscopy, 18S qPCR and gametocyte specific NASBA before antimalarial treatment. The four categories used in analyses are indicated with green (parasite-free), yellow (asexual stages), orange (submicroscopic gametocytes) and red (microscopic gametocytes). Panel B shows the number of children that were found to be negative or positive *after* antimalarial treatment according to 18S qPCR and gametocyte specific NASBA of each of the four categories before antimalarial treatment.



Table 1. Overview of study population categorized by parasitological status before antimalarial treatment according to microscopy, 18S qPCR and gametocyte specific NASBA. The same categorization was used after antimalarial treatment, *i.e.* parasite-free, asexual, submicroscopic gametocytes and microscopic gametocytes refer to those children that were parasite-free, asexual, submicroscopic gametocyte or microscopic gametocyte carriers before antimalarial treatment respectively. All values indicate means  $\pm$  standard errors, with the number of replicates in brackets. Molecular quantification of total *Plasmodium* parasites (by 18S qPCR) as well as asexual and gametocyte densities as measured by microscopy are given. Different letters in the superscripts indicate significant differences in the means between parasitological status groups within round of testing (One-Way ANOVAs, Bonferroni tests,  $P < 0.008$ ). Means of other parameters measured on children and evaluated as covariates in the statistical analyses of attractiveness are also given.

Parameter	Before antimalarial treatment					After antimalarial treatment				
	N	Malaria-free	Asexual	Submicroscopic gametocytes	Microscopic gametocytes	N	Malaria-free	Asexual	Submicroscopic gametocytes	Microscopic gametocytes
<b>Male/ Female</b>	50	7M/5F	6M/3F	4M/6F	11M/8F					
<b>Total parasites by 18S qPCR</b>	41	0 <sup>a</sup> (12)	10628±9968 <sup>a</sup> (6)	101203±74303 <sup>a</sup> (10)	156180±102432 <sup>a</sup> (13)	40	0 <sup>a</sup> (11)	0 <sup>a</sup> (8)	23547±23529 <sup>a</sup> (6)	29±20 <sup>a</sup> (15)
<b>Asexuals by microscopy (par/μL)</b>	49	0 <sup>a</sup> (12)	1102±404 <sup>a</sup> (9)	1360±721 <sup>a</sup> (10)	342.2±215.9 <sup>a</sup> (18)	50	0 (12)	0 (9)	0 (10)	0 (19)
<b>Gametocytes by microscopy</b>	50	0 <sup>a</sup> (12)	0 <sup>ab</sup> (9)	0 <sup>ab</sup> (10)	162±57 <sup>b</sup> (19)	50	0 (12)	0 (9)	0 (10)	0 (19)
<b>Age (years)</b>	50	7.8±0.6 <sup>a</sup> (12)	8.9±0.7 <sup>a</sup> (9)	9.7±.6 <sup>a</sup> (10)	9.1±0.5 <sup>a</sup> (19)	50	7.8±0.6 <sup>a</sup> (12)	8.9±0.7 <sup>a</sup> (9)	9.7±.6 <sup>a</sup> (10)	9.1±0.5 <sup>a</sup> (19)
<b>Body weight (kg)<sup>*</sup></b>	50	24.1±1.7 <sup>a</sup> (12)	28.3±1.8 <sup>a</sup> (9)	29.3±3.1 <sup>a</sup> (10)	28.6±1.9 <sup>a</sup> (19)	50	23.4±1.7 <sup>a</sup> (12)	28.1±1.8 <sup>a</sup> (9)	29.3±3.1 <sup>a</sup> (10)	28.5±1.9 <sup>a</sup> (19)
<b>Hb (mmol/L)</b>	46 <sup>**</sup>	7.80±0.37 <sup>a</sup> (11)	7.69±0.33 <sup>a</sup> (9)	7.04±0.39 <sup>a</sup> (10)	6.84±0.20 <sup>a</sup> (16)	50	7.64±0.25 <sup>a</sup> (12)	7.49±0.26 <sup>a</sup> (9)	7.15±0.44 <sup>a</sup> (10)	7.12±0.14 <sup>a</sup> (19)
<b>Axillary temperature (°C)</b>	50	36.1±0.1 <sup>ab</sup> (12)	36.5±0.3 <sup>b</sup> (9)	35.6±0.2 <sup>a</sup> (10)	36.1±0.1 <sup>ab</sup> (19)	50	36.3±0.2 <sup>a</sup> (12)	36.1±0.3 <sup>a</sup> (9)	36.1±0.2 <sup>a</sup> (10)	36.1±0.1 <sup>a</sup> (19)

\*Body weight was not used in the statistical analyses of attractiveness because of its correlation with age.

\*\*Four outliers from the Hb data were excluded from Hb analysis.

### *Effect of parasitological status on attractiveness*

Standardized human odour was used as a control versus each child and attractiveness determined as mosquito response (*i.e.* number of mosquitoes attracted to the child), and mosquito choice (*i.e.* proportion of mosquitoes attracted to the child as a fraction of the total number of mosquitoes trapped). We first assessed the effect of parasitological status (parasite-free, asexuals, submicroscopic or microscopic gametocytes) on mosquito *response* to children. Before antimalarial treatment, children of the four parasitological status groups attracted on average 22 to 54 mosquitoes, with the gametocyte carriers attracting the largest number (figure 3A). After antimalarial treatment of the infected children, children of the four groups attracted on average 24 to 29 mosquitoes of the 100 released. Parasitological status and moment of testing, *i.e.* before or after antimalarial treatment, and the interaction between parasitological status and sampling moment significantly affected mosquito response to children (Supplementary figure S.1, GLMM,  $P_{\text{status}} < 0.001$ ,  $P_{\text{sampling moment}} < 0.001$ ,  $P_{\text{status*sampling moment}} < 0.001$ ). Of the covariates associated with participants (Table 1), Hb had a significant effect on mosquito response and was included in the final model (GLMM,  $P_{\text{Hb}} = 0.005$ ). There was no significant effect on mosquito response of the interaction between Hb and parasitological status, or Hb and moment of testing (GLMM, both  $P > 0.05$ ). Of the covariates associated with the set-up, day of experiment significantly affected mosquito response (GLMM,  $P_{\text{date}} < 0.001$ ).

Before antimalarial treatment, children who harboured microscopic gametocytes attracted almost twice as many mosquitoes than children in the other three groups (figure 3A and supplementary figure S.1 and Table S.1, GLMM, pairwise comparisons,  $P < 0.05$ ). The presence of submicroscopic gametocytes or asexual stages of *P. falciparum* did not increase attractiveness of children compared to parasite-free children before antimalarial treatment (figure 3A and supplementary figure S.1 and Table S.1, GLMM, pairwise comparisons,  $P > 0.05$ ).

After antimalarial treatment, mosquito responses to the four groups of children, former gametocyte carriers, former submicroscopic gametocyte carriers, asexual carriers and parasite-free children did not differ significantly (figure 3A and supplementary figure S.1 and

Table S.1, GLMM, pairwise comparisons,  $P > 0.05$ ). Clearance of microscopic gametocytes following antimalarial treatment (Table 1) significantly reduced mosquito response (about two times) compared to before treatment (figure 3A and supplementary figure S.1 and Table S.1, GLMM, pairwise comparisons, 0.05), and indeed only two of the 19 children in this group still harboured submicroscopic gametocytes.

Results of the analyses of mosquito *choice* between children and the standard control odour were similar to those of mosquito response (figure 3B, GLMM,  $P_{\text{status}} = 0.004$ ,  $P_{\text{sampling moment}} = 0.052$ ,  $P_{\text{status} * \text{sampling moment}} < 0.001$ ,  $P_{\text{date}} = 0.007$ ). Before antimalarial treatment, children of the four parasitological status groups attracted on average between 69-84% of trapped mosquitoes, with the gametocyte carriers attracting the largest proportion (figure 3B and supplementary figure S.2 and Table S.2, GLMM, pairwise comparisons,  $P < 0.05$ ). After antimalarial treatment, children of the four groups attracted statistically similar proportions of trapped mosquitoes (71-75%, figure 3B, GLMM, pairwise comparisons,  $P > 0.05$ ).

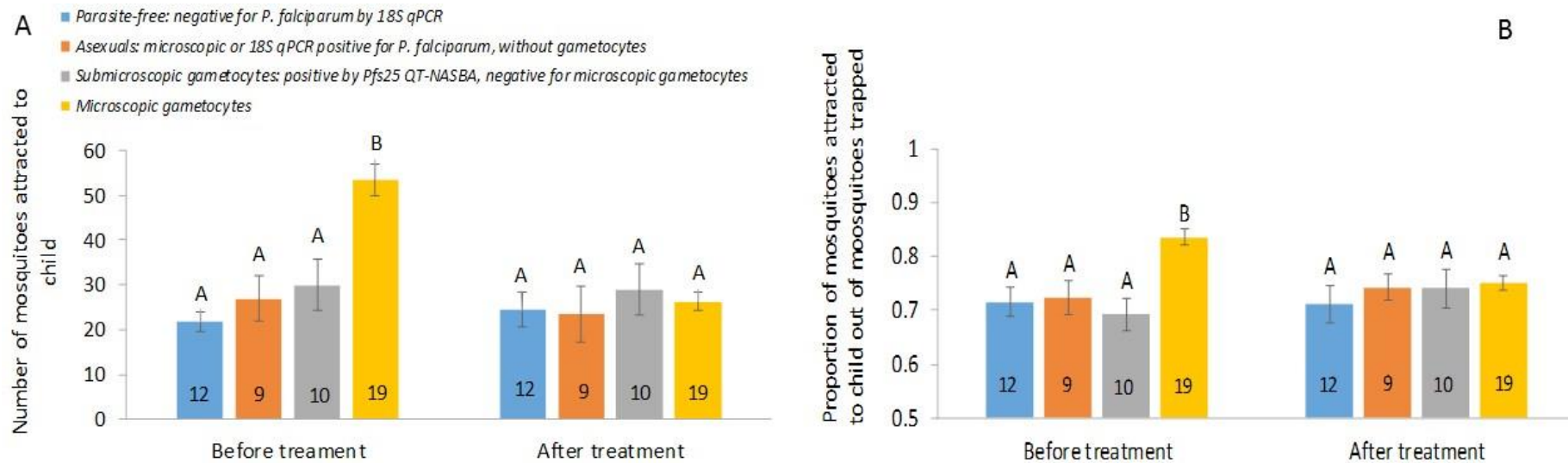

Figure 3. Results from the olfactometer experiment in which groups of 100 mosquitoes were offered a choice between either a parasite-free child, a child with asexual stages, submicroscopic, or microscopic levels of gametocytes of *P. falciparum* versus a standardized control odour (worn socks). Experiments were done twice for every child, before and after treatment of infected children with the antimalarial drug, artemisinin-lumefantrine. Panel A shows the average number of mosquitoes attracted to children (mosquito response). Panel B shows the average choice of mosquitoes for children as a proportion of the total number of mosquitoes caught in both traps (child and sock). Error bars indicate standard errors of the mean. Numbers in bars indicate the number of study participants in each parasitological status group. Different letters above bars indicate significant differences in attractiveness of the children to malaria mosquitoes (GLMM, pairwise comparisons,  $P < 0.05$ , see supplementary material for predicted means from the GLMM and standard errors of the differences).

## Discussion

Our results showed that a significantly higher proportion of mosquitoes was attracted to children than to the standard control odour, before and after antimalarial treatment. The presence of asexual parasites did not affect attractiveness when gametocytes were not present, or when they were present at low levels. In contrast, microscopic gametocyte carriers attracted almost twice as many *An. gambiae* mosquitoes than children without microscopic gametocytes. After antimalarial treatment, children of the four groups became equally attractive to mosquitoes. Comparisons within each group of children between the before and after antimalarial treatment moments showed higher attractiveness of the microscopic gametocyte carriers before than after antimalarial treatment, when gametocyte levels dropped below the microscopic threshold. The attractiveness of the other groups of children did not differ significantly before or after treatment. Together with Lacroix *et al.* (2005), we demonstrate that the presence of microscopic levels of *P. falciparum* gametocytes significantly increases attractiveness of children to mosquitoes. Importantly, we utilized sensitive molecular methods to confirm parasite-free participants and to identify the presence of gametocytes below the microscopic detection threshold. Interestingly, the presence of submicroscopic gametocytes did not contribute significantly to attractiveness. Additionally, we used these molecular methods to detect low levels of parasites or gametocytes during the follow-up after antimalarial treatment, confirming that children formerly infected with microscopic gametocytes attracted equal numbers of mosquito vectors as the other groups of children. This demonstrates that the presence of parasites played a role in attractiveness of children, and it was stage specific (gametocytes) as well as density-dependent. Our analyses generally show that the malaria manipulation effect was independent of gender, age, body temperature or Hb levels, although Hb significantly affected mosquito attraction, with lower Hb levels associated with higher attraction. *In vitro* feeding on blood with low haemoglobin levels does not affect survival of *An. gambiae* (Emami *et al.*, 2013), and may accelerate blood intake, as it does in *Aedes aegypti* (Shieh & Rossignol, 1992). It should be noted, though, that the number of participants in our study is small for such detailed analyses. Similarly, efforts to quantify a density-dependent effect of gametocytes on host attractiveness, or determine the minimum gametocyte density to manipulate mosquito choice, will require a larger sample that may be purposefully selected to include a range of gametocyte densities. The combined

findings support strongly our hypothesis that *Plasmodium* gametocytes, and not asexual stages, mediate the attractiveness of mammalian hosts to mosquitoes.

Results from the current and Lacroix *et al.* (2005) study suggest that infectious humans are more attractive and hence likely receive more mosquito-bites. Importantly, Churcher *et al.* (2013) found a relationship between gametocyte densities and mosquito infectivity such that higher gametocyte densities, on average, result in higher mosquito infection rates.

They reported no mosquito-infections from blood without gametocytes, infection rates of 1-4% at low gametocyte densities, and successful infection of 20% of mosquitoes at densities of more than 500 gametocytes/ $\mu$ L of blood. Our finding that gametocyte density is positively correlated with the degree of mosquito attraction is therefore interesting, as it underlines once more that parasites signal their presence at a stage when there is the greatest chance of successfully infecting their vectors. Humans harbouring high levels of gametocytes could thus contribute considerably more to malaria transmission than is currently assumed in epidemiological models of malaria transmission. Current epidemiological models do not take into account heterogeneous biting related to gametocyte-mediated attractiveness and disproportionate infection rates resulting from different levels of gametocytaemia (Smith *et al.*, 2004; Smith *et al.*, 2014). Should further investigations reveal that gametocyte-infected people are indeed bitten more under field conditions, it will be important to consider these elements in epidemiological models of malaria transmission because these models form an important basis of predicting disease outbreaks and planning for interventions.

Evidence is accumulating that manipulation of malaria-vectors by parasites can indeed occur indirectly through the vertebrate host (Cornet *et al.*, 2013b, 2013a; Batista *et al.*, 2014). The mechanisms underlying induction of increased attraction by gametocytes of *P. falciparum* are under investigation. In line with our study, De Moraes *et al.* (2014) demonstrated that high levels of *P. chabaudi* gametocytes were responsible for increased attractiveness in chronically infected mice. These researchers further identified a number of volatiles associated with malaria-infection and they suggested that the skin odour profile of infected mice changed due to manipulation by *Plasmodium* parasites. They identified elevated levels

of volatiles of bacterial origin in malaria-infected mice, and these were shown to increase attractiveness to *An. stephensi*. Our results suggest that malaria parasites can also change the VOCs of gametocyte carriers, making them more attractive to mosquitoes than asexual carriers or non-infected individuals. This may occur through alteration of the skin bacteria, which mediate odour production (Verhulst *et al.*, 2010, and Chapters 3 and 4). Interestingly, several volatile compounds of known skin bacterial origin were elevated in adult humans with early stage non-gametocyaemic *P. falciparum* infections (de Boer *et al.*, submitted).

Alternatively, host odour manipulation by *Plasmodium* may occur through direct emission of cues from malaria parasites. Kelly *et al.* (2015) showed that *P. falciparum* cultures produce terpenes, but it is not yet known whether these compounds are emitted through breath or skin of infected hosts. Berna *et al.* (2015) identified a group of thioethers in human breath samples, which may be used as volatile biomarkers of malaria infection.

Little is currently known about the importance of breath in host-searching of malaria vectors, but it is possible that breath contributes to relative attractiveness of people (Mukabana *et al.*, 2004). It is presently unknown whether terpenes and thioethers play a role in host-searching of malaria vectors. In our study, both breath and body odour were available as olfactory cues to host-searching mosquitoes. To start unravelling the mechanisms of malaria manipulation of vertebrate hosts, it should be investigated whether breath, body odours or both were involved in attractiveness of naturally infected children, such as those recruited in the current study.

In conclusion, the current study supports the hypothesis that children harbouring the transmissible (gametocytes) stage of *P. falciparum* are two times more attractive to malaria mosquitoes than asexual carriers or non-infected people, but high levels of gametocyaemia are necessary to result in increased attractiveness to malaria vectors. Additionally, the effect of *Plasmodium* manipulation was not influenced by covariates associated with children, supporting the role of gametocytes in attractiveness of the individuals. Further, volatile analyses of volatiles from parasite-free, asexual- and gametocyte carriers may result in identification of compounds that enable malaria mosquitoes to differentiate between



gametocyte-infected and non-infected persons. The attractive compounds, especially unique compounds from gametocyte carriers, may contribute to the development of new odour blends or they may be used in improvement of existing synthetic odour blends (Verhulst *et al.*, 2011b; Homan *et al.*, 2016). Such gametocyte-based odour blends are expected to be more effective in trapping malaria vectors resulting in reductions in mosquito vector population, hence malaria transmission.

### **Acknowledgements**

David Alila and Elisha Kobudho are appreciated for providing mosquitoes in the olfactometer experiments. Joseph Ogacho is appreciated for field assistance. Geoffrey O. Olweru is thanked for the technical support, while two additional slide re-readers, Paul O. Osodo and Sally Mongoi are appreciated. Our gratitude goes to the study participants, their parents/guardians and the minister for education, Mbita District, for their cooperation during the study. Saskia Burgers is thanked for advice on the experimental design and statistical analyses. This work was supported by a ZonMW TOP Grant (no. 91211038 to Willem Takken). TB is supported VIDI fellowship from the Netherlands Organization for Scientific Research (NWO, no. 016.158.306).

### **References**

- Baidjoe, A., Stone, W., Ploemen, I., Shagari, S., Grignard, L., Osoti, V., *et al.* (2013) Combined DNA extraction and antibody elution from filter papers for the assessment of malaria transmission intensity in epidemiological studies. *Malaria Journal*, **12**, 1.
- Batista, E. P. A., Costa, E. F. M. & Silva, A. A. (2014) *Anopheles darlingi* (Diptera: Culicidae) displays increased attractiveness to infected individuals with *Plasmodium vivax* gametocytes. *Parasites & Vectors*, **7**.
- Bayoh, M. N., Mathias, D. K., Odiere, M. R., Mutuku, F. M., Kamau, L., Gimnig, J. E., *et al.* (2010) *Anopheles gambiae*: historical population decline associated with regional distribution of insecticide-treated bed nets in western Nyanza Province, Kenya. *Malaria Journal*, **9**.

- Berna, A. Z., McCarthy, J. S., Wang, R. X., Saliba, K. J., Bravo, F. G., Cassells, J., *et al.* (2015) Analysis of breath specimens for biomarkers of *Plasmodium falciparum* infection. *Journal of Infectious Diseases*, **212**, 1120-1128.
- Bousema, J. T., Gouagna, L. C., Drakeley, C. J., Meutstege, A. M., Okech, B. A., Akim, I. N., *et al.* (2004) *Plasmodium falciparum* gametocyte carriage in asymptomatic children in western Kenya. *Malaria Journal*, **3**, 1-6.
- Churcher, T. S., Bousema, T., Walker, M., Drakeley, C., Schneider, P., Ouedraogo, A. L., *et al.* (2013) Predicting mosquito infection from *Plasmodium falciparum* gametocyte density and estimating the reservoir of infection. *Elife*, **2**.
- Cornet, S., Nicot, A., Rivero, A. & Gandon, S. (2013a) Both infected and uninfected mosquitoes are attracted toward malaria infected birds. *Malaria Journal*, **12**.
- Cornet, S., Nicot, A., Rivero, A. & Gandon, S. (2013b) Malaria infection increases bird attractiveness to uninfected mosquitoes. *Ecology Letters*, **16**, 323-329.
- Dawkins, R. (2012) *Host manipulation by parasites*. Oxford University Press.
- de Boer, J. G., Robinson, A., Powers, S. J., Burgers, S. L. G. E., Caulfield, J. C., Birkett, M. A., *et al.* (submitted). Odours of *Plasmodium falciparum*-infected participants influence mosquito-host interactions *Scientific Reports*.
- De Moraes, C. M., Stanczyk, N. M., Betz, H. S., Pulido, H., Sim, D. G., Read, A. F., *et al.* (2014) Malaria-induced changes in host odors enhance mosquito attraction. *Proceedings of the National Academy of Sciences of the United States of America*, **111**, 11079-11084.
- Eisen, R. J. & Gage, K. L. (2012) Transmission of flea-borne zoonotic agents. *Annual Review of Entomology*, **57**, 61-82.
- Emami, S. N., Ranford-Cartwright, L. C. & Ferguson, H. M. (2013) The impact of low erythrocyte density in human blood on the fitness and energetic reserves of the African malaria vector *Anopheles gambiae*. *Malaria Journal*, **12**.
- Gonçalves, B. P., Tiono, A. B., Ouédraogo, A., Guelbéogo, W. M., Bradley, J., Nebie, I., *et al.* (2016) Single low dose primaquine to reduce gametocyte carriage and *Plasmodium falciparum* transmission after artemether-lumefantrine in children with asymptomatic infection: a randomised, double-blind, placebo-controlled trial. *BMC Medicine*, **14**, 1-11.

- Hermesen, C. C., Telgt, D. S. C., Linders, E. H. P., van de Locht, L., Eling, W. M. C., Mensink, E., *et al.* (2001) Detection of *Plasmodium falciparum* malaria parasites in vivo by real-time quantitative PCR. *Molecular and Biochemical Parasitology*,**118**, 247-251.
- Homan, T., Hiscox, A., Mweresa, C. K., Masiga, D., Mukabana, W. R., Oria, P., *et al.* (2016) The effect of mass mosquito trapping on malaria transmission and disease burden (SolarMal): a stepped-wedge cluster-randomised trial. *Lancet*,**388**, 1193-1201.
- Hwang, J., Jaroensuk, J., Leimanis, M. L., Russell, B., McGready, R., Day, N., *et al.* (2012) Long-term storage limits PCR-based analyses of malaria parasites in archival dried blood spots. *Malaria Journal*,**11**.
- Kelly, M., Su, C. Y., Schaber, C., Crowley, J. R., Hsu, F. F., Carlson, J. R., *et al.* (2015) Malaria parasites produce volatile mosquito attractants. *Mbio*,**6**.
- Koella, J. C., Sørensen, F. L. & Anderson, R. (1998) The malaria parasite, *Plasmodium falciparum*, increases the frequency of multiple feeding of its mosquito vector, *Anopheles gambiae*. *Proceedings of the Royal Society of London B: Biological Sciences*,**265**, 763-768.
- Lacroix, R., Mukabana, W. R., Gouagna, L. C. & Koella, J. C. (2005) Malaria infection increases attractiveness of humans to mosquitoes. *Plos Biology*,**3**, 1590-1593.
- Lefevre, T., Gouagna, L. C., Dabire, K. R., Elguero, E., Fontenille, D., Renaud, F., *et al.* (2010) Beer Consumption Increases Human Attractiveness to Malaria Mosquitoes. *Plos One*,**5**.
- Mukabana, W. R., Takken, W., Killeen, G. F. & Knols, B. G. J. (2004) Allomonal effect of breath contributes to differential attractiveness of humans to the African malaria vector *Anopheles gambiae*. *Malaria Journal*,**3**.
- Mweresa, C. K., Omusula, P., Otieno, B., van Loon, J. J. A., Takken, W. & Mukabana, W. R. (2014) Molasses as a source of carbon dioxide for the malaria mosquitoes *Anopheles gambiae* and *Anopheles funestus*. *Malaria Journal*,**13**: 160.
- Okell, L. C., Bousema, T., Griffin, J. T., Ouedraogo, A. L., Ghani, A. C. & Drakeley, C. J. (2012) Factors determining the occurrence of submicroscopic malaria infections and their relevance for control. *Nature Communication*,**3**, 1237.

- Olanga, E. A., Okal, M. N., Mbadi, P. A., Kokwaro, E. D. & Mukabana, W. R. (2010) Attraction of *Anopheles gambiae* to odour baits augmented with heat and moisture. *Malaria Journal*,**9**.
- Oria, P. A., Hiscox, A., Alaii, J., Ayugi, M., Mukabana, W. R. & Takken, W. (2014) Tracking the mutual shaping of the technical and social dimensions of solar-powered mosquito trapping systems (SMoTS) for malaria control on Rusinga Island, western Kenya. *Parasites and Vectors*,**7**.
- Ouédraogo, A., Goncalves, B., Gneme, A., Wenger, E., Guelbéogo, M., Ouédraogo, A., *et al.* (2016) Dynamics of the human infectious reservoir for malaria determined by mosquito feeding assays and ultrasensitive malaria diagnosis in Burkina Faso. *Journal of Infectious Diseases*,**213 (1)**: 90-99.
- Roitberg, B. D., Mondor, E. B. & Tyerman, J. G. (2003) Pouncing spider, flying mosquito: blood acquisition increases predation risk in mosquitoes. *Behavioral Ecology*,**14**, 736-740.
- Saitoh, Y., Hattori, J., Chinone, S., Nihei, N., Tsuda, Y., Kurahashi, H., *et al.* (2004) Yeast-generated CO<sub>2</sub> as a convenient source of carbon dioxide for adult mosquito sampling. *Journal of the American Mosquito Control Association*,**20**, 261-264.
- Schneider, P., Schoone, G., Schallig, H., Verhage, D., Telgt, D., Eling, W., *et al.* (2004) Quantification of *Plasmodium falciparum* gametocytes in differential stages of development by quantitative nucleic acid sequence-based amplification. *Molecular and Biochemical Parasitology*,**137**, 35-41.
- Shieh, J. & Rossignol, P. (1992) Opposite influences of host anaemia on blood feeding rate and fecundity of mosquitoes. *Parasitology*,**105**: 159-163.
- Smallegange, R. C., Schmied, W. H., van Roey, K. J., Verhulst, N. O., Spitzen, J., Mukabana, W. R., *et al.* (2010) Sugar-fermenting yeast as an organic source of carbon dioxide to attract the malaria mosquito *Anopheles gambiae*. *Malaria Journal*,**9**.
- Smallegange, R. C., van Gemert, G. J., van de Vegte-Bolmer, M., Gezan, S., Takken, W., Sauerwein, R. W., *et al.* (2013) Malaria infected mosquitoes express enhanced attraction to human odor. *Plos One*,**8**.

- Smith, D., Perkins, T., Reiner, R., Barker, C., Niu, T., Chaves, L., *et al.* (2014) Recasting the theory of mosquito-borne pathogen transmission dynamics and control. *Transactions of the Royal Society of Tropical Medicine and Hygiene*, **108**(4): 185-197.
- Smith, D. L., Dushoff, J. & McKenzie, F. E. (2004) The risk of a mosquito-borne infection in a heterogeneous environment. *PLoS Biology*, **2**(11): e368.
- Snounou, G., Viriyakosol, S., Zhu, X. P., Jarra, W., Pinheiro, L., Dorosario, V. E., *et al.* (1993) High-sensitivity of detection of human malaria parasites by the use of nested polymerase chain-reaction. *Molecular and Biochemical Parasitology*, **61**, 315-320.
- Van Den Abbeele, J., Caljon, G., De Ridder, K., De Baetselier, P. & Coosemans, M. (2010) *Trypanosoma brucei* modifies the tsetse salivary composition, altering the fly feeding behavior that favors parasite transmission. *Plos Pathogens*, **6**.
- Verhulst, N. O., Mbadi, P. A., Kiss, G. B., Mukabana, W. R., van Loon, J. J. A., Takken, W., *et al.* (2011a) Improvement of a synthetic lure for *Anopheles gambiae* using compounds produced by human skin microbiota. *Malaria Journal*, **10**.
- Verhulst, N. O., Qiu, Y. T., Beijleveld, H., Maliepaard, C., Knights, D., Schulz, S., *et al.* (2011b) Composition of human skin microbiota affects attractiveness to malaria mosquitoes. *Plos One*, **6**.
- Verhulst, N. O., Takken, W., Dicke, M., Schraa, G. & Smallegange, R. C. (2010) Chemical ecology of interactions between human skin microbiota and mosquitoes. *Fems Microbiology Ecology*, **74**, 1-9.
- Wheeler, D. & Tiefelsdorf, M. (2005) Multicollinearity and correlation among local regression coefficients in geographically weighted regression. *Journal of Geographical Systems*, **7**: 161-187.
- WHO. (2015) *World Malaria Report 2015*. WHO, Geneva: Switzerland.
- WWARN, W. A. R. N. (2016) Gametocyte carriage in uncomplicated *Plasmodium falciparum* malaria following treatment with artemisinin combination therapy: a systematic review and meta-analysis of individual patient data. *BMC Medicine*, **14**, 1-18.

Supplementary Figures and Tables

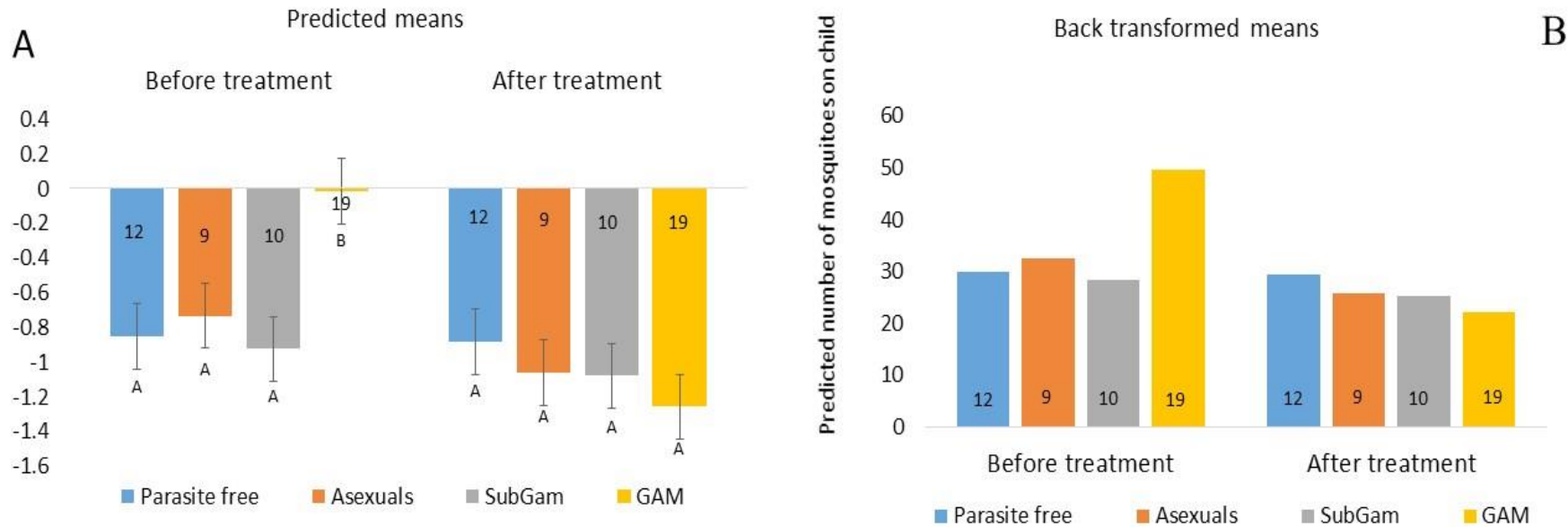

Figure S.1. Effect of parasitological status and sampling moment on mosquito attraction to children in a dual-choice olfactometer. Panel A: Predicted means are derived from the generalized linear mixed model (GLMM) including parasitological status ( $P < 0.001$ ), sampling moment ( $P < 0.001$ ) and their interaction ( $P < 0.001$ ), as well as haemoglobin level ( $P = 0.005$ ) and date ( $P < 0.001$ ) as fixed effect terms, and participant as a random effect term. Statistically significant pairwise comparisons are indicated by different letters above bars (see Table S.1 for pairwise standard error of the difference (SEDs)). Panel B: Back-transformed values of predicted means from the GLMM on the original scale of number of mosquitoes per child. (Parasite-free, asexual, sub/microscopic carriers of *P. falciparum* are now and hereafter labelled as parasite-free, Asexuals, SubGam or GAM, respectively).

Table S.1. Matrix of pairwise standard errors of the differences (SEDs) between predicted means of number of mosquitoes attracted to children of four parasitological categories and two sampling moments (before and after antimalarial treatment). Statistical comparisons were made within sampling moment between parasitological categories, and between sampling moment within parasitological categories. Other pairwise comparisons were considered irrelevant and are indicated by n/a. SEDs are derived from the GLMM (figure S.1). Significant pairwise differences ( $P < 0.05$ ) were made by multiplying SEDs by 2 (the 2.5 % t-value) and comparing to the difference between predicted means, and are indicated in bold font.

Sampling moment	Parasitological status								
Before	Parasite-free	*							
	Asexuals	0.2875	*						
	SubGam	0.292	0.2889	*					
	GAM	<b>0.2597</b>	<b>0.2572</b>	<b>0.2376</b>	*				
After	Parasite-free	0.2541	n/a	n/a	n/a	*			
	Asexuals	n/a	0.2757	n/a	n/a	0.2808	*		
	SubGam	n/a	n/a	0.2527	n/a	0.278	0.2937	*	
	GAM	n/a	n/a	n/a	<b>0.1906</b>	0.2469	0.264	0.2406	*
		Parasite-free	Asexuals	SubGam	GAM	Parasite-free	Asexuals	SubGam	GAM
	Before				After				

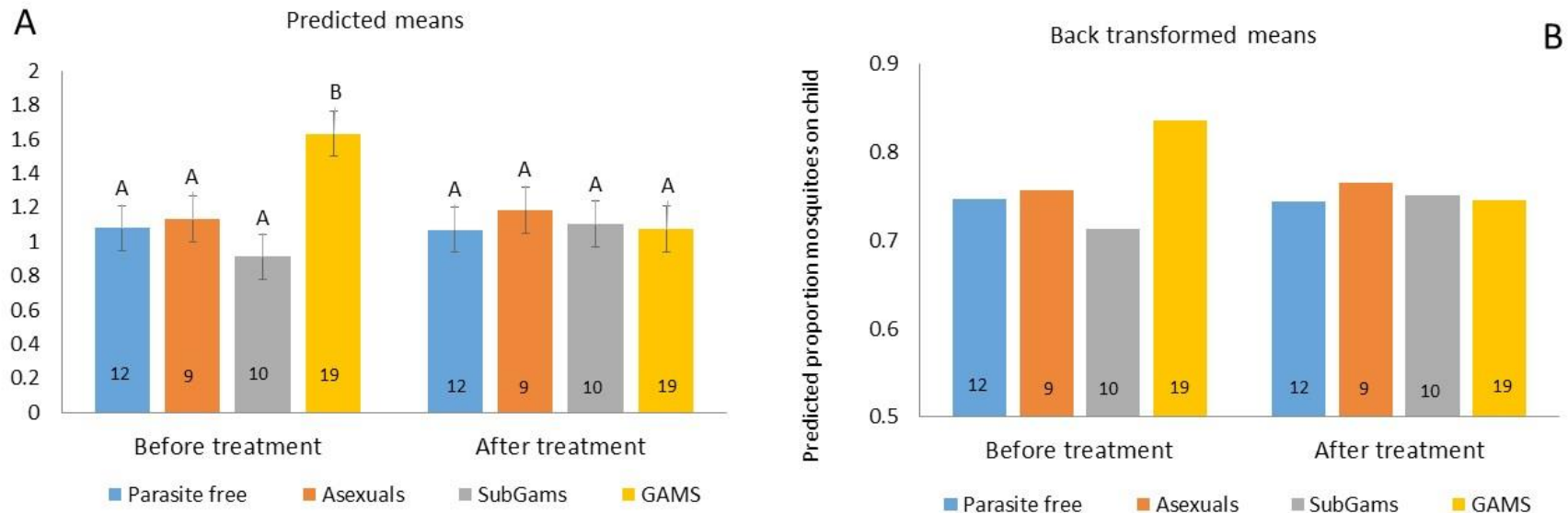

Figure S.2. Effect of parasitological status and sampling moment on the proportion of mosquitoes attracted to children in a dual-choice olfactometer. Panel A: Predicted means derived from the generalized linear mixed model (GLMM) including parasitological status ( $P = 0.004$ ), sampling moment ( $P = 0.052$ ) and their interaction ( $P < 0.001$ ), as well as date ( $P = 0.007$ ) as fixed effect terms, and participant as a random effect term. Significant pairwise comparisons are indicated by different letters above bars (see Table S.2 for pairwise SEDs). Panel B: Back-transformed values of predicted means from the GLMM on the original scale.



Table S. 2. Matrix of pairwise standard errors of the differences (SEDs) between predicted means of the proportion of mosquitoes attracted to children of four parasitological categories and two sampling moments (before and after antimalarial treatment). Statistical comparisons were made within sampling moment between parasitological categories, and between sampling moment within parasitological categories. Other pairwise comparisons were considered irrelevant and are indicated by n/a. SEDs are derived from the GLMM (figure S.2). Significant pairwise differences ( $P < 0.05$ ) were made by multiplying SEDs by 2 (the 2.5 % t-value) and comparing to the difference between predicted means, and are indicated in bold font.

Sampling moment	Parasitological status								
Before	Parasite-free	*							
	Asexuals	0.196	*						
	SubGam	0.193	0.201	*					
	GAM	<b>0.172</b>	<b>0.18</b>	<b>0.165</b>	*				
After	Parasite-free	0.131	n/a	n/a	n/a	*			
	Asexuals	n/a	0.155	n/a	n/a	0.204	*		
	SubGam	n/a	n/a	0.134	n/a	0.199	0.215	*	
	GAM	n/a	n/a	n/a	<b>0.097</b>	0.176	0.193	0.175	*
		Parasite-free	Asexuals	SubGam	GAM	Parasite-free	Asexuals	SubGam	GAM
	Before				After				

## Chapter 6

Mechanisms of manipulation of human attractiveness by  
*Plasmodium* parasites

Annette O. Busula, Tessa S. van Dijk, Niels O. Verhulst,  
Collins Mweresa, Willem Takken and Jetske G. de Boer

Parts of this chapter will be submitted in modified form

## Abstract

Body odour is an important host-seeking stimulus for mosquitoes, and recent work shows that skin bacteria mediate the production of odorous volatiles that guide host-seeking mosquitoes to their specific hosts. Interestingly, infection with *Plasmodium* parasites influences mosquito host selection by making gametocyte carriers more attractive to mosquito vectors leading to the question of whether this change in attractiveness results from changes in body odour and/or the skin microbial volatiles. In this study, dual-choice cage assays were conducted to determine the relative preference of *Anopheles gambiae sensu stricto* for body odours and skin bacterial volatiles from children that were naturally infected with *Plasmodium falciparum* before and after antimalarial treatment. *Anopheles gambiae* mosquitoes were attracted more to volatiles from socks worn by infected children than to volatiles from socks worn by the same children after antimalarial treatment, irrespective of parasite stage. The response to body odours from parasite-free children remained stable between the two sampling moments. Infection with *P. falciparum* did not affect mosquito responses to volatiles from cultured skin microbes. It is concluded that *Plasmodium* parasites manipulate body odours of carriers of both asexual and sexual parasite stages, increasing their attractiveness to malaria vectors. Identification of chemical compounds responsible for the attraction of volatiles from infected children could lead to tools for rapid malaria diagnosis as well as the improvement of the effectiveness of existing odour-baited traps.

## Introduction

Several studies show that host characteristics such as physical and chemical stimuli influence the attractiveness of humans to malaria mosquitoes (Qiu & van Loon, 2010; Takken & Verhulst, 2013). These include gender, body surface area, ABO blood group type, diet, consumption of alcohol, weight, pregnancy status and host age. Carbon dioxide (CO<sub>2</sub>) and body odour of the host are particularly important in host-seeking of the anthropophilic mosquito, *Anopheles gambiae sensu stricto* (hereafter referred to as *An. gambiae*) (Takken, 1999; Takken & Knols, 2010). Human odour comprises of volatile organic compounds (VOCs), which together with CO<sub>2</sub> are detected by *An. gambiae* through odorant receptors (Carey *et al.*, 2010). Some VOCs can be detected from a distance as far as 70 meters from the source (Gillies, 1980; Carey & Carlson, 2011; Chaisson & Hallem, 2012), while others may be more important in initiating a landing response on the host (Healy & Copland, 2000; Healy *et al.*, 2002).

Differential attractiveness in humans has been explained by differences in chemical composition of their odour profile (Takken, 1999; Mukabana *et al.*, 2002; Omolo *et al.*, 2013), which can partly be explained by differences in skin microbial composition (Verhulst *et al.*, 2009), and genetic differences between individuals (Fernández-Grandon *et al.*, 2015). Skin bacteria play an important role in guiding malaria vectors towards their blood-meal hosts (Verhulst *et al.*, 2009, and Chapter 3) because skin exudates can be converted to VOCs by skin microbiota (Braks & Takken, 1999). The unique bacterial composition on human skin (Grice *et al.*, 2009; Fierer *et al.*, 2010) has a great impact on the variety in VOCs produced on the skin, hence variation in human attractiveness to mosquitoes (Verhulst *et al.*, 2010). Indeed, humans that are highly attractive to *An. gambiae* have a higher abundance but lower diversity of bacteria on their skin than poorly attractive individuals (Verhulst *et al.*, 2011b), supporting the role of skin bacteria in mediating olfactory preference of malaria mosquitoes. Skin bacteria and the volatiles they produce are therefore an important link between malaria vectors and humans (Verhulst *et al.*, 2010).

Differential attractiveness in humans suggests that some humans are at higher risk of being bitten by mosquitoes than others, which may lead to differences in infection rates with parasites (Lindsay *et al.*, 1993; Logan *et al.*, 2008). Unattractive humans are likely protected to some extent against infective mosquito bites, which may contribute to higher fitness (Snow *et al.*, 2005). Logan *et al.* (2008) further suggested that reduced attractiveness could be a result of emission of higher levels of specific volatiles by humans that either mask their attractiveness to mosquitoes or are repellent to mosquitoes (Chapter 3). Besides a possible association between intrinsic attractiveness and infection risk, parasite infections may also change host attractiveness leading to increased contact rates between vector and infectious hosts.

Several studies show that infection with malaria parasites indeed influences mosquito host-selection (Lacroix *et al.*, 2005; Cornet *et al.*, 2013; Batista *et al.*, 2014; De Moraes *et al.*, 2014), making infected hosts more attractive to mosquitoes than parasite-free individuals. In a mouse model, high attraction to *An. stephensi* was seen during chronic infection with *Plasmodium chabaudi* (De Moraes *et al.*, 2014) and compounds of bacterial origin such as 2- and 3-methyl butanoic acid (Verhulst *et al.*, 2009) were associated with increased attractiveness (De Moraes *et al.*, 2014). Human individuals infected with *P. falciparum* gametocytes attracted about two times more *An. gambiae* mosquitoes than asexual carriers of *P. falciparum* or children without malaria. After anti-malarial treatment, increased attractiveness of former gametocyte carriers disappeared (Lacroix *et al.*, 2005, and Chapter 5). These *in vivo* studies, using children to attract malaria mosquitoes, support the role of gametocytes in mosquito attraction but were not designed to study the possible mechanisms of parasite manipulation (Chapter 4).

The present study therefore examined potential mechanisms of manipulation. First, we investigated whether body odour is responsible for the differential attraction to *P. falciparum*-infected children observed in Chapter 5. Because of the important role of skin bacteria in mosquito attraction, we also determined the effect of *P. falciparum* parasites and gametocytes on attractiveness of bacterial volatiles derived from human skin.

## **Materials and methods**

### **Sample collection**

#### *Study participants*

A total of 46 children aged 5-12 years was recruited to collect body odour and bacterial samples to test the effect of *P. falciparum* infection on attractiveness to malaria mosquitoes. Infected children were selected based on microscopy, while the presence of submicroscopic levels of gametocytes was detected by NASBA, as described in Chapter 5. Sensitive 18S qPCR was used to categorize parasite-free children. This resulted in 12 parasite-free children, 7 carriers of asexual parasite stages, 8 submicroscopic gametocyte carriers and 19 microscopic gametocyte carriers. Presence and absence of *P. falciparum* in all children was confirmed by nested PCR (Snounou *et al.*, 1993; Baidjoe *et al.*, 2013), and levels of total parasites and mature gametocytes were assessed by 18S qPCR (Hermsen *et al.*, 2001) and NASBA (Schneider *et al.*, 2004).

Samples were collected at two moments: on the day children were recruited, just following the administration of the first dose of antimalarial medication (further referred to as before antimalarial treatment) and 21 days after malaria treatment (further referred to as after antimalarial treatment).

Antimalarial treatment was done according to recommendations of the WHO, with weight-dosed artemisinin-lumefantrine containing 20 mg artemisinin/120 mg lumefantrine per tablet (Coartem-D™; Novartis, Basel, Switzerland) (WHO, 2015). At the second sampling moment the same children were tested for presence of malaria parasites by microscopy and molecular methods. Age of children, haemoglobin level, weight and body temperature were measured also before and after antimalarial treatment (Chapter 5). The study protocol (NON SSC 389) was approved by the Scientific and Ethical Review Committee of the Kenya Medical Research Institute (KEMRI) (KEMRI/RES/7/3/1).

#### *Procedures for collection of body odour and skin bacteria*

Body odours and skin bacteria were collected on nylon socks and cotton pads respectively. Before use, nylon socks (97% polyamide, 3% elastane, 20 denier, Hema, The Netherlands) were washed by soaking and swirling them in an open glass container filled with 70%

ethanol. They were then squeezed and placed on clean aluminium foil in a ventilated oven to dry at 70°C for two h, while turning them a few times. Pre-treatment of cotton pads (100% cotton, 5 cm diameter, Hema, The Netherlands) was done by placing them in a large glass dish filled with n-hexane (100%, Merck; Darmstadt, Germany) and then transferring to another glass container filled with methanol (100%, Sigma-Aldrich, Steinheim, Germany) in a fume hood. The cotton pads were squeezed and placed in an oven at 100°C for two h to dry. Each cleaned and dried pair of socks and cotton pads was subsequently placed in a pre-cleaned jar, which was tightly closed and kept at room temperature until use. Glass jars and lids were cleaned with tap water and 70% ethanol. The jars were dried in an oven at 150°C for 24 h while the lids were dried at room temperature. Pieces of aluminium foil were lined inside lids of the glass jars to prevent contact between the plastic cap and the sample. Surgical gloves were worn during all sample collection and experimental procedures to avoid contamination with human odour.

After the children had participated in the olfactometer assay described in Chapter 5, a pair of nylon socks was placed on their feet, and two cotton pads were lined on their lower back using one sterile 10 × 15 cm island plaster (HEKA<sup>®</sup>plast, Van Heek medical, The Netherlands). A piece of aluminium foil was placed between the two pieces of cotton pads and the island plaster (Verhulst *et al.*, 2016). Nylon socks and cotton pads were removed after approximately 20 h, and stored in clean glass jars at -20°C until use in cage assay experiments. Children were asked not to shower during the time they wore nylon socks and cotton pads but had no other behavioural restrictions. Nylon socks of all 46 children at both time points were included in the cage assays described below, while skin bacterial volatiles of 29 children were selected for the tests, *i.e.* 7 parasite-free children, 5 asexual carriers, 3 submicroscopic gametocyte carriers and 14 microscopic gametocyte carriers.

### **Behavioural assay**

A dual choice cage assay first described by (Okal *et al.*, 2013), was modified to determine the preference of mosquitoes for VOCs from socks worn by the same individual either before or after antimalarial treatment. To avoid the effect of non-human odour from soiled socks, the foot part of all worn socks was cut off before the experiment was conducted.

This study was conducted under ambient conditions, in a red fluorescent-lit experimental room (average temperature, 24.1°C), at *icipe*-Thomas Odhiambo Campus (TOC), Mbita Point. Three WHO bioassay tubes (12.5 cm long, 5 cm wide) (WHO, 2006) were connected with slide units between the inner and outer tubes. Mosquito cages (15×15×15 cm) were wrapped with transparent kitchen cling-film (Chandaria industries limited, Kenya) and the outer tubes were inserted into the cages, at a distance of approximately 6 cm. A pair of nylon socks, worn by one study participant before antimalarial treatment was placed in one cage, while the other pair of socks of the same individual, worn after antimalarial treatment was placed in the second cage (figure 1).

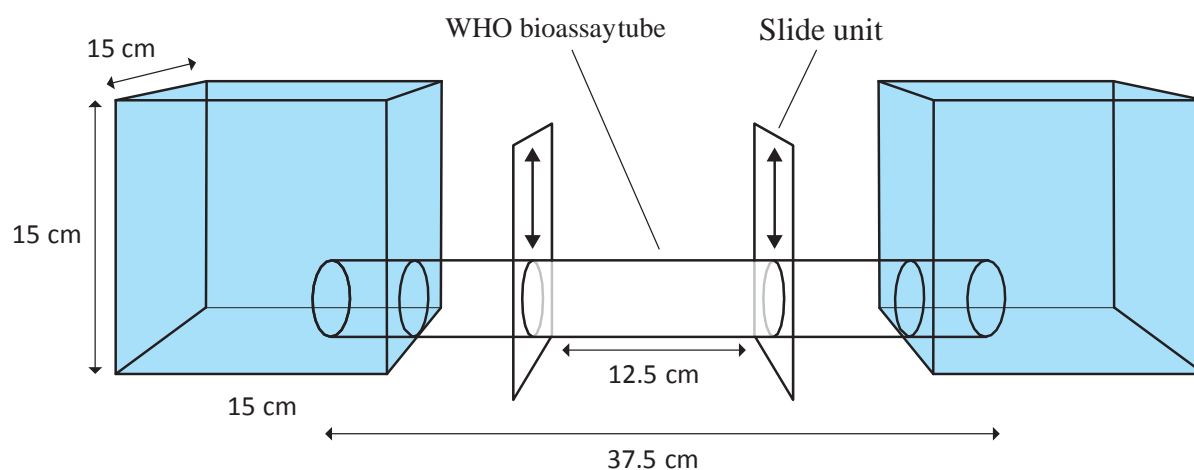

Figure 1. Schematic drawing of the cage assay set up used to test the response of *An. gambiae* to VOCs from human worn nylon socks or their skin bacteria. Two mosquito cages wrapped with kitchen cling-film were connected with three WHO bioassay tubes (WHO, 2006), with slide units between the inner and outer tubes. Each cage contained a pair of socks or a bacterial plate, with samples from the same child collected before or after antimalarial treatment offered in a dual-choice situation. Ten female mosquitoes were released in the central tube and given 15 min. to fly to either cage.

A group of 350 female *An. gambiae* mosquitoes (Mbita strain), 6-8 d old, which had not received a blood meal, were randomly collected eight h before the start of the experiment. Mosquito rearing was done following methods described in Chapters 3 and 5. Collected mosquitoes were kept in a 15 cm cubic mesh-covered cage without access to sugar water but with access to filtered water from Lake Victoria provided on wet cotton wool placed on top of the cage. Groups of ten randomly selected mosquitoes were used in each dual-cage set up. They were released into the central WHO tube (WHO, 2006) and the gates of the



tubes were fully opened for 15 min. to allow mosquitoes to fly towards odours from either pair of worn socks. During experiments, the cage set ups were covered with black cotton cloths. After 15 min., the gates were closed, socks were removed and stored in the freezer at -20°C.

The bio-assay tubes were removed and the cages sealed with cling film to prevent mosquitoes escaping. Mosquitoes were counted and recorded the following morning. The same sets of socks from the same child were replicated six times under the same conditions on different experimental nights, in different experimental set-ups, and their positions were rotated between the left or right cage over replicates to minimize any positional effects. Per experimental night (18.30 h – 22.30 h), two rounds of testing were conducted with a maximum of 18 cage set ups in parallel. A new cage set-up with new cling film, bioassay tubes and cages, (pre-cleaned with 70% ethanol) were used for every new group of mosquitoes.

A second dual choice cage-assay experiment was conducted using the same set up, to evaluate the differences in host-seeking responses to VOCs produced by bacteria from non-infected and naturally infected children. In preparation of the behavioural experiment, bacterial plates were made from the cotton pads of the first and second sampling moment of the same volunteer (before and after antimalarial treatment). Each cotton pad was cut into three equal pieces (for a total of six pieces per sampling moment per volunteer) and for every experiment one piece was placed on a five cm TSA (Bacto, USA) plate. Phosphate-buffered saline (PBS, 1 mL) was added whereupon the agar was wiped ten times with both sides of the cotton pad to transfer the bacteria from the pad onto the agar. The plates were incubated at 34°C for 30 h, which should allow for sufficient bacterial growth to result in attractive volatiles for mosquitoes (Verhulst *et al.*, 2009). The number of colony forming units (cfu's) was counted on each plate before the behavioural experiment.

The two bacterial plates per individual, one of each sampling moment (before and after treatment with antimalarials), were placed in the cages connected to a dual-choice set up (figure 1). Procedures used in the sock experiment were utilised in testing attractiveness

of the bacterial plates. In total, six replicates per individual were performed on six different days, with new bacterial plates for each replicate made from the six pieces of cotton pad (see above). On each day there were three rounds with ten individuals tested in parallel per round in ten identical set-ups. Positions of bacterial plates of individuals and the two sampling moments were rotated between set-ups and rounds over days. A new set up with new cling film, pre-cleaned bioassay tubes and cages were used for every new group of mosquitoes.

### **Statistical analysis**

We first used a generalized linear model (GLM) to predict per individual child the attractiveness of socks worn before antimalarial treatment, relative to the total mosquitoes caught, over six replicates (binomial distribution and logit link function, dispersion estimated).

Participant was included in the model to obtain predictions per child, and day effect was included because it was significant ( $P_{\text{day}} = 0.019$ ). 95% confidence intervals of predicted preference were used to determine whether mosquito choice deviated from a 50:50 distribution to socks worn before or after antimalarial treatment.

The effect of parasitological status (parasite-free, asexual, submicroscopic or microscopic gametocytes) on attractiveness of body odours (worn nylon socks) and skin bacterial volatiles was then tested. We hypothesized that body odour or skin bacterial volatiles collected from *P. falciparum* infected children before antimalarial treatment would be more attractive than volatiles of the same individuals after antimalarial treatment, and that this effect is specifically caused by gametocytes. A GLM with binomial distribution and logit link function was used with the mosquitoes caught on the sample taken before antimalarial treatment as the response variable, and total mosquitoes caught in both cages as the binomial total. Dispersion was estimated. Covariates associated with the set-up (day, time, set-up, sample position) and volunteers (age, gender, and haemoglobin level and body temperature measured before antimalarial treatment) were included in the model when they were significant ( $P < 0.05$ ).

Pairwise comparisons between predicted means of main parasitological status groups were done following GLM using least significant differences (Wheeler & Tiefelsdorf, 2005). In addition, we tested whether within parasitologically positive samples, gametocyte density (using three levels: absent, submicroscopic and microscopic) or density of total parasites as measured by 18S qPCR influenced preference of mosquitoes for body odour collected before antimalarial treatment. This was done by using these two continuous explanatory variables in two separate GLMs.

The effect of parasitological status on mosquito attraction to skin bacterial volatiles was analysed with a GLM following the same methods as in the analyses of body odour. The effect of bacterial density on mosquito choice was analysed in a separate model. Bacterial densities were transformed to ranks before analyses because they were highly variable and not normally distributed. The ratio of bacterial densities between the two sampling moments ( $\text{cfu}'_{\text{S}(\text{before})}/\text{cfu}'_{\text{S}(\text{after})}$ ) was used as an explanatory variable.

The effect of parasitological status and sampling moment (before versus after antimalarial treatment) on rank-transformed bacterial densities was analysed with a generalized linear mixed model (GLMM, normal distribution, identity link function). Parasitological status, sampling moment and their interaction were used as fixed effect terms, and participant as a random effect term. Other covariates (day) were included in the model when significant. All data were analysed in GenStat v. 18 (VSN International, U.K.).

## Results

### *Effect of Plasmodium falciparum infection on mosquito attraction to body odour*

The overall response of *An. gambiae* mosquitoes in the cage assay to socks was high, with approximately 90% of released mosquitoes caught within 15 min. Mosquito preference for the sock worn before antimalarial treatment compared to the sock worn after treatment varied from 46% to 76% for the individual participants. The mosquitoes did not differentiate between socks worn by any of the parasite-free children at the two sampling moments (GLM,  $P > 0.05$ ,  $N = 12$ ). One child of the group with asexual parasite stages ( $N = 7$ ), three children of the submicroscopic gametocyte group ( $N=8$ ), and seven children of the gametocyte group

(N = 19) were significantly more attractive before antimalarial treatment compared to after antimalarial treatment (GLM, 95% confidence intervals). No children were significantly more attractive after antimalarial treatment compared to before antimalarial treatment (GLM, 95% CI).

We then investigated the effect of parasitological status and covariates associated with children on mosquito preference with a GLM. Preference for body odour before versus after antimalarial treatment was significantly affected by parasitological status (figure 2, GLM,  $P < 0.001$ ), but not by age, gender, body temperature or haemoglobin level before antimalarial treatment (GLM, all  $P > 0.05$ ). Day of testing was included in this model because it significantly influenced mosquito preference (GLM,  $P_{\text{day}} = 0.014$ ). Mosquitoes significantly preferred body odour collected from carriers of asexual stages of *P. falciparum* and both groups of gametocyte carriers before antimalarial treatment compared to body odour of the same individuals collected after treatment (figure 2, GLM, 95 % CI). The proportion of mosquitoes attracted to volatiles from parasite-free children at the two sampling moments did not differ significantly from 50% (GLM, 95% CI). Pairwise comparisons of parasitological status groups showed that mosquito preference for socks worn before antimalarial treatment of both asexual carriers and the two groups of gametocyte carriers differed significantly from mosquito preference for socks worn by parasite-free children (GLM, pairwise comparisons,  $P < 0.05$ , see supplementary figure S.1 and Table S.1).

Within the three groups of parasitologically positive children, there was no effect of gametocyte level (absent, submicroscopic or microscopic, fitted as a continuous variable, GLM,  $P = 0.131$ ) or density of total parasites measured by 18S qPCR (GLM,  $P = 0.696$ ) on mosquito preference for body odour before antimalarial treatment.

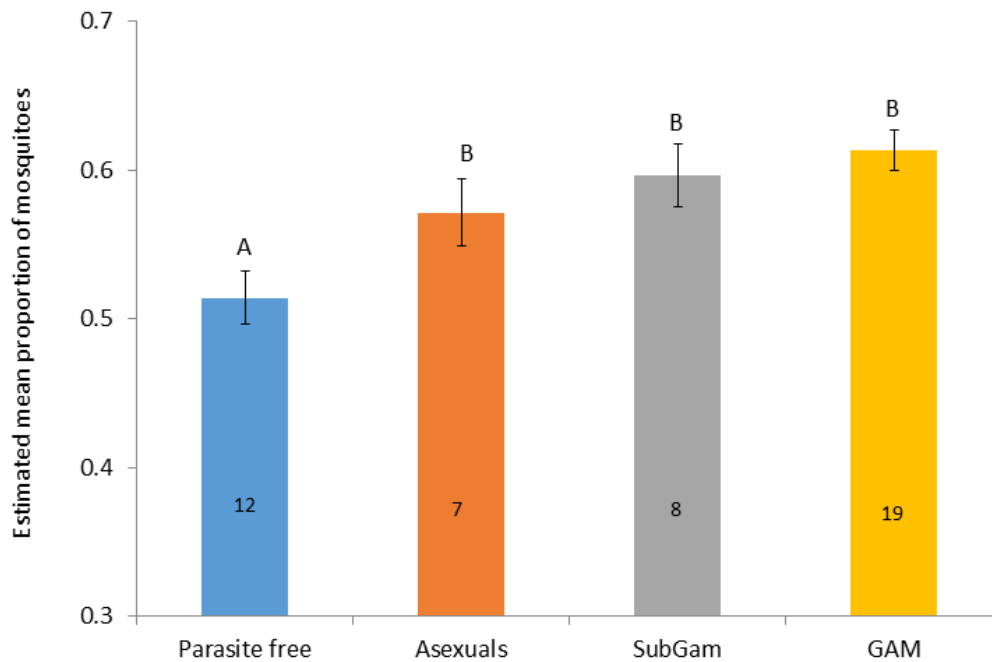

Figure 2. Effect of parasitological status on mosquito preference for body odour before relative to after antimalarial treatment. Back-transformed estimated means from the GLM are plotted with standard errors, and significant differences from 0.5 are indicated with \* ( $P < 0.05$ ). Different letters above bars indicate significant differences in choice between parasitological status groups (GLM,  $P_{\text{status}} < 0.001$ ,  $P_{\text{day}} = 0.014$ , see supplementary material Table S.1 for pairwise standard errors of the difference). Numbers in bars represent the number of individual children in each malaria status group. Groups of ten mosquitoes were given a choice between socks worn by each participant at both sampling moments (before and after antimalarial treatment of infected children) in a cage assay, with six replicates per participant.

#### *Effect of P. falciparum infection on mosquito response to skin bacterial volatiles*

As with body odour, mosquito responses in the cage assay to skin bacterial volatiles were high, with more than 95% of released mosquitoes caught within 15 min. Mosquito choice between volatiles of skin bacteria collected before versus after antimalarial treatment was highly variable, and varied between 32% to 68% for the 29 individual participants. Skin bacterial volatile of none of the participants was significantly more attractive before than after antimalarial treatment (GLM, 95% CI), while skin bacterial volatiles of one gametocyte carrier were more attractive after than before antimalarial treatment. Bacterial densities on agar plates were also highly variable and significantly

affected by the interaction between parasitological status and sampling moment (GLMM,  $P = 0.012$ ), although not by the terms on their own ( $P_{\text{status}} = 0.590$ ,  $P_{\text{sampling moment}} = 0.379$ , supplementary material Table S.2).

Parasitological status did not affect mosquito preference between skin bacterial volatiles of the two sampling moments (Figure 3, GLM,  $P_{\text{status}} = 0.780$ ;  $P_{\text{position}} < 0.001$ ,  $P_{\text{round}} = 0.018$ ), and indeed mean mosquito choice was statistically similar to 50% for all four groups of children (GLM, 95% CI). Finally, mosquito choice was not affected by bacterial densities in this experiment, using the ratio of bacterial densities between the two sampling moments as an explanatory variable ( $P_{\text{cfu's(before)/cfu's(after)}} = 0.884$ ;  $P_{\text{position}} < 0.001$ ,  $P_{\text{round}} = 0.029$ ).

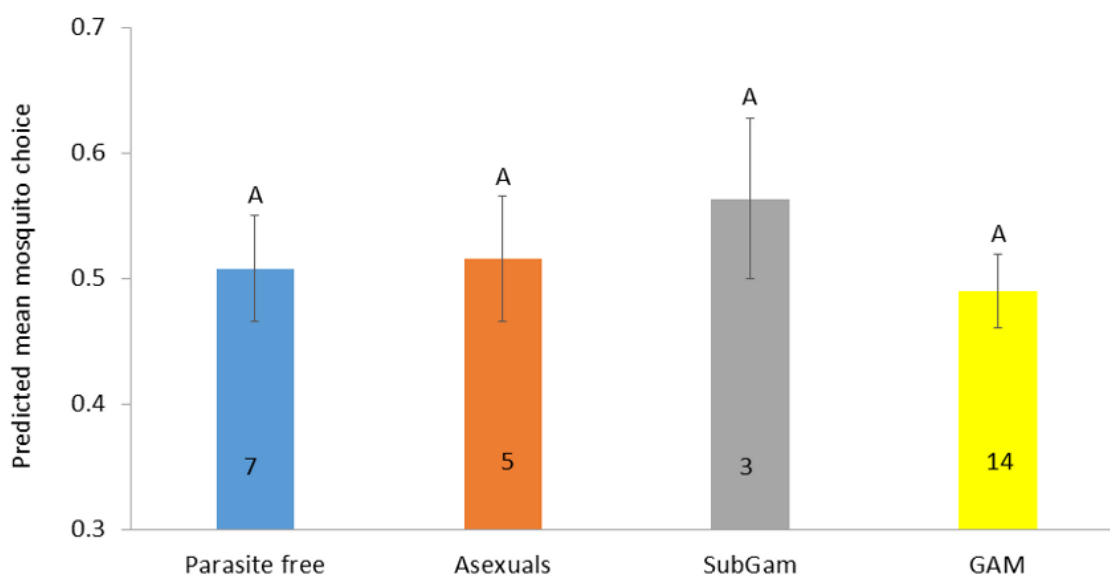

Figure 3. Effect of parasitological status on mosquito preference for volatiles from skin bacteria collected before antimalarial treatment relative to volatiles from skin bacteria collected after treatment. Back-transformed estimated means from the GLM are plotted with standard errors. Numbers in bars represent the number of individual children in each parasitological status group. Groups of ten mosquitoes were given a choice between plated skin bacteria from each participant at both sampling moments (before and after antimalarial treatment of infected children) in a cage assay, with six replicates per participant ( $P_{\text{status}} = 0.78$ ;  $P_{\text{time}} = 0.018$  and  $P_{\text{position}} < 0.001$ ).

## Discussion

Volatiles from carriers of malaria parasites, both asexual and sexual stages, were significantly more attractive to *An. gambiae* mosquitoes at the time of infection than after treatment. There was no difference in mosquito response between volatiles from skin bacteria from parasite-free and malaria-infected children. These seemingly contrasting results are explained in the discussion below.

Many studies show that odour influences the choice of host-seeking mosquitoes e.g. (Njiru *et al.*, 2006; Omolo *et al.*, 2013; Takken & Verhulst, 2013) and human odour is considered universally as an important cue guiding mosquitoes to their host.

Evidence that parasites change host-odours resulting in increased attractiveness to mosquitoes is accumulating (Lacroix *et al.*, 2005; Batista *et al.*, 2014; De Moraes *et al.*, 2014, and Chapter 5). In the present study, mosquitoes significantly preferred body odours of one child with asexual stages, three children with submicroscopic gametocytes and seven with microscopic gametocytes before versus after antimalarial treatment. Hence, when considering mosquito preferences to odour samples of individual participants, this suggests a stronger effect on mosquito behaviour at higher gametocyte levels. However, the overall results showed that infection with *Plasmodium* parasites significantly increased attractiveness of body odours *in vitro* from all parasitologically positive children before treatment, irrespective of parasite stage and density. This effect was independent of age (within the tested range of 5-12 years old), gender or haemoglobin level of children. This finding is in contrast with our hypothesis that mosquito preference would be mediated specifically by transmissible gametocytes, based on previous *in vivo* olfactometer experiments (Lacroix *et al.*, 2005, and Chapter 5). These studies, conducted *in vivo*, used total emanations of children (breath combined with body odour) and showed that children infected with microscopic gametocytes attracted about two times more mosquitoes than children without high levels of gametocytes.

Our findings leave an open question why in the *in vivo* experiment (Chapter 5) with carriers of asexual parasite stages or children with submicroscopic gametocytes were not different from parasite-free children, and in the *in vitro* assay with the skin volatiles on socks they

were significantly more attractive than the parasite-free group. The most likely explanation for the difference in our *in vivo* and *in vitro* experiments may be the presence of breath in the experiment with children as compared to the experiment with socks. Breath was also present in addition to body odour in studies on malaria parasite mediated differences in mosquito attraction to birds and mice (Cornet *et al.*, 2013; De Moraes *et al.*, 2014). Mosquito attraction to breath has received little attention compared to mosquito responses to body odour. In fact, one study demonstrated a stronger response of *An. gambiae* to body odours compared to total emanations (breath and body odour) from two healthy human volunteers, suggesting that breath may suppress mosquito attraction rather than contribute to it (Mukabana *et al.*, 2004). On the other hand, breath odour profiles have been shown to change during *P. falciparum* infection (Berna *et al.*, 2015), and another study showed that *P. falciparum* cultures produce specific compounds that may be emitted through the breath (Kelly *et al.*, 2015). It is therefore important to follow up on the role of breath in the attraction of *Anopheles* mosquitoes to gametocytaemic humans.

Changes in body odour, due to disease in humans (Penn & Potts, 1998), can enhance attraction of mosquitoes to infected hosts, and this may depend on the life-cycle stage of the parasite (Cornet *et al.*, 2013; Batista *et al.*, 2014; De Moraes *et al.*, 2014). Because several studies show that skin bacteria mediate odour production (Braks & Takken, 1999, and Chapter 3; Verhulst *et al.*, 2009; Verhulst *et al.*, 2011a; Verhulst *et al.*, 2011b), we next examined whether infection with malaria parasites affects mosquito attraction to skin bacterial volatiles.

Previous studies on non-infected humans show that the density and composition of skin bacteria are correlated with the intensity of human body odour (Stoddart, 1990) and human attractiveness to mosquitoes (Verhulst *et al.*, 2011b). However, the results presented here did not show a correlation between the presence of *Plasmodium* parasites and attractiveness of skin bacterial volatiles. In addition, the number of cfu's in both groups of gametocyte carriers, carriers of asexual parasite stages and parasite-free children were highly variable and did not differ significantly. Although previous studies have shown that skin bacteria grown on plates can be used to attract malaria mosquitoes, less than 10% of all bacteria can be grown on agar plates. In addition, these plates do not resemble the human skin



as a substrate and therefore other volatiles may be produced. Although the effect of malaria parasites was not seen in the skin bacterial volatile experiment, De Moraes *et al.* (2014) showed that elevated levels of volatiles of bacterial origin in malaria-infected mice increased attractiveness to *An. stephensi*. Compounds of bacterial origin were also upregulated in a study with *P. falciparum* infected Dutch adults (de Boer *et al.*, submitted). 16s rRNA sequencing of the skin microbiota of infected and non-infected children would therefore be a next step to reveal potential differences and has been used before to correlate human attractiveness to mosquitoes with their skin microbiome (Verhulst *et al.*, 2011b).

We conclude that the blend of volatiles released from the skin changes when children carry malaria parasites, resulting in increased attractiveness of these infected children to mosquitoes. This effect was not strongly associated with gametocyte density, suggesting that additional cues contribute to differential attractiveness of microscopic gametocyte carriers observed in our previous *in vivo* study (Chapter 5). No effect of infection status on the skin bacterial density and attractiveness of skin bacterial volatiles to mosquitoes was found, although more detailed studies including 16s rRNA sequencing are required. From an applied perspective, VOC analyses of *Plasmodium*-infected humans could contribute to increase the efficiency of odour baits that may be used in trapping malaria mosquitoes (Homan *et al.*, 2016).

## References

- Baidjoe, A., Stone, W., Ploemen, I., Shagari, S., Grignard, L., Osoti, V., *et al.* (2013) Combined DNA extraction and antibody elution from filter papers for the assessment of malaria transmission intensity in epidemiological studies. *Malaria Journal*, **12**, 1.
- Batista, E. P. A., Costa, E. F. M. & Silva, A. A. (2014) *Anopheles darlingi* (Diptera: Culicidae) displays increased attractiveness to infected individuals with *Plasmodium vivax* gametocytes. *Parasites & Vectors*, **7**.
- Berna, A. Z., McCarthy, J. S., Wang, R. X., Saliba, K. J., Bravo, F. G., Cassells, J., *et al.* (2015) Analysis of breath specimens for biomarkers of *Plasmodium falciparum* infection. *Journal of Infectious Diseases*, **212**, 1120-1128.

- Braks, M. A. H. & Takken, W. (1999) Incubated human sweat but not fresh sweat attracts the malaria mosquito *Anopheles gambiae sensu stricto*. *Journal of Chemical Ecology*, **25**, 663-672.
- Carey, A. F. & Carlson, J. R. (2011) Insect olfaction from model systems to disease control. *Proceedings of the National Academy of Sciences of the United States of America*, **108**, 12987-12995.
- Carey, A. F., Wang, G. R., Su, C. Y., Zwiebel, L. J. & Carlson, J. R. (2010) Odorant reception in the malaria mosquito *Anopheles gambiae*. *Nature*, **464**, 66-U77.
- Chaisson, K. E. & Hallem, E. A. (2012) Chemosensory behaviors of parasites. *Trends in parasitology*, **28**, 427-436.
- Cornet, S., Nicot, A., Rivero, A. & Gandon, S. (2013) Malaria infection increases bird attractiveness to uninfected mosquitoes. *Ecology Letters*, **16**, 323-329.
- de Boer, J. G., Robinson, A., Powers, S. J., Burgers, S. L. G. E., Caulfield, J. C., Birkett, M. A., *et al.* (submitted) Odours of *Plasmodium falciparum*-infected participants influence mosquito-host interactions *Scientific Reports*.
- De Moraes, C. M., Stanczyk, N. M., Betz, H. S., Pulido, H., Sim, D. G., Read, A. F., *et al.* (2014) Malaria-induced changes in host odors enhance mosquito attraction. *Proceedings of the National Academy of Sciences of the United States of America*, **111**, 11079-11084.
- Fernández-Grandon, G. M., Gezan, S. A., Armour, J. A., Pickett, J. A. & Logan, J. G. (2015) Heritability of attractiveness to mosquitoes. *PloS One*, **10**, e0122716.
- Fierer, N., Lauber, C. L., Zhou, N., McDonald, D., Costello, E. K. & Knight, R. (2010) Forensic identification using skin bacterial communities. *Proceedings of the National Academy of Sciences*, **107**, 6477-6481.
- Gillies, M. T. (1980) The role of carbon dioxide in host-finding by mosquitoes (Diptera: Culicidae): a review. *Bulletin of Entomological Research*, **70**, 525-532.
- Grice, E. A., Kong, H. H., Conlan, S., Deming, C. B., Davis, J., Young, A. C., *et al.* (2009) Topographical and temporal diversity of the human skin microbiome. *Science*, **324**, 1190-1192.

- Healy, T. P. & Copland, M. J. W. (2000) Human sweat and 2-oxopentanoic acid elicit a landing response from *Anopheles gambiae*. *Medical and Veterinary Entomology*,**14**, 195-200.
- Healy, T. P., Copland, M. J. W., Cork, A., Przyborowska, A. & Halket, J. M. (2002) Landing responses of *Anopheles gambiae* elicited by oxocarboxylic acids. *Medical and Veterinary Entomology*,**16**, 126-132.
- Hermesen, C. C., Telgt, D. S. C., Linders, E. H. P., van de Locht, L., Eling, W. M. C., Mensink, E., *et al.* (2001) Detection of *Plasmodium falciparum* malaria parasites in vivo by real-time quantitative PCR. *Molecular and Biochemical Parasitology*,**118**, 247-251.
- Homan, T., Hiscox, A., Mweresa, C. K., Masiga, D., Mukabana, W. R., Oria, P., *et al.* (2016) The effect of mass mosquito trapping on malaria transmission and disease burden (SolarMal): a stepped-wedge cluster-randomised trial. *Lancet*,**388**, 1193-1201.
- Kelly, M., Su, C. Y., Schaber, C., Crowley, J. R., Hsu, F. F., Carlson, J. R., *et al.* (2015) Malaria parasites produce volatile mosquito attractants. *Mbio*,**6**.
- Lacroix, R., Mukabana, W. R., Gouagna, L. C. & Koella, J. C. (2005) Malaria infection increases attractiveness of humans to mosquitoes. *Plos Biology*,**3**, 1590-1593.
- Lindsay, S., Adiamah, J., Miller, J., Pleass, R. & Armstrong, J. (1993) Variation in attractiveness of human subjects to malaria mosquitoes (Diptera: Culicidae) in The Gambia. *Journal of medical entomology*,**30**, 368-373.
- Logan, J. G., Birkett, M. A., Clark, S. J., Powers, S., Seal, N. J., Wadhams, L. J., *et al.* (2008) Identification of human-derived volatile chemicals that interfere with attraction of *Aedes aegypti* mosquitoes. *Journal of Chemical Ecology*,**34**, 308-322.
- Mukabana, W. R., Takken, W., Coe, R. & Knols, B. G. (2002) Host-specific cues cause differential attractiveness of Kenyan men to the African malaria vector *Anopheles gambiae*. *Malaria Journal*,**1**, 17.
- Mukabana, W. R., Takken, W., Killeen, G. F. & Knols, B. G. J. (2004) Allomonal effect of breath contributes to differential attractiveness of humans to the African malaria vector *Anopheles gambiae*. *Malaria Journal*,**3**.

- Njiru, B. N., Mukabana, W. R., Takken, W. & Knols, B. G. J. (2006) Trapping of the malaria vector *Anopheles gambiae* with odour-baited MM-X traps in semi-field conditions in western Kenya. *Malaria Journal*,**5**.
- Okal, M. N., Francis, B., Herrera-Varela, M., Fillinger, U. & Lindsay, S. W. (2013) Water vapour is a pre-oviposition attractant for the malaria vector *Anopheles gambiae sensu stricto*. *Malaria Journal*,**12**.
- Omolo, M., Njiru, B., Ndiege, I., Musau, R. & Hassanali, A. (2013) Differential attractiveness of human foot odours to *Anopheles gambiae* Giles sensu stricto (Diptera: Culicidae) and variation in their chemical composition. *Acta Tropica*,**128**, 144-148.
- Penn, D. & Potts, W. K. (1998) Chemical signals and parasite-mediated sexual selection. *Trends in Ecology & Evolution*,**13**, 391-396.
- Qiu, Y. T. & van Loon, J. J. (2010) Olfactory physiology of blood-feeding vector mosquitoes. *Olfaction in vector-host interactions*, 39-61.
- Schneider, P., Schoone, G., Schallig, H., Verhage, D., Telgt, D., Eling, W., *et al.* (2004) Quantification of *Plasmodium falciparum* gametocytes in differential stages of development by quantitative nucleic acid sequence-based amplification. *Molecular and Biochemical Parasitology*,**137**, 35-41.
- Snounou, G., Viriyakosol, S., Zhu, X. P., Jarra, W., Pinheiro, L., Dorosario, V. E., *et al.* (1993) High-sensitivity of detection of human malaria parasites by the use of nested polymerase chain-reaction. *Molecular and Biochemical Parasitology*,**61**, 315-320.
- Snow, R. W., Guerra, C. A., Noor, A. M., Myint, H. Y. & Hay, S. I. (2005) The global distribution of clinical episodes of *Plasmodium falciparum* malaria. *Nature*,**434**, 214-217.
- Stoddart, D. M. (1990) *The scented ape: the biology and culture of human odour*. Cambridge University Press.
- Takken, W. (1999) Chemical signals affecting mosquito behaviour. *Invertebrate Reproduction & Development*,**36**, 67-71.
- Takken, W. & Knols, B. G. J. (2010) *Olfaction in vector-host interactions*. Wageningen Academic Publishers, Wageningen, The Netherlands.

- Takken, W. & Verhulst, N. O. (2013) Host preferences of blood-feeding mosquitoes. *Annual Review of Entomology*, **58**, 433-453.
- Verhulst, N. O., Beijleveld, H., Knols, B. G. J., Takken, W., Schraa, G., Bouwmeester, H. J., *et al.* (2009) Cultured skin microbiota attracts malaria mosquitoes. *Malaria Journal*, **8**.
- Verhulst, N. O., Mbadi, P. A., Kiss, G. B., Mukabana, W. R., van Loon, J. J. A., Takken, W., *et al.* (2011a) Improvement of a synthetic lure for *Anopheles gambiae* using compounds produced by human skin microbiota. *Malaria Journal*, **10**.
- Verhulst, N. O., Qiu, Y. T., Beijleveld, H., Maliepaard, C., Knights, D., Schulz, S., *et al.* (2011b) Composition of human skin microbiota affects attractiveness to malaria mosquitoes. *Plos One*, **6**.
- Verhulst, N. O., Takken, W., Dicke, M., Schraa, G. & Smallegange, R. C. (2010) Chemical ecology of interactions between human skin microbiota and mosquitoes. *Fems Microbiology Ecology*, **74**, 1-9.
- Verhulst, N. O., Weldegergis, B. T., Menger, D. & Takken, W. (2016) Attractiveness of volatiles from different body parts to the malaria mosquito *Anopheles coluzzii* is affected by deodorant compounds. *Scientific Reports*, **6**.
- Wheeler, D. & Tiefelsdorf, M. (2005) Multicollinearity and correlation among local regression coefficients in geographically weighted regression. *Journal of Geographical Systems*, **7**: 161-187.
- WHO. (2006) Guidelines for testing mosquito adulticides for indoor residual spraying and treatment of mosquito nets.
- WHO. (2015) *World Malaria Report 2015*. WHO, Geneva: Switzerland.

## Supplementary Material

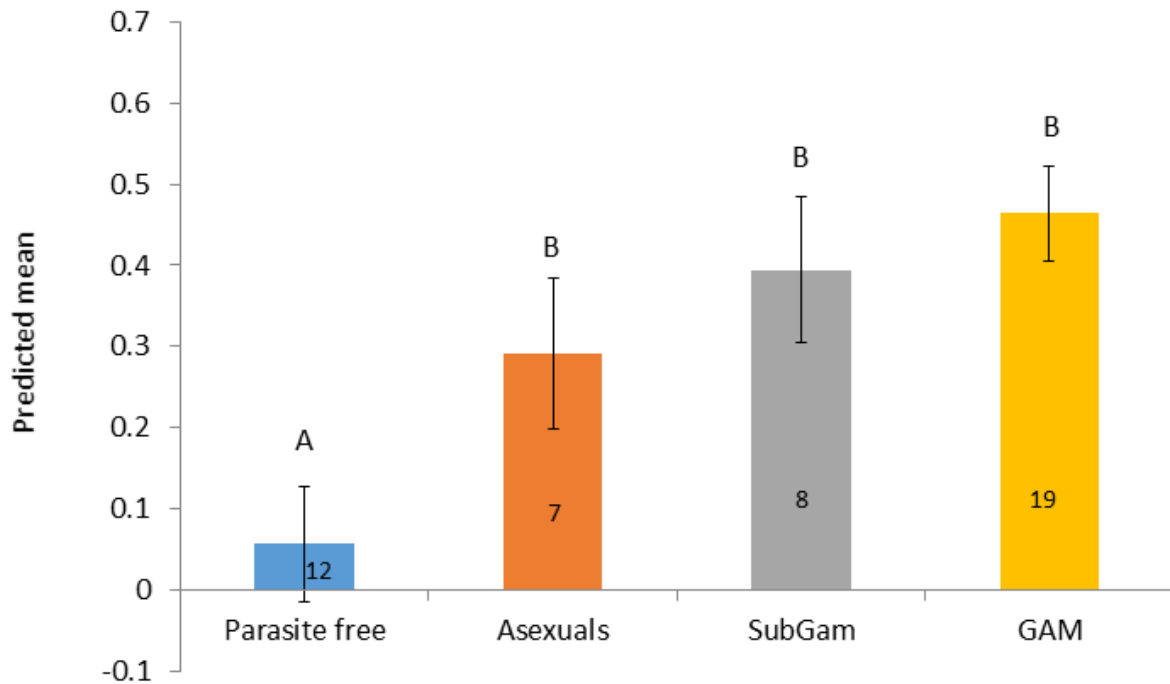

Figure S.1. Predicted mean mosquito choice between body odour before compared to after antimalarial treatment to children of four parasitological status groups in cage assays. Error bars indicate standard errors of the mean. Different letters above bars indicate significantly different means by pairwise comparisons made using least significant differences following GLM ( $P_{\text{status}} < 0.001$ ,  $P_{\text{day}} = 0.014$ ; see Table S.1). Numbers in bars refer to the number of individual tested in each group.

Table S.1. Matrix of least significant differences between pairs of parasitological status groups derived from the generalized linear model ( $P_{\text{status}} < 0.001$ ,  $P_{\text{day}} = 0.014$ ). Bold font indicates significant differences (see figure S.1).

Parasitological status				
Parasite-free	*			
Asexuals	<b>0.2316</b>	*		
SubGam	<b>0.2266</b>	0.2540	*	
GAM	<b>0.1815</b>	0.2159	0.2099	*
	Parasite-free	Asexuals	SubGam	GAM

Table S.2. Mean number of colony forming units (cfu's) on agar plates streaked with skin bacteria from parasite-free or *P. falciparum*-infected children before and after treatment with antimalarials (with range of cfu's in brackets). N indicates the number of individual children sampled per parasitological status group, while n represents the number of agar plates on which bacteria were counted (6 per child per sampling moment).

Parasitological status	Mean cfu's (minimum-maximum)		
	n	Before treatment	After treatment
Parasite-free (N=7)	42	85 (5-900)	572 (0-2000)
Asexual carriers (N=5)	30	201 (1-2000)	122 (0-420)
Submicroscopic gams (N=3)	18	60 (0-192)	372 (1-2000)
Microscopic gametocytes (N=14)	84	198 (1-2000)	85 (5-900)

## Chapter 7

### General discussion





## General discussion

It has long been known that semio-chemicals play an important role in the life of mosquitoes, and both female and male mosquitoes use these cues in their foraging behaviour. Carbon dioxide (CO<sub>2</sub>) acts as an activator and attractant for female host-seeking mosquitoes (Gillies, 1980; Mboera & Takken, 1997; Spitzen *et al.*, 2008). In addition, odours from host skin provide important cues in this behaviour (Braks & Takken, 1999), and may enable host-seeking females to differentiate between host species (Takken & Verhulst, 2013, and Chapter 2). Bacteria on the human skin are involved in the production of skin volatiles attractive to mosquitoes (Verhulst *et al.*, 2009; Verhulst *et al.*, 2010; Verhulst *et al.*, 2011c, and Chapter 3). Identification of attractive volatile organic compounds (VOCs) has led to the development of synthetic odour blends used to trap mosquitoes in the field (Okumu *et al.*, 2010; Smallegange *et al.*, 2010; Verhulst *et al.*, 2011a; Mukabana *et al.*, 2012; van Loon *et al.*, 2015; Homan *et al.*, 2016).

To date, studies of host-seeking behaviour of malaria mosquitoes have focused primarily on their responses to healthy human hosts. For a better understanding of this behaviour, it is important to know how variation in VOCs between host species and variation within humans resulting from infection with malaria parasites influences host-seeking behaviour. Moreover, the role of skin bacteria in mediating these host-seeking responses needs to be established. Although human skin bacterial volatiles are attractive to *Anopheles gambiae* (Braks & Takken, 1999; Verhulst *et al.*, 2011b), the response of this mosquito species to body odours and skin bacterial volatiles from other hosts species, as well as the response of opportunistic vectors such as *An. arabiensis* to these volatiles, are unknown.

Apart from the bacteria on the skin of the vertebrate host (Chapter 3), microorganisms inside the host can also influence mosquito blood-meal choice (Chapters 5 and 6). Parasites can alter the phenotype of their hosts to increase the probability of transmission (Thomas & Poulin, 1998; Berdoy *et al.*, 2000; Moore, 2002; Thomas *et al.*, 2005). For example, mosquito vectors carrying transmissible stages of *Plasmodium falciparum* (sporozoites) have an increased olfactory response to human odour compared to their non-infected counterparts

(Smallegange *et al.*, 2013), while infected birds or rodents carrying transmissible stages of malaria parasites (gametocytes) can become more attractive to uninfected vectors than hosts without gametocytes (Ferguson & Read, 2004; Cornet *et al.*, 2013; De Moraes *et al.*, 2014). Recent studies suggests that malaria parasites also manipulate attractiveness of infected humans to enhance transmission (Lacroix *et al.*, 2005). However, whether parasites manipulate breath or body odour of the infected host is unclear and the mechanisms involved in this manipulation also remain unknown. Therefore, there is need to study the interactions between natural hosts and their associated skin bacteria, malaria parasites, and mosquitoes with respect to host-seeking behaviour of malaria vectors.

Knowledge on these interactions could lead to an improved odour-bait that attracts malaria-vectoring mosquitoes more efficiently and/or attracts a wider range of mosquito species.

The aim of this thesis was therefore to investigate the role of *Plasmodium* parasites and skin bacteria in mediating responses of malaria vectors to body odours. Specifically, I addressed three research questions:

1. Do volatiles produced by skin bacteria play a role in species-specific host preference of mosquitoes?
2. Does infection with gametocytes of *Plasmodium* increase the attractiveness of humans to malaria mosquitoes?
3. What is the mechanism through which *Plasmodium* influences human attractiveness to malaria mosquitoes?

### **Do skin bacterial volatiles play a role in species-specific mosquito host preference?**

The anthropophilic mosquitoes *An. gambiae* and *An. funestus* primarily take blood meals from humans, while *An. arabiensis* is more opportunistic, feeding on both humans and animals (Costantini *et al.*, 1999; Tirados *et al.*, 2006; Takken & Verhulst, 2013). In Chapter 2, I showed that human odour attracted the highest numbers of *An. gambiae* in a screen house choice assay with odours from three different vertebrate host species. Adding odours of cow or chicken to CO<sub>2</sub> actually reduced the attractiveness of CO<sub>2</sub> to *An. gambiae* (Chapter 2). These results match with the anthropophilic biting behaviour of *An. gambiae*, and confirm

previous findings (Gillies, 1964; Pates *et al.*, 2001). *Anopheles arabiensis* responded most strongly to human odour as well, but was also attracted to cow and chicken odours (Chapter 2), which confirms its more opportunistic behaviour (Githeko *et al.*, 1996). Several other studies have also shown higher attraction of *An. arabiensis* to human than cow odour (Diatta *et al.*, 1998; Torr *et al.*, 2008; Lyimo *et al.*, 2013), while other studies show that *An. arabiensis* avoids non-mammalian hosts such as chickens (Githeko *et al.*, 1994; Mnzava *et al.*, 1994; Kassahun *et al.*, 2016), although this is dependent on the set up.

The selective host-seeking behaviour of malaria mosquitoes in Chapter 2 of this thesis may be explained by nutritional variation in the blood-meals of different host types (Lyimo & Ferguson, 2009). Human odour was most preferred by the anthropophilic mosquitoes, which suggests its specialization on some of the host's blood contents. The response of the mosquitoes with an opportunistic host preference to odours from several host species suggests its attraction to common/general VOCs produced by the hosts. Additionally, the presence of unattractive host volatiles may explain observed differential behaviour between the two species. For example, 6-methyl-5-hepten-2-one (MHO), a general compound identified in headspace volatiles of sheep, cattle and goat, did not affect the attraction of *An. arabiensis* (McBride *et al.*, 2014; Kassahun *et al.*, 2016), but negatively influenced the oviposition preference of *An. coluzzii* (formerly known as *An. gambiae* M molecular form) (Suh *et al.*, 2016). People with lower emission rates of MHO were most attractive to *Aedes aegypti* while higher emission rates of the compound masked attractiveness of humans (Logan *et al.*, 2008). It may therefore be possible that MHO did not increase the attractiveness of cow and chicken odour or bacterial volatiles from these hosts in this thesis (Chapter 2 and 3), although additional studies on concentrations of MHO versus mosquito response need attention. Importantly, comparative headspace analyses of the odour profile of host species in my study need to be done in order to address this topic further (see future perspectives).

My field experiments confirmed the screen house findings, and in addition showed that the synthetic MB5 odour bait was more attractive to some mosquito species than to others (Chapter 2). Mweresa *et al.* (2014) reported significant attractiveness of the same synthetic

blend to *An. arabiensis* and *An. funestus* in the field, and a large field trial on Rusinga Island-Kenya demonstrated that MB5-baited traps can significantly reduce the densities of *An. funestus* (Homan *et al.*, 2016). Despite the reduction in the *An. funestus* population, there is need to optimize the synthetic odour blend to enable higher catches of a wider range of mosquito species because secondary vectors may become more important in malaria transmission when primary species are successfully controlled (Sriwichai *et al.*, 2016, and see future perspectives).

After demonstrating that *An. gambiae* and *An. arabiensis* indeed have different preferences for volatiles of three species of vertebrate hosts (Chapter 2), I investigated whether volatiles from skin bacteria influence the interaction between vertebrate hosts and these two mosquito species (Chapter 3). Results of Chapter 3 support those of Chapter 2, which show that both mosquito species preferred odours from human skin bacteria to those of chicken or cow, while *An. arabiensis* was more opportunistic as it responded to odours from human animal skin bacteria. This study therefore shows that skin bacterial volatiles can guide mosquitoes with different host preference to their specific host (figure 1), *i.e.* *An. gambiae* responds more specifically to specific bacterial species and to VOCs from bacteria of human origin than *An. arabiensis*, which appears to use volatiles that are generally produced by skin bacteria to locate its hosts (Chapter 3). Moreover, the opportunistic nature of feeding on both animals and humans (Costantini *et al.*, 1996) may explain the equal response of *An. arabiensis* to odours from four bacterial species (Chapter 3), although response of this mosquito species is dependent on the study area (geographical region). In order to know which specific bacterial species mediate attractiveness of each host species, future studies should focus on sequencing of skin bacteria from the three hosts. Further, analysis of the skin bacterial volatiles will also provide information on the abundance of specific or general bacterial compounds present on skin of various host species. Additionally, experiments using different strains of existing malaria mosquito species (from various populations) need to be conducted in order to draw conclusions on mosquito host preference, as the mosquitoes respond differently to host volatiles, based on their country of origin/geographical set up.

In addition to their role in host-seeking of malaria vectors, VOCs from bacteria are known to mediate oviposition behaviour of gravid *Aedes aegypti* and *Ae. Albopictus* females (vectors of

yellow fever, dengue, chikungunya and Zika viruses) (Hasselschwert & Rockett, 1988; Ponnusamy *et al.*, 2010; Ponnusamy *et al.*, 2015). Interestingly, 3-methyl-1-butanol, a common and abundant attractive volatile obtained from *Klebsiella pneumoniae* and *Citrobacter freundii*, is also an oviposition attractant for *An. gambiae* s.l. (Lindh *et al.*, 2008; Himeidan *et al.*, 2013). This compound, a component of the odour blend, Mb5 (Menger *et al.*, 2014b) also increases malaria vector and other African mosquito species trap catches, both in the semi- and field set ups (Verhulst *et al.*, 2011a; Mukabana *et al.*, 2012; van Loon *et al.*, 2015). On vertebrate skin, bacteria modify/convert some aromatic amino acids, fatty acids or carbohydrates that are larger and less volatile into smaller, smellier, detectable VOCs (Schulz & Dickschat, 2007). Because of their important role in mosquito behaviour, VOCs from bacteria have high potential to play an important role in vector control (see future perspectives).

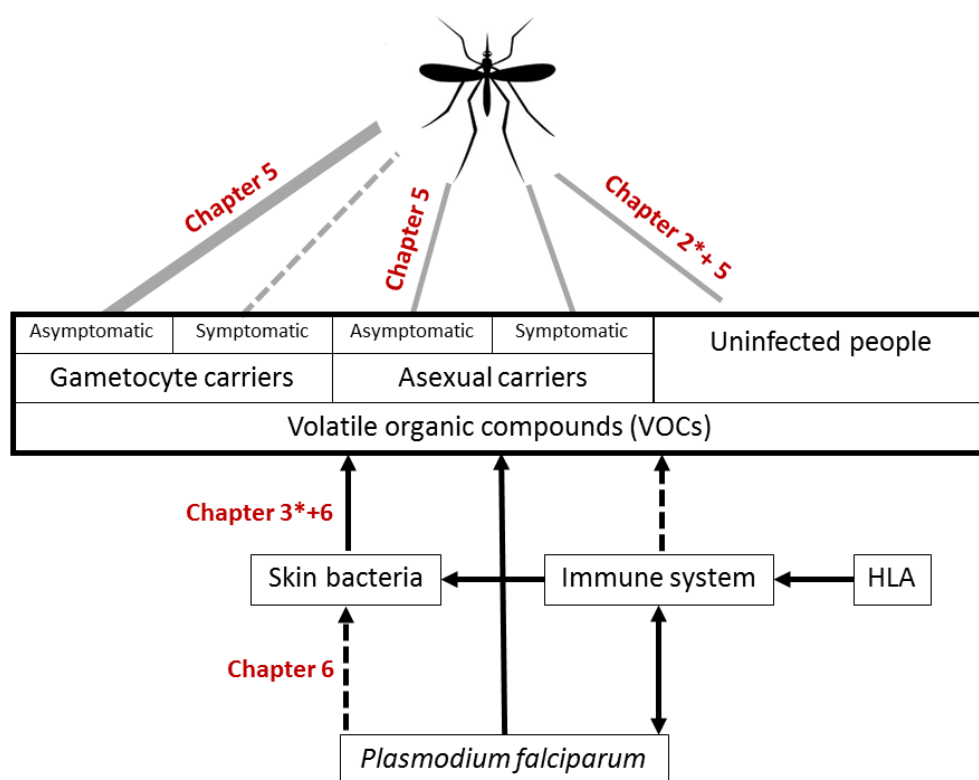

Figure 1. Factors that influence the production of VOCs from non-infected and malaria-infected humans and the thesis chapters in which they were studied. Solid and broken lines represent confirmed and hypothesized relationships. Attractiveness of mosquitoes to VOCs from humans infected with different stages of malaria is shown by the thickness of the grey lines. \* also tested for non-human host species (cows and chickens). (Figure adapted from Chapter 4).

### **Does infection with *Plasmodium*-gametocytes increase attractiveness of humans to *An. gambiae* s.s.?**

Manipulation of attractiveness of the vertebrate host by malaria parasites would increase contact rates between infected hosts and mosquito vectors, thus enhancing parasite transmission (Chapter 4). It is therefore expected that humans who harbour the transmissible, gametocyte, stage of malaria parasites attract significantly higher numbers of mosquitoes than those without gametocytes; parasite-free or those infected with the non-transmissible stage of the parasite, asexual carriers. I tested the attractiveness of naturally infected children in a dual-choice olfactometer (figure 1). Indeed, when microscopic gametocytes were present during infection, mosquitoes responded more strongly (about two times) to odours from gametocyte carriers than to odours from children without microscopic gametocytes (Chapter 5). After treatment with antimalarials, the attractiveness of children who previously harboured gametocytes at microscopic levels, dropped significantly to the same level of attractiveness of parasite-free children, children with asexual stages of *P. falciparum*, or children with submicroscopic levels of gametocytes. Responses of *An. gambiae* to children without gametocytes at microscopic levels did not differ significantly between the two time sampling moments. These results show that higher attractiveness was strongly associated with high densities of gametocytes, *i.e.* above the detection threshold of microscopy and match those of Lacroix *et al.* (2005), who reported that about twice as many *An. gambiae* mosquitoes were attracted to children infected with *P. falciparum* gametocytes compared to carriers of asexual stages or non-infected children, and that mosquitoes did not differentiate between children after antimalarial treatment. The two studies show that asymptomatic but infectious humans are more attractive, hence likely to receive more mosquito bites than non-infectious people. Interestingly, higher gametocyte densities also result in higher infectiousness to malaria mosquitoes (Churcher *et al.*, 2013). Low gametocyte densities of around one gametocyte per  $\mu\text{l}$  blood (considered as sub-microscopic) lead to low percentages of mosquitoes becoming infected (around 4% *An. gambiae*), but higher gametocyte densities (detectable by microscopy) of more than 200 gametocytes per  $\mu\text{l}$  blood lead to substantially higher infection rates (up to 20% of mosquitoes). Therefore, there

is an association between high gametocyte densities in humans, higher attractiveness to malaria vectors and a rapid increase in mosquito infection (Churcher *et al.*, 2013, and Chapter 5), which is expected to impact on models of malaria transmission considerably.

Thus, an infection with high densities of *Plasmodium* gametocytes in humans increases host attractiveness to malaria vectors, which suggests that people with high gametocytaemia could contribute disproportionately to malaria transmission, as they are likely bitten more often than their non-gametocytaemic counterparts and also infect mosquitoes at a higher rate, hence have a considerably higher chance of passing on the parasites to non-infected mosquitoes.

In order to confirm that gametocytaemic humans are indeed bitten more as a result of increased attractiveness, people in the same household could be tested for the presence of gametocytes, while mosquitoes could be collected from the same household the following morning. Genotyping of mosquito blood-meals would reveal the contact rates of mosquitoes with specific household members (Mukabana *et al.*, 2002). This would eventually reveal which of the household members received most mosquito bites. It is also important to investigate whether my finding applies more generally to interactions between gametocytaemic people and malaria vectors, particularly because secondary vector species are becoming increasingly important in Sub-Saharan Africa (Russell *et al.*, 2011). I expect that, like *An. gambiae*, the anthropophilic *An. funestus* also discriminates between people harbouring asexual stages or gametocytes, as well as parasite-free humans, as both species rely on human-specific olfactory cues to locate their blood-meal host (Homan *et al.*, 2016). Because the *P. falciparum* cue is likely an exaggeration of a pre-existing host cue (deceptive signaling), it is likely to affect other malaria vectors that are known to use human odour as host-seeking cues, but this requires further studies.

Taking an evolutionary perspective, the findings of Chapter 5 contrast with those in a system consisting of an aphid vector, *Micromyzus kalimpongensis* Basu, that causes cardamom bushy dwarf virus (CBDV) in *Elettaria cardamomum* plants (Ghosh *et al.*, 2016). Virus-infected plants are more attractive to aphid vectors and this has a beneficial effect on aphid fitness. In my study system (Chapter 5), increased attractiveness of the host (gametocyte



carriers) is not likely to benefit the vector (mosquito). In fact, *Plasmodium* parasites may have a negative fitness impact on the vector during its development, where its motivation to get blood-meals and reproduce is decreased at the oocyst stage (Wekesa *et al.*, 1992; Anderson *et al.*, 1999; Cator *et al.*, 2013; Cator *et al.*, 2014). Despite such possible negative fitness consequences, mosquitoes were lured to the infectious hosts (Chapter 5). *Plasmodium* parasites have apparently a strong evolutionary capability to manipulate their arthropod hosts to their own advantage, regardless of negative fitness effects. Infection with *Plasmodium* parasites has been suggested to induce upregulation of the existing host-seeking cues, which could deceive malaria mosquitoes and result in increased attractiveness of infected vertebrate hosts (Mauck *et al.*, 2010).

### **How may *Plasmodium* influence human attractiveness to malaria mosquitoes?**

Evidence is accumulating that infection with parasites results in increased attractiveness of vertebrate hosts. De Moraes *et al.* (2014) showed increased attractiveness of *Plasmodium*-infected mice with high gametocyte levels, while more mosquito bites were also reported in chronically infected birds (Cornet *et al.*, 2013). Additionally, human adults who harboured *P. vivax*-gametocytes were more attractive to *An. darlingi* than their non-gametocytaemic counterparts (Batista *et al.*, 2014), and children infected with microscopic levels of *P. falciparum* gametocytes were approximately twice as attractive to *An. gambiae* than those without gametocytes (Lacroix *et al.*, 2005), Chapter 5). However, these studies did not address the question whether increased attractiveness results from changes in total emanations (a combination of body and breath volatiles), body odour only or breath volatiles only. To date, only a single study with mice investigated the composition of total emanations of gametocytaemic vertebrates (De Moraes *et al.*, 2014). These researchers identified five compounds (during the chronic stage) that played a significant role in attractiveness of mosquitoes.

I conducted dual-choice cage assays to determine the role of body odour in mosquito responses to individual children before and after treatment with antimalarials. Attractiveness of socks worn by uninfected children did not differ significantly between the two moments,

corroborating results of *in vivo* experiments with parasite-free children when total body emanations were used (Lacroix *et al.*, 2005, and Chapter 5).

As expected, *An. gambiae* responded more strongly to body odours of microscopic gametocyte carriers before antimalarial treatment compared to body odour of the same children after they received medication, which is in line with increased attractiveness of total emanations of gametocytaemic children in *in vivo* experiments (Lacroix *et al.*, 2005, and Chapter 5). In addition, a significantly higher number of mosquitoes was attracted to body odours from asexual carriers and children with submicroscopic gametocytes before treatment than after medication, although no difference in attractiveness at the two time points was reported in *in vivo* studies (Lacroix *et al.*, 2005, and Chapter 5). This shows that both asexual and sexual stages of malaria parasites can change body odours resulting in increased host attractiveness in the *in vitro* but not the *in vivo* assays (figure 1). Interestingly, this also suggests that changes in body odour alone were not sufficient to result in differential attractiveness in the olfactometer studies, and that changes in breath of microscopic gametocyte carriers likely contributed to the observed strong change in attractiveness of this group. Alternatively, the cage assay may be more sensitive to small differences in skin volatiles within the same child at two infection moments. Additionally, *Plasmodium*-infection in humans may induce production of short-range volatiles that malaria mosquitoes respond to or are sensitive to, compared to VOC's from uninfected humans. In the cage assay, the distance between the mosquitoes and volatiles from the worn socks was much smaller (less than 50 cm) compared to the olfactometer or screen house set-ups. Smallegange *et al.* (Smallegange *et al.*, 2012) also found differences in response of mosquitoes in two set-ups, *i.e.* in an olfactometer (The Netherlands) using the basic blend (ammonia, L-lactic acid and tetradecanoic acid) and in the semi field (Kenya), using similar volatile blends, with an addition of a few compounds to the basic blend, and explained these differences by dimension of the set-up. Indeed, spatial scale can determine whether mosquito responses to specific volatiles in addition to an attractive blend are increased or decreased (Smallegange *et al.*, 2012). In addition, mosquito species or colony used in experiments could also explain differences in their response to volatiles.

The mechanisms involved in manipulation of human attractiveness by malaria parasites were not addressed previously (figure 1). In Chapter 4, the hypothesis was developed that infection with malaria parasites may influence skin microbial composition, leading to changes in body odour. Indeed, skin microbial composition influences attractiveness

of body odour from healthy humans (Verhulst *et al.*, 2011c), and attractiveness of different host species to malaria mosquitoes (Chapter 3). However, the attractiveness of skin bacterial volatiles from parasite-free and *Plasmodium*-infected children did not differ in a cage-assay (Chapter 6). Nevertheless, this does not preclude a role of skin bacterial volatiles in *Plasmodium*-mediated attraction of mosquitoes as agar and artificial medium are very selective in growths of bacteria.

Unlike the human skin, far fewer bacterial species will have grown on our agar plates, which may have affected the attractiveness of the bacterial volatiles to mosquitoes. Therefore, sequencing of the skin microbiota of *Plasmodium*-infected and parasite-free children is needed to examine the effect of *Plasmodium*-infection on skin microbiota in more detail. 16S-rRNA-sequencing can be used to reveal skin bacterial composition, bacterial diversity and species abundance. This may further provide information on whether *P. falciparum*-infected humans have unique skin bacterial species compared to their non-infected counterparts.

### **Future perspectives**

As pointed out in the sections above, findings in my thesis have led to the identification of future research areas that can provide information on mosquito-host-microorganisms interactions (figure 1), which are discussed here.

### **Mechanisms of *Plasmodium*-mediated host attractiveness**

#### *Analysis and identification of skin bacterial volatiles from Plasmodium-infected hosts (gametocyte carriers)*

Mosquito species coexist in nature and different mosquito species respond differently to host odours (Chapter 2). It is therefore important to determine the preference of mosquito species other than *An. gambiae* to *Plasmodium*-infected (asexual and gametocyte carriers) and uninfected people (as in Chapter 5). Follow up of the uninfected and *Plasmodium*-infected (carriers of asexual stages and gametocyte carriers) children throughout their infection cycle and analysis of their skin bacterial profiles is important to determine mechanisms involved in attractiveness of the gametocyte carriers. However, this is impossible due to the ethical

implications of leaving malaria-infected individuals untreated. Therefore, a mouse model similar to that used by De Moraes *et al.* (2014) to determine differences in the skin bacterial profiles of *Plasmodium*-infected and parasite-free mice would be more suitable to follow up on the relationship between

*Plasmodium*, skin bacteria and mosquito response throughout infection (figure 1). In such experiments, it would be important to monitor the response of mosquitoes (anthropophilic and opportunistic) to *Plasmodium chabaudi*-infected mice versus mice infected with parasites other than *Plasmodium* (controls) to determine whether the observed changes in mosquito responses are *Plasmodium*-specific or caused by a generic immune response in the vertebrate host. Differences/similarities in composition of VOCs between uninfected and infected hosts would be determined (figure 1). The analyses of volatiles in the bacterial headspace that would be collected at all infection stages of mice with *Plasmodium* versus non-malaria parasites, together with results from mosquito behaviour experiments, can lead to identification of attractive compounds and the associated bacterial species. This will show similarities or differences in attractiveness of hosts infected with different parasites, which is needed to use the information obtained in this thesis in fine-tuning of mathematical models of malaria transmission. Additionally, the information may figure out the mechanisms of manipulation, which could perhaps be informative on the evolution of manipulation.

#### *Identification of attractive human-breath volatiles from gametocytaemic humans*

Results of the cage assay strongly support a role of body odour in *Plasmodium*-mediated host attractiveness, but differences between the cage assays (Chapter 6) and the *in vivo* olfactometer studies point at an additional role of breath in the observed attractiveness of microscopic gametocyte carriers. Breath has received little attention as a source of mosquito host-seeking cues, other than CO<sub>2</sub>. Mukabana *et al.* (Mukabana *et al.*, 2004) reported a stronger response of malaria mosquitoes to body odours compared to total emanations from two healthy human volunteers, suggesting that breath may suppress mosquito attraction to parasite-free hosts. In search of bio-markers for malaria-infection, Kelly *et al.* (2015) and Berna *et al.* (2015) showed the presence of thioethers and terpenes in cultures of *P. falciparum* and breath volatiles of *Plasmodium*-infected humans, respectively.

Terpenes are generally known as plant-produced compounds (Bohlmann & Keeling, 2008) and have not been investigated much as host-seeking cues for malaria vectors. However, they play a role in the behaviour of numerous plant-feeding insects (Courtois *et al.*, 2016) and, as mosquitoes also feed on plants, may be recognized by mosquitoes. Interestingly, the same terpene identified in *P. falciparum* cultures, limonene, was also identified in healthy chicken odour profiles, and has been found to repel host-seeking *An. arabiensis* (Kassahun *et al.*, 2016). Likewise, the role of thioethers in mosquito host-seeking is not known and could provide an interesting avenue of further research. Similar to my studies on the attractiveness of body odours, there is need to collect breath volatiles and test the attractiveness of breath volatiles from uninfected humans, carriers of asexual stages and gametocyte carriers.

This will reveal whether malaria parasites manipulate breath composition leading to enhanced mosquito attraction to microscopic gametocyte carriers.

#### *Test manipulation mechanisms in arbovirus-infected hosts or parasites other than Plasmodium*

Infection with pathogens can influence the attractiveness of hosts to their vectors. The parasites manipulate their vertebrate hosts to make them more attractive to their vectors, which enhances transmission of the parasites. This has been reported in *Leishmania infantum*-infected hamsters (O'Shea *et al.*, 2002), lambs infected with Rift Valley fever virus (RVF) (Turell *et al.*, 1984), chickens infected with Sindbis virus (SINV) (Mahon & Gibbs, 1982), *P. chabaudi*- or *P. berghei*-infected mice (Day *et al.*, 1983; De Moraes *et al.*, 2014), SINV-infected young birds (Scott *et al.* 1988). and, recently, for bank voles infected with *Borrelia afzelii*, a tick-borne pathogen (van Duijvendijk *et al.*, 2016). The mechanisms of manipulation have, however, not been addressed in any of these systems. *Culex* and *Aedes* mosquitoes, as well as sand-flies and other non-malaria vectors bite humans, and some of these vectors are currently important in epidemics of vector-borne diseases, such as Zika. It is thus important to study the behaviour of these mosquitoes, *i.e.* their preference for infected or uninfected hosts, and the mechanisms involved in manipulation by their associated parasites and viruses, as this may clarify whether the effects are general for all pathogenic microorganisms.

Results of the suggested studies, together with results of this thesis (Chapters 5 and 6) may also determine whether the attractiveness of the vertebrate hosts is truly caused by the *Plasmodium*-manipulation phenomenon, or the observed changes are an outcome of upregulation of the immune system.

A mouse-virus-vector system (Zouache *et al.*, 2014) could be used to study strategies of manipulation on hosts, by specific viruses. Virus could be injected in healthy mice, and response of different mosquito species, including malaria mosquitoes, to body odour with and without breath of infected mice would be monitored. Volatiles need to be collected from breath and skin of the mice and analysed for identification of compounds produced by the infected and uninfected mice. Behavioural experiments using *Culex*, *Aedes* and malaria mosquitoes would reveal attractive compounds to the mosquito species. This can provide additional information and evidence for general/common attractive compounds for *Plasmodium*- and virus-vectors.

### **Improvement of odour baits**

Of the three natural host species used in my experiments, humans were most attractive (Chapters 2 and 3) to mosquitoes. However, *An. arabiensis* also responded to cow and chicken odour. At microscopic levels, gametocytes increased the attractiveness of *Plasmodium*-infected children (Chapter 5). Further, analyses of volatiles from a human, a cow and a chicken can lead to the identification of compounds that enable mosquitoes to distinguish between different host species and between parasite-free humans, carriers of asexual or sexual (gametocytes) stages of *P. falciparum* using a combination of gas chromatography and mass spectrometry (Kassahun *et al.*, 2016). Compounds that would be identified may be tested for their attractiveness to mosquitoes with different host preferences to ensure that primary and secondary malaria vectors are attracted (Homan *et al.*, 2016). Together with the attractive compounds that could be identified from a mouse model system, as described above, and behavioural assays, a standardized synthetic blend that would attract mosquitoes with different host preferences could be developed. An additional effect of an improved, standardized synthetic odour blend could be trapping of nuisance biters and arthropod vectors other than mosquitoes.

Future studies should also focus on sequencing of skin bacteria using 16S-rRNA (Faith, 1992; Verhulst *et al.*, 2011c; Salter *et al.*, 2014) of the three host species (cow, chickens and humans) and on non-infected, sub/microscopic gametocyte and carriers of asexual stages of *Plasmodium* parasites. This will provide information on bacterial diversity and abundance and the specific or general volatile compounds produced by different skin microbes. Analysis of skin volatiles of gametocytaemic, parasitaemic and parasite-free Kenyan children, as well as sequencing for skin bacterial profiles of the children is ongoing (Robinson *et al.* in preparation). Research on link(s) between skin microbial populations, *Plasmodium*, virus infections and attractiveness to mosquitoes with different host preferences is therefore expected to lead to improvement of the existing odour-baits (Homan *et al.*, 2016) and development of new mosquito attractants and other methods for protection against malaria vectors, and other mosquito-borne diseases.

## **Conclusions**

In conclusion, this thesis has shown that: i) mosquitoes with different host preferences respond differently to odours from different hosts and their associated skin bacterial volatiles, ii) *Plasmodium falciparum* gametocytes play a significant role in increased attractiveness of infected humans, and iii) body odours are partially responsible for increasing attractiveness of gametocyte carriers (figure 1), but also change in children carrying asexual stages. Future research should focus on: a) the provision of information on mechanisms of host manipulation by pathogens/parasites, as this may lead to a better understanding of how the vertebrate host-pathogens-vector biological system operates and b) improvement of the synthetic odour blend MB5 (Menger *et al.*, 2014a; Homan *et al.*, 2016), or development of a standardized odour blend from attractive bacterial volatiles identified from different host species, carriers of asexual parasite stages, gametocyte carriers and parasite-free humans. Improved odour blends may be used as a strategy for control of malaria and other vector-borne diseases.



## References

- Anderson, R. A., Koellaf, J. & Hurd, H. (1999) The effect of *Plasmodium yoelii nigeriensis* infection on the feeding persistence of *Anopheles stephensi* Liston throughout the sporogonic cycle. *Proceedings of the Royal Society of London B: Biological Sciences*, **266**, 1729-1733.
- Batista, E. P. A., Costa, E. F. M. & Silva, A. A. (2014) *Anopheles darlingi* (Diptera: Culicidae) displays increased attractiveness to infected individuals with *Plasmodium vivax* gametocytes. *Parasites & Vectors*, **7**.
- Berdoy, Manuel, Webster, J. P. & Macdonald, D. (2000) Fatal attraction in rats infected with *Toxoplasma gondii*. *Proceedings of the Royal Society of London B: Biological Sciences*, **267**, 1591-1594.
- Berna, A. Z., McCarthy, J. S., Wang, R. X., Saliba, K. J., Bravo, F. G., Cassells, J., *et al.* (2015) Analysis of breath specimens for biomarkers of *Plasmodium falciparum* infection. *Journal of Infectious Diseases*, **212**, 1120-1128.
- Bohlmann, J. & Keeling, C. (2008) Terpenoid biomaterials. *The Plant Journal*, **54 (4)**: 656-669.
- Braks, M. A. H. & Takken, W. (1999) Incubated human sweat but not fresh sweat attracts the malaria mosquito *Anopheles gambiae sensu stricto*. *Journal of Chemical Ecology*, **25**, 663-672.
- Cator, L. J., George, J., Blanford, S., Murdock, C. C., Baker, T. C., Read, A. F., *et al.* (2013) 'Manipulation' without the parasite: altered feeding behaviour of mosquitoes is not dependent on infection with malaria parasites. *Proceedings of the Royal Society B-Biological Sciences*, **280**.
- Cator, L. J., Lynch, P. A., Thomas, M. B. & Read, A. F. (2014) Alterations in mosquito behaviour by malaria parasites: potential impact on force of infection. *Malaria Journal*, **13**.
- Churcher, T. S., Bousema, T., Walker, M., Drakeley, C., Schneider, P., Ouedraogo, A. L., *et al.* (2013) Predicting mosquito infection from *Plasmodium falciparum* gametocyte density and estimating the reservoir of infection. *Elife*, **2**.
- Cornet, S., Nicot, A., Rivero, A. & Gandon, S. (2013) Malaria infection increases bird attractiveness to uninfected mosquitoes. *Ecology Letters*, **16**, 323-329.

- Costantini, C., Gibson, G., Sagnon, N. F., Torre, A. D., Brady, J. & Coluzzi, M. (1996) Mosquito responses to carbon dioxide in B West African Sudan savanna village. *Medical and Veterinary Entomology*,**10**, 220-227.
- Costantini, C., Sagnon, N. F., Torre, D. & Culluzzi, M. (1999) Mosquito behavioral aspects of vector–human interactions in the *Anopheles gambiae* complex *Parasitologia*,**41**, 209-217.
- Courtois, E. A., Dexter, K. G., Paine, C. E. T., Stien, D., Engel, J., Baraloto, C., *et al.* (2016) Evolutionary patterns of volatile terpene emissions across 202 tropical tree species. *Ecology and Evolution*,**6**, 2854-2864.
- Day, J. F., Ebert, K. M. & Edman, J. D. (1983) Feeding patterns of mosquitoes (Diptera: Culicidae) simultaneously exposed to malarious and healthy mice, including a method for separating blood meals from conspecific hosts. *Journal of Medical Entomology*,**20**, 120-127.
- De Moraes, C. M., Stanczyk, N. M., Betz, H. S., Pulido, H., Sim, D. G., Read, A. F., *et al.* (2014) Malaria-induced changes in host odors enhance mosquito attraction. *Proceedings of the National Academy of Sciences of the United States of America*,**111**, 11079-11084.
- Diatta, M., Spiegel, A., Lochouart, L. & Fontenille, D. (1998) Similar feeding preferences of *Anopheles gambiae* and *An. arabiensis* in Senegal. *Transactions of the Royal Society of Tropical Medicine and Hygiene*,**92 (3)**:270-272.
- Faith, D. P. (1992) Conservation evaluation and phylogenetic diversity. *Biological conservation*,**61**, 1-10.
- Ferguson, H. M. & Read, A. F. (2004) Mosquito appetite for blood is stimulated by *Plasmodium chabaudi* infections in themselves and their vertebrate hosts. *Malaria Journal*,**3**.
- Ghosh, A., Das, A., Vijayanandraj, S. & Mandal, B. (2016) Cardamom bushy dwarf virus infection in large Cardamom alters plants selection preference, life stages, and fecundity of aphid vector, *Micromyzus kalimpongensis* (Hemiptera: Aphididae). *Environmental entomology*,**45**, 178-184.
- Gillies, M. (1964) Selection for host preference in *Anopheles gambiae*. *Nature*,**203**, 852-854.

- Gillies, M. T. (1980) The role of carbon dioxide in host-finding by mosquitoes (Diptera: Culicidae): a review. *Bulletin of Entomological Research*, **70**, 525-532.
- Githeko, A. K., Adungo, N. I., Karanja, D. M., Hawley, W. A., Vulule, J. M., Seroney, I. K., *et al.* (1996) Some observations on the biting behavior of *Anopheles gambiae s.s.*, *Anopheles arabiensis*, and *Anopheles funestus* and their implications for malaria Control. *Experimental parasitology*, **82**, 306-315.
- Githeko, A. K., Service, M. W., Mbogo, C. M., Atieli, F. K. & Juma, F. O. (1994) Origin of blood-meals in indoor and outdoor resting malaria vectors in western Kenya. *Acta Tropica*, **58**, 307-316.
- Hasselschwert, D. & Rockett, C. L. (1988) Bacteria as ovipositional attractants for *Aedes aegypti* (Diptera: Culicidae). *The Great Lakes Entomology*, **2 (4)**: 319-324.
- Himeidan, Y. E., Temu, E. A., El Rayah, E. A., Munga, S. & Kweka, E. J. (2013) Chemical cues for malaria vectors oviposition site selection: challenges and opportunities. *Journal of Insects*, DOI:10.1155/2013/685182.
- Homan, T., Hiscox, A., Mweresa, C. K., Masiga, D., Mukabana, W. R., Oria, P., *et al.* (2016) The effect of mass mosquito trapping on malaria transmission and disease burden (SolarMal): a stepped-wedge cluster-randomised trial. *Lancet*, **388**, 1193-1201.
- Kassahun, T., Hill, R., Birgersson, G., Tekie, H. & Ignell, R. (2016) Chicken volatiles repel host-seeking malaria mosquitoes. *Malaria Journal*, **15**:354.
- Kelly, M., Su, C. Y., Schaber, C., Crowley, J. R., Hsu, F. F., Carlson, J. R., *et al.* (2015) Malaria parasites produce volatile mosquito attractants. *Mbio*, **6**.
- Lacroix, R., Mukabana, W. R., Gouagna, L. C. & Koella, J. C. (2005) Malaria infection increases attractiveness of humans to mosquitoes. *Plos Biology*, **3**, 1590-1593.
- Lindh, J. M., Kannaste, A., Knols, B. G. J., Faye, I. & Borg-Karlson, A. K. (2008) Oviposition responses of *Anopheles gambiae s.s.* (Diptera: Culicidae) and identification of volatiles from bacteria-containing solutions. *Journal of Medical Entomology*, **45**, 1039-1049.
- Logan, J. G., Birkett, M. A., Clark, S. J., Powers, S., Seal, N. J., Wadhams, L. J., *et al.* (2008) Identification of human-derived volatile chemicals that interfere with attraction of *Aedes aegypti* mosquitoes. *Journal of Chemical Ecology*, **34**, 308-322.

- Lyimo, I. N. & Ferguson, H. M. (2009) Ecological and evolutionary determinants of host species choice in mosquito vectors. *Trends in Parasitology*,**25**, 189-196.
- Lyimo, I. N., Haydon, D. T., Russell, T. L., Mbina, K. F., Daraja, A. A., Mbehela, E. M., *et al.* (2013) The impact of host species and vector control measures on the fitness of African malaria vectors. *Proceedings of the Royal Society B-Biological Sciences*,**280**.
- Mahon, R. & Gibbs, A. (1982) Arbovirus-infected hens attract more mosquitoes. *Viral Diseases in Southeast Asia and the Western Pacific*, 502-504.
- Mauck, K. E., De Moraes, C. M. & Mescher, M. C. (2010) Deceptive chemical signals induced by a plant virus attract insect vectors to inferior hosts. *Proceedings of the National Academy of Sciences of the United States of America*,**107**, 3600-3605.
- Mboera, L. E. G. & Takken, W. (1997) Carbon dioxide chemotropism in mosquitoes (Diptera: Culicidae) and its potential in vector surveillance and management programmes. *Medical and Veterinary Entomology*,**85**, 355-368.
- McBride, C. S., Baier, F., Omondi, A. B., Spitzer, S. A., Lutomiah, J., Sang, R., *et al.* (2014) Evolution of mosquito preference for humans linked to an odorant receptor. *Nature*,**515**, 222-U151.
- Menger, D. J., Otieno, B., de Rijk, M., Mukabana, W. R., van Loon, J. J. A. & Takken, W. (2014a) A push-pull system to reduce house entry of malaria mosquitoes. *Malaria Journal*,**13**, 119.
- Menger, D. J., Van Loon, J. J. A. & Takken, W. (2014b) Assessing the efficacy of candidate mosquito repellents against the background of an attractive source that mimics a human host. *Medical and Veterinary Entomology*,**28**, 407-413.
- Mnzava, A., Mutinga, M. & Staak, C. (1994) Host blood meals and chromosomal inversion polymorphism in *Anopheles arabiensis* in the Baringo District of Kenya. *Journal of the American Mosquito Control Association*,**10**, 507-510.
- Moore, J. (2002) *Parasites and the Behavior of Animals*. Oxford University Press, Oxford.
- Mukabana, W. R., Mweresa, C. K., Otieno, B., Omusula, P., Smallegange, R. C., van Loon, J. J. A., *et al.* (2012) A novel synthetic odorant blend for trapping of malaria and other African mosquito species. *Journal of Chemical Ecology*,**38**, 235-244.

- Mukabana, W. R., Takken, W., Killeen, G. F. & Knols, B. G. J. (2004) Allomonal effect of breath contributes to differential attractiveness of humans to the African malaria vector *Anopheles gambiae*. *Malaria Journal*,**3**.
- Mukabana, W. R., Takken, W. & Knols, B. G. J. (2002) Analysis of arthropod bloodmeals using molecular genetic markers. *Trends in Parasitology*,**18**, 505-509.
- Mweresa, C. K., Omusula, P., Otieno, B., van Loon, J. J. A., Takken, W. & Mukabana, W. R. (2014) Molasses as a source of carbon dioxide for the malaria mosquitoes *Anopheles gambiae* and *Anopheles funestus*. *Malaria Journal*,**13**: 160.
- O'Shea, B., Rebollar-Tellez, E., Ward, R. D., Hamilton, J. G. C., El Naiem, D. & Polwart, A. (2002) Enhanced sandfly attraction to *Leishmania*-infected hosts. *Transactions of the Royal Society of Tropical Medicine and Hygiene*,**96**, 117-118.
- Okumu, F. O., Killeen, G. F., Ogoma, S., Biswaro, L., Smallegange, R. C., Mbeyela, E., *et al.* (2010) Development and field evaluation of a synthetic mosquito lure that is more attractive than humans. *Plos One*,**5**.
- Pates, H. V., Takken, W., Stuke, K. & Curtis, C. F. (2001) Differential behaviour of *Anopheles gambiae sensu stricto* (Diptera : Culicidae) to human and cow odours in the laboratory. *Bulletin of Entomological Research*,**91**, 289-296.
- Ponnusamy, L., Schal, C., Wesson, D. M., Arellano, C. & Apperson, C. S. (2015) Oviposition responses of *Aedes* mosquitoes to bacterial isolates from attractive bamboo infusions. *Parasites & Vectors*,**8**, 1-8.
- Ponnusamy, L., Xu, N., Boroczky, K., Wesson, D. M., Abu Ayyash, L. & Schal, C. (2010) Oviposition responses of the mosquitoes *Aedes aegypti* and *Aedes albopictus* to experimental plant infusions in laboratory bioassays. *J Chem Ecol*,**36**.
- Russell, T. L., Govella, N. J., Azizi, S., Drakeley, C. J., Kachur, S. P. & Killeen, G. F. (2011) Increased proportions of outdoor feeding among residual malaria vector populations following increased use of insecticide-treated nets in rural Tanzania. *Malaria Journal*,**10**.
- Salter, S. J., Cox, M. J., Turek, E. M., Calus, S. T., Cookson, W. O., Moffatt, M. F., *et al.* (2014) Reagent and laboratory contamination can critically impact sequence-based microbiome analyses. *BMC biology*,**12**, 1.

- Schulz, S. & Dickschat, J. S. (2007) Bacterial volatiles: the smell of small organisms. *Natural Product Reports*,**24**, 814-842.
- Smallegange, R. C., Bukovinszky-Kiss, G., Otieno, B., Mbadi, P. A., Takken, W., Mukabana, W. R., *et al.* (2012) Identification of candidate volatiles that affect the behavioural response of the malaria mosquito *Anopheles gambiae sensu stricto* to an active kairomone blend: laboratory and semi-field assays. *Physiological Entomology*,**37**, 60-71.
- Smallegange, R. C., Knols, B. G. & Takken, W. (2010) Effectiveness of synthetic versus natural human volatiles as attractants for *Anopheles gambiae* (Diptera: Culicidae) *sensu stricto*. *Journal of Medical Entomology*,**47**, 338-344.
- Smallegange, R. C., van Gemert, G. J., van de Vegte-Bolmer, M., Gezan, S., Takken, W., Sauerwein, R. W., *et al.* (2013) Malaria infected mosquitoes express enhanced attraction to human odor. *Plos One*,**8**.
- Spitzen, J., Smallegange, R. C. & Takken, W. (2008) Effect of human odours and positioning of CO<sub>2</sub> release point on trap catches of the malaria mosquito *Anopheles gambiae sensu stricto* in an olfactometer. *Physiological Entomology*,**33**, 116-122.
- Sriwichai, P., Samung, Y., Sumruayphol, S., Kiattibutr, K., Kumpitak, C., Payakkapol, A., *et al.* (2016) Natural human *Plasmodium* infections in major *Anopheles* mosquitoes in western Thailand. *Parasites and Vectors*,**9**, 17.
- Suh, E., Choe, D.-H., Saveer, A. M. & Zwiebel, L. J. (2016) Suboptimal larval habitats modulate oviposition of the malaria vector mosquito *Anopheles coluzzii*. *PloS One* **11** (2): e0149800.
- Takken, W. & Verhulst, N. O. (2013) Host preferences of blood-feeding mosquitoes. *Annual Review of Entomology*,**58**, 433-453.
- Thomas, F., Adamo, S. & Moore, J. (2005) Parasitic manipulation: where are we and where should we go? *Behavioural Processes*,**68**, 185-199.
- Thomas, F. & Poulin, R. (1998) Manipulation of a mollusc by a trophically transmitted parasite: convergent evolution or phylogenetic inheritance? *Parasitology*,**116**, 431-436.

- Tirados, I., Costantini, C., Gibson, G. & Torr, S. (2006) Blood-feeding behaviour of the malarial mosquito *Anopheles arabiensis*: implications for vector control. *Medical and Veterinary Entomology*,**20**, 425-437.
- Torr, S., Della Torre, A., Calzetta, M., Costantini, C. & Vale, G. (2008) Towards a fuller understanding of mosquito behaviour: use of electrocuting grids to compare the odour-orientated responses of *Anopheles arabiensis* and *An. quadriannulatus* in the field. *Medical and veterinary entomology*,**22**, 93-108.
- Turell, M. J., Bailey, C. L. & Rossi, C. A. (1984) Increased mosquito feeding on Rift Valley fever virus-infected lambs. *American Journal of Tropical Medicine and Hygiene*,**33**, 1232-1238.
- van Duijvendijk, G., van Anandel, W., Fonville, M., Gort, G., Hovius, J. W., Sprong, H., *et al.* (2016) A *Borrelia afzelii* infection increases larval tick burden on *Myodes glareolus* (Rodentia: Cricetidae) and nymphal body weight of *Ixodes ricinus* (Acari: Ixodidae) *Journal of Medical Entomology*.
- van Loon, J. J. A., Smallegange, R. C., Bukovinszky-Kiss, G., Jacobs, F., De Rijk, M., Mukabana, W. R., *et al.* (2015) Mosquito attraction: Crucial role of carbon dioxide in formulation of a five-component blend of human-derived volatiles. *Journal of Chemical Ecology*,**41**, 567-573.
- Verhulst, N. O., Beijleveld, H., Knols, B. G. J., Takken, W., Schraa, G., Bouwmeester, H. J., *et al.* (2009) Cultured skin microbiota attracts malaria mosquitoes. *Malaria Journal*,**8**.
- Verhulst, N. O., Mbadi, P. A., Kiss, G. B., Mukabana, W. R., van Loon, J. J. A., Takken, W., *et al.* (2011a) Improvement of a synthetic lure for *Anopheles gambiae* using compounds produced by human skin microbiota. *Malaria Journal*,**10**.
- Verhulst, N. O., Mukabana, W. R., Takken, W. & Smallegange, R. C. (2011b) Human skin microbiota and their volatiles as odour baits for the malaria mosquito *Anopheles gambiae* s.s. *Entomologia Experimentalis Et Applicata*,**139**, 170-179.
- Verhulst, N. O., Qiu, Y. T., Beijleveld, H., Maliepaard, C., Knights, D., Schulz, S., *et al.* (2011c) Composition of human skin microbiota affects attractiveness to malaria mosquitoes. *Plos One*,**6**.

- Verhulst, N. O., Takken, W., Dicke, M., Schraa, G. & Smallegange, R. C. (2010) Chemical ecology of interactions between human skin microbiota and mosquitoes. *Fems Microbiology Ecology*,**74**, 1-9.
- Wekesa, J. W., Copeland, R. S. & Mwangi, R. W. (1992) Effect of *Plasmodium falciparum* on blood feeding behavior of naturally infected *Anopheles mosquitoes* in western Kenya. *The American journal of tropical medicine and hygiene*,**47**, 484-488.
- Zouache, K., Fontaine, A., Vega-Rua, A., Mousson, L., Thiberge, J.-M., Lourenco-de-Oliveira, R., *et al.* (2014) Three-way interactions between mosquito population, viral strain and temperature underlying chikungunya virus transmission potential. *Proceedings of the Royal Society B: Biological Sciences*,**281**.





Summary

## Summary

For the first time, interactions between human hosts and their skin microbiota, *Plasmodium* parasites and malaria vectors were investigated through a series of studies shown in this thesis. Skin microbes and malaria parasites were shown to mediate the interaction between vertebrates and arthropod vectors with different host preferences. This interaction could lead to improvement of existing odour-baited traps, which has become a viable option for vector control (Homan *et al.*, 2016). In order to understand the role of microorganisms in mediating the response of mosquitoes with different host preferences, three research questions were studied: (1) Do volatiles produced by skin bacteria play a role in species-specific host preference of mosquitoes? (2) Does infection with gametocytes of *Plasmodium* increase the attractiveness of humans to malaria mosquitoes? and (3) What is the mechanism through which *Plasmodium* influences human attractiveness to malaria mosquitoes? The results are summarized below.

In **Chapter 2**, I investigated the response of mosquitoes with different host preferences to natural host odours and synthetic odour blends in a screenhouse and outdoors, in a malaria-endemic area in western Kenya. Both experiments tested the attractiveness of chicken, cow and human odours and odour blends that consisted of three compounds (the standard blend) or five compounds (MB5) previously identified and released with carbon dioxide to the anthropophilic *Anopheles gambiae sensu stricto* and the more opportunistic *An. arabiensis*. Semi-field results showed that both *An. gambiae* and *An. arabiensis* were significantly more attracted to human odours. However, *An. arabiensis* also responded to cow and chicken odours, which confirmed its opportunistic behaviour in Kenya. The MB5 blend was highly attractive to both mosquito species. In the field, the MB5 odour blend attracted significantly more *An. funestus* than human odour, while no difference was found for *An. arabiensis*, the dominant species of the *An. gambiae sensu lato* in the study area. Most of *An. arabiensis* and *Culex spp.* fed outdoors on cow blood. These results show that mosquito species express differences in their response to host odours, with variation between host species and odour blends, and this is dependent on the set up of the geographical area.

In **Chapter 3**, bacterial volatiles from the skins of three natural hosts, human, cow and chicken, were collected and grown on agar plates. Attractiveness of volatiles released from clean agar (control) and skin bacteria was tested in a screenhouse using *An. gambiae s.s* and *An. arabiensis*. Result showed that, in addition to *An. gambiae*, *An. arabiensis* also responds to skin bacterial volatiles, and that both mosquito species can distinguish between volatiles from bacteria collected from different host species. Bacterial volatiles, however, induced differential responses of the two mosquito species, which matched their response to the host odours themselves studied in Chapter 2, *i.e.* both mosquito species had a preference for bacterial volatiles from humans compared to volatiles from other hosts, although this effect was stronger for the more anthropophilic *An. gambiae*. In contrast to *An. gambiae*, *An. arabiensis* responded equally to all individual bacterial species tested, which may be explained by its more opportunistic feeding behaviour in Kenya. Analysis and identification of specific skin bacterial species and the compounds produced by skin bacteria from the three hosts (human, chicken and cow) would be important in the development of a standardised synthetic odour blend that can trap both the anthropophilic and more opportunistic mosquitoes. This approach would reduce mosquito populations, and hence, vector-borne diseases.

In **Chapter 4**, we review how various parasites manipulate their vectors as well as their vertebrate hosts in order to enhance their transmission. The focus was on humans who were more attractive to malaria mosquitoes compared to their less-attractive counterparts. Our literature search and past experiments, including Chapter 5 of this thesis showed that people who harbour microscopic gametocytes of *Plasmodium* are significantly more attractive to malaria mosquitoes than submicroscopic gametocyte carriers, asexual carriers or malaria-free individuals before antimalarial treatment of infected children. We explored the possible mechanisms involved in attractiveness of gametocyte carriers by in-depth discussion on the possibility of the malaria parasites to produce attractive volatiles that may play a role in the attractiveness of humans infected with the sexual stage (gametocytes) of *Plasmodium* parasites, and suggest that the increased attractiveness of the gametocyte carriers may be due to manipulation of the skin bacterial profile of this group of people, by malaria parasites, which modify the VOCs of people harbouring gametocytes and not the non-microscopic

gametocyte carriers. We also suggest that *Plasmodium* parasites could induce upregulation of the existing host-seeking cues, which may deceive malaria vectors and result in increased attractiveness of infected vertebrate hosts. We conclude with suggestions to include volatile analyses of skin bacteria from gametocyte and non-gametocyte carriers, for identification of compounds attractive to mosquitoes.

**Chapter 5** describes a dual-choice olfactometer experiment using four groups of Kenyan school children, malaria-free, asexual, submicroscopic or microscopic gametocyte carriers aged 5-12 years, versus a standardised human odour. All children were screened for presence of malaria parasites using microscopy and two molecular techniques, PCR and QT-NASBA, at two time-periods, during infection and after treatment of infected children with artemisinin-lumefantrine. Only the malaria-free children were recruited in the study based on PCR results. Our findings showed that children attracted higher numbers of mosquitoes than the standardised human odour. Additionally, higher attractiveness of malaria-infected persons, (two times more in microscopic gametocyte carriers) is dependent on higher levels of gametocytaemia, compared to children without gametocytes or with low levels of gametocytaemia. Further, not only body odours, but also breath could have contributed to increased attractiveness of microscopic gametocyte carriers before antimalarial treatment. Additional results showed that the attractiveness of the microscopic gametocyte carriers was not influenced by their age and gender, and did not differ significantly with that of the other groups after treatment of infected children with antimalarials (21 days post-treatment). Findings from this study suggest that significantly highly attractive people are bitten more than the less attractive people, and our results could be used in mathematical models, in predicting and planning interventions towards the gametocyte carriers. This includes budgeting for transport costs, purchase of malaria screening equipment and antimalarial drugs, which would result in reductions in transmission of malaria. Further analysis and identification of specific compounds produced by skin bacterial volatiles from the most attractive gametocyte carriers and testing the attractiveness of the compounds identified, will provide information on volatiles that are attractive to mosquitoes. This may result in improvement of the existing synthetic odour blends like the MB5 blend that was used to trap mosquitoes on Rusinga Island, Western Kenya.

**Chapter 6** utilised a dual-choice cage assay in determining the mechanism underlying attractiveness of Kenyan children (studied in Chapter 5) infected with the transmissible stage of *P. falciparum* (gametocytes). Relative comparisons were done to determine the response of malaria mosquitoes to i) body odours (worn nylon socks) and ii) skin bacterial volatiles (from the lower back), from the same child at two time periods, before and after treatment of infected children. Body odours from malaria-infected children were significantly more attractive to malaria vectors compared to body odours from the same children after medication, or to volatiles from malaria-free children. Odours from malaria-free children did not differ significantly during the two time-periods. The attractiveness of the microscopic gametocyte carriers studied in Chapter 5 (a combination of breath and body odours) and Chapter 6 (using body odours only) matched. Additionally, body odours of submicroscopic and asexual carriers were attractive to malaria vectors in the cage assay, but not in the olfactometer experiment before antimalarial treatment, which suggests manipulation of body odours by *Plasmodium* parasites to increase host odour attractiveness. The cage assay could be sensitive to small differences in skin volatiles of the same child at the two time-periods, which could have made the body odours of malaria-infected children attract high numbers of mosquitoes. In the bacterial experiment, the attractiveness of skin bacterial volatiles from malaria-free and infected children did not differ, but this does not preclude the role of skin bacterial volatiles in malaria-mediated attraction of mosquitoes. Future research should therefore aim at identification of bacterial species, their diversity and compounds emitted by bacteria, which could be tested for attractiveness to mosquitoes. This may lead to the development of new odour baits or improvement of the existing synthetic odour blends. The role of breath in attractiveness of gametocyte carriers should also be investigated.

The final chapter of this thesis provides a general discussion and conclusions of previously unanswered questions on the role of microorganisms in mediating response of mosquitoes with different preferences and the underlying mechanisms. We showed that skin bacteria mediate odour production, and mosquitoes with different host-preferences respond differently to each odour. We further showed that infection with high gametocyte densities of *Plasmodium* enhances attractiveness of humans to malaria mosquitoes and body odours play

a significant role in the attractiveness of malaria-infected hosts. The results provided in this thesis create new opportunities for future experimentation.

The main conclusions from this thesis are summarised as follows: Skin bacterial volatiles play an important role in guiding mosquitoes with different host preferences to their specific host. Within species, an infection with high densities of *Plasmodium* microscopic gametocytes results into higher attractiveness of hosts to malaria vectors. Identification of general or common attractive volatiles produced by the natural hosts, cattle, human, chickens as well as those from the gametocyte carriers may contribute to the development of a new standardized synthetic odour blend that may be used for sampling of mosquitoes with different host preferences. The use of powerful attractive odorants may result in reductions of vector-borne diseases caused by mosquitoes.

## Acknowledgements

My PhD journey was challenging and at times frustrating. Despite these, I can look back with a lot of contentment in my achievement after the valuable experiences. This work reflects the contribution and support of many people who I met along the way. First, I appreciate my promoter and supervisor Prof. Willem Takken. Thank you for the PhD position, support, professional guidance and the interest you always had in my work, even when you were unwell. To my supervisors Dr(s) Jetske de Boer and Niels Verhulst, thanks for your time and guidance that were integral to the completion of my project. The wise counsel you offered, kind indulgence and painstaking assistance in correcting this work are highly acknowledged. I felt so lucky to have the opportunity to work with and learn from these world class scientists, with work ethics. Your criticisms, firm but friendly brainstorming sessions, recommendations and mentorship have made me become a seasoned independent scientist. The grants that supported my PhD research work are highly appreciated.

In Kenya, I acknowledge the Director General, International Centre of Insect Physiology and Ecology (*icipe*), for granting me the opportunity to carry out my research at *icipe*, and the Director for Research and Partnerships-Capacity Building for organizing my study under *icipe's* Dissertation Research Internship Programme (DRIP). Special thanks go to Dr(s) Collins Mweresa and Daniel Masiga for their constructive comments, suggestions, discussions and encouragement. The contributions of Dr. Ulrike Fillinger and the Mbita Science Club-*icipe*, which I coordinated for one year, are appreciated for the scientific discussions. Uli, thank you for the laboratory facility you provided for my molecular work. I thank the *icipe*-Mbita staff, administration and the *icipe* workshop manager, Mr. Peter Nyongesa for creating a conducive and supportive environment for executing my research work.

Many thanks go to Dr. Susan Imbahale, who initially introduced me to the world of mosquitoes, and Prof. Wolfgang Mukabana for mentorship and fabricating the modified olfactometer used in part of my experiments. Faith Kyengo is appreciated for logistical support while Mr. Fred Kisanya and Dr. Imbahale are thanked for provision of laboratory facility during my field work in Ahero, Kenya. Gratitude goes to Geoffrey Omondi for malaria screening and for the long hours spent under the microscope. Sally Mongoi of Kenya



Medical Research Institute (KEMRI) and Paul Omondi are thanked for re-reading the project slides.

I am particularly indebted to Charles, Philemon and Joseph Ogacho for their support in field work. Antony Kibet is highly appreciated for his help in the molecular technique, PCR. Gratitude goes to parents/guardians of the olfactometer volunteers and the volunteers for their participation in part of the experiments. To the drivers, Jackton, Charles and William, thanks for your time and patience! David Alila and Elisha Kobudho are appreciated for the supply of experimental mosquitoes. Lawrence Okombo is acknowledged for sacrificing his short holiday to help with cage assays. To Tessa van Dijk, an MSc student who did her thesis research on this topic, your contribution is highly acknowledged. Ailie Robinson, Sopher Ondiaka, Marieke de Swart and Sean Sauren are also appreciated for useful discussions. Tessa and Marieke, thanks for the beautiful moments that we enjoyed in Mbita. Our trips and walk in Kakamega forest-Kenya and a visit to your parents' homes and walk in the forest in the Netherlands were the most interesting breaks from work. I am grateful to Alexandra Hiscox, Ibrahim Kiche, Francis Okomo, Prisca Oriah, Margaret Ayugi, and donors of body odours and skin bacteria used in my experiments. Joseph Nalyanya, Evans Akhanala, Dr(s) Stephen Munga, Patrick Sawa, Charles Midega and Yaw Afrane, your encouragement is highly appreciated.

Back in the Netherlands, I met a number of people who became friends and colleagues. First, I commend Marion Rodenburg, Jacqueline de Graaff, Angelique Bosch and Jetske for ensuring that my travel and housing arrangements were done on time. Chantal Vogels is appreciated for being my buddy while in the Netherlands. I give thanks to Françoise and family for welcoming me at their home, and for the first Christmas dinner in Holland. Gratitude goes to Jetske for her welcome to Holland. Appreciation goes to your family for the weekend trips we enjoyed together; Max, Rosa and Orlando, thanks. The delicious Dutch dinners and the games I enjoyed playing with your family and that of Niels are highly appreciated. Thanks for introducing me to the world's scientific experts, Dr(s) Teun Bousema, James Logan, Robert Sauerwein, Beatrice Hahn and Dorothy Loy. Gratitude goes to them for the useful discussions, suggestions and for further analysis of research samples. To PhD students and colleagues at the Laboratory of Entomology, thanks for the good working atmosphere you provided and the discussions held during coffee breaks, parties, labuitje and colloquia.

Many thanks to the vector group for their useful discussions and new ideas during the weekly meetings. I am indebted to appreciate Jeroen Spitzen and Sander Koenraadt for their interest in my work, suggestions and discussions while writing my thesis. Together with Jetske and Niels, you made a significant contribution to the introduction and discussion chapters of my thesis! Saskia Burgers is specially thanked for guidance in analysis of part of data sets in this thesis. Dr(s) Claudius van de Vijver and Lennart Suselbeek of the Graduate school for Production Ecology and Resource Conservation (PE & RC) are acknowledged for organizing the PE & RC courses and weekends. Special gratitude goes to my paranymphs Niels and Tessa for their role during my PhD defense.

To the Kenyan community in the Netherlands, the ICF church, including Carolien Koos and Laurensia Yuniati, and my friends Monicah Mirai, Prisca Oria, Victor Mwingira and Emmanuel Hakizimana, thanks for ensuring we all felt at home despite the many miles away from Africa. Special thanks go to my father, Benn Shihugwa and my mother, Rose Shihugwa for their very tireless and credible support throughout my academic journey. I am what I am today because of the wisdom, courage and discipline you passed on to me at a younger age. Your efforts in the little Annette, in over 30 years, have resulted in a dependable scientist you can appreciate. Your emphasis on ‘Hurry has no blessings but patience pays’, has resulted in my success.

To my siblings: Maxwell Busula, David Muhati, Bilha Khatushi, Isaac Wabuko and Solomon Segero, thanks for your love, encouragement, support and prayers that enabled me meet my dreams! Thanks to my sisters in-law Esther Busula and Linnet Shimaka Muhati; Linnet, thanks for hospitality! My nieces Abigael Malesi, Blessing Martha, Caileen-Rose Busula, Nicole Malesi, Karsten Shimuli, Zaylee Aviana, Kaylah Otia, Thalma Akamuran and nephews, Oxylicious Oteba and Branson-Benn Busula, your frequent calls while abroad were encouraging. For you and my future generation, remind me of a copy of my PhD book when you are of age; an evidence of my hard work; may it be a motivation to you! My special friends Lavendar Agutu, Elizabeth Masinde, Monicah Mirai, Roselyn Sumba, Sally Mongoi, Margaret Okumu and Bostley Asenahabi, thanks for your sense of humour, encouragement and prayers at the time I needed them most! To them that I have not mentioned, I say thank you for your support.

Annette O. Busula.



## Curriculum vitae

On 2nd December 1981, Annette Obukosia Busula was born in Bwimalia village, Kakamega County, western Kenya. She sat for her final primary exams at Musingu primary school in 1996. Annette joined the Sacred Heart-Mukumu girls' high school for her secondary education in 1997. She later joined Moi University, Chepkoilel campus (currently the University of Eldoret), Kenya in 2002, where she graduated with a Bachelor of Science degree in Botany and Zoology in 2006. Thereafter, Annette was temporarily employed as a secondary teacher at St. Francis Xavier-Shipalo. In 2007, she secured a post-graduate attachment at the Kenya Medical Research Institute (KEMRI)-Kisumu. Annette further worked as a research assistant in KEMRI, on Dr. Susan Imbahale's PhD project titled 'Integrated water management, agriculture and malaria mosquitoes'. It is here that she developed an interest in medical Entomology and Parasitology. Through Dr. Imbahale's mentorship and supervision, together with Prof. Wolfgang Mukabana, Annette graduated from the University of Nairobi with a Master of Science degree (MSc) in applied parasitology, in 2012. Her MSc research work titled 'Experimental infection of malaria mosquitoes with the entomopathogenic fungus, *Beauveria bassiana* and *Metarhizium anisopliae* under field conditions' was funded by the Adessium foundation, the Netherlands. In 2013, Annette was employed by *icip*e as a consultant on a malaria project which aimed at reducing the survival of the mosquito vector, by use of the entomopathogenic fungi. She also worked as a research assistant on malaria projects which focused on mosquito host-seeking behaviour and chemical signalling of malaria parasites, which involved collection of body odours, skin bacteria and skin volatiles from Kenyan children in Mbita, Homabay County. Annette also worked as a lecturer of Biological sciences at Jaramogi and Masinde Muliro Universities of Science and Technology, Kenya. While in *icip*e, Annette received a PhD scholarship from Prof. Willem Takken, to study the microorganism-mediated behaviour of malaria mosquitoes, at Wageningen University, the Netherlands, in collaboration with *icip*e-Kenya where she executed her research work. During her study, she won a travel award and a prize for the best talk at the British Society of Parasitology meeting, at Imperial College, London. The book you are reading now is the outcome of her hard work.



*Correspondence: obukosia@yahoo.com*

## List of publications

Busula A.O., Takken W, Loy D.E, Hahn B.H, Mukabana W.R and Verhulst N.O. 2015. Mosquito host preferences affect their response to synthetic and natural odour blends. *Malaria Journal* 14:133.

Busula A.O., Takken W, de Boer J.G, Mukabana W.R, Verhulst N.O. Variation in host preference of malaria mosquitoes is mediated by skin bacterial volatiles. *Medical and Veterinary Entomology* (accepted, 2017).

Busula A.O, Bousema T, Mweresa C, Masiga D, Logan J.G, Sauerwein R.W, Verhulst N.O, Takken W and de Boer J.G. Gametocytaemia increases attractiveness of *Plasmodium falciparum*-infected Kenyan children to *Anopheles gambiae* mosquitoes. *Journal of Infectious Diseases* (accepted 2017).

Busula A.O, Verhulst N.O, Bousema T, Takken W and de Boer J.G. Mechanisms of vertebrate-host manipulation by malaria parasites: a review (In preparation).

## **PE&RC PhD Education Certificate**

With the training and education activities listed below the PhD candidate has complied with the requirements set by the C.T. de Wit Graduate School for Production Ecology and Resource Conservation (PE&RC) which comprises of a minimum total of 32 ECTS (= 22 weeks of activities)

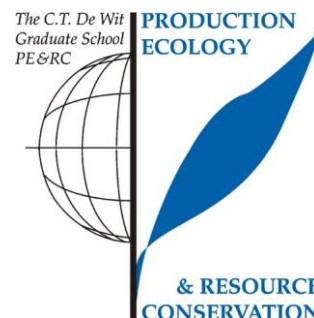

### **Review of literature (6 ECTS)**

- Microorganism - mediated behaviour of malaria mosquitoes

### **Writing of project proposal (4 ECTS)**

- Microorganism - mediated behaviour of malaria mosquitoes

### **Post-graduate courses (3 ECTS)**

- Multivariate analysis; PE&RC (2014)
- Behavioural and chemical ecology; International Centre of Insect Physiology and Ecology, *icipe* (2015)

### **Deficiency, refresh, brush-up courses (6 ECTS)**

- Analysis and prevention of health risks in the tropical countries (2014)
- Ecological aspects of biological interactions (2014)

### **Competence strengthening / skills courses (4 ECTS)**

- PhD Competence assessment; WGS (2014)
- Information literacy, including EndNote; Wageningen UR Library (2014)
- Project and time management; WGS (2014)
- The essential of scientific writing and presenting; Wageningen into Languages (2014)

### **PE&RC Annual meetings, seminars and the PE&RC weekend (1.8 ECTS)**

- PE&RC Weekend (2014)
- PE&RC Last year's weekend (2016)
- 3<sup>rd</sup> Wageningen PhD symposium on diversity in science (2016)

### **Discussion groups / local seminars / other scientific meetings (9.7 ECTS)**

- Local seminars and meetings on integrated vector control; Kenya and the Netherlands (2013-2016)
- 26<sup>th</sup> Annual meeting of the Netherlands Entomological Society; the Netherlands (2014)
- College Tour Bill Gates on funding research for tropical disease (2014)
- Vector group meetings at the Laboratory of Entomology; the Netherlands (2014, 2016)
- PhD Students discussion group at the Laboratory of Entomology, the Netherlands (2014, 2016)
- WEES Lectures; Wageningen University, the Netherlands (2014, 2016)
- Dutch arboviral network workshop on one health approach on emerging European arboviruses; the Netherlands (2016)

### **International symposia, workshops and conferences (6.9 ECTS)**

- Vector biology meeting; *icip*e, Mbita, Kenya (2015)
- The British Society for Parasitology (BSP): from science to solutions, optimising control of parasitic diseases; Imperial College, London (2016)
- Malaria: from innovation to elimination (B5); Kampala, Uganda (2017)

### **Lecturing / supervision of practicals / tutorials (3 ECTS)**

- Medical and veterinary parasitology (2014)
- Immunology (2014)

### **Supervision of MSc students (3 ECTS)**

- The effects of anti-malarial and host age on host-seeking behaviour of *Anopheles gambiae* and *Anopheles arabiensis*
- Effect of malaria infection on human skin bacteria and attractiveness of skin bacteria to mosquitoes

Thesis layout: Annette O. Busula

Cover design: Annette O. Busula and Jetske de Boer

Cover pictures: Jetske de Boer, Niels Verhulst and Ailie Robinson

Printed by: GVO drukkers & vormgevers B.V, EDE